



GEOTECHNICAL INVESTIGATION
CHEVRON GULF OF MEXICO GAS HYDRATES JIP
BLOCKS 13 AND 14, ATWATER VALLEY AREA
BLOCK 151, KEATHLEY CANYON AREA
GULF OF MEXICO

RESULTS OF CORE SAMPLE ANALYSIS,
STANDARD AND ADVANCED LABORATORY TESTING

Report No. 0201-5081

CHEVRON TEXACO ENERGY TECHNOLOGY COMPANY
Houston, Texas

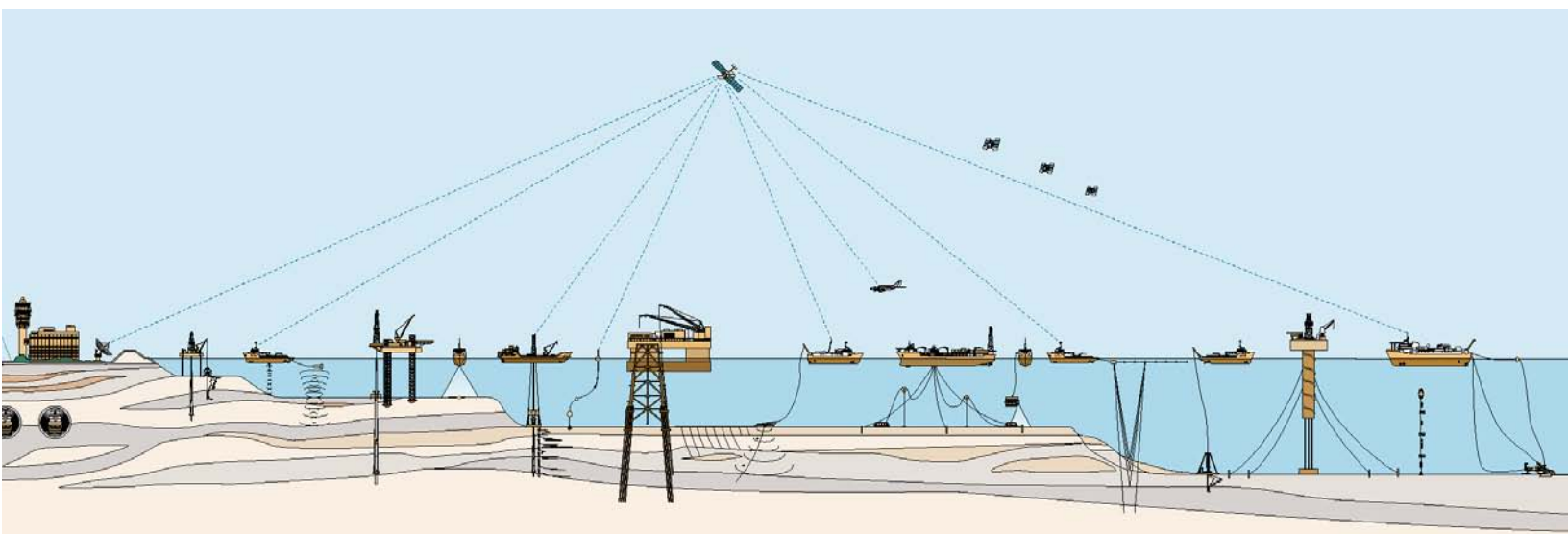



GEOTECHNICAL INVESTIGATION

**CHEVRON GULF OF MEXICO GAS HYDRATES JIP
BLOCKS 13 AND 14, ATWATER VALLEY AREA
BLOCK 151, KEATHLEY CANYON AREA
GULF OF MEXICO**

**RESULTS OF CORE SAMPLE ANALYSIS,
STANDARD AND ADVANCED LABORATORY
TESTING**

REPORT NO. 0201-5081

Client: ChevronTexaco Energy Technology Company
1500 Louisiana St.
Houston, Tx 77002

Date of Cruise: April 17 through May 22, 2005

Date of Report: February 25, 2006



FUGRO-McCLELLAND MARINE GEOSCIENCES, INC.

Report No. 0201-5081
February 25, 2006

ChevronTexaco Energy Technology Company
1500 Louisiana St.
Houston, TX 77002

6100 Hillcroft (77081)
P.O. Box 740010
Houston, TX 77274
Phone: 713-369-5600
Fax: 713-369-5570

Attention: Mr. Emrys Jones
Mr. George E. Claypool (U of California)

GEOTECHNICAL INVESTIGATION GULF OF MEXICO GAS HYDRATES JIP BLOCKS 13 AND 14, ATWATER VALLEY AREA - BLOCK 151, KEATHLEY CANYON AREA GULF OF MEXICO

RESULTS OF CORE SAMPLE ANALYSIS, STANDARD AND ADVANCED LABORATORY TESTING

Fugro-McClelland Marine Geosciences, Inc. (FMMG) was contracted by ChevronTexaco Energy Technology Company to serve as general contractor during the ChevronTexaco Gas Hydrates JIP program. The campaign was conducted from the semi-submersible drilling vessel MSV *Uncle John* during the period April 17 through May 22, 2005.

This report presents the final results of the field and onshore laboratory testing phases of this investigation, which includes general discussions of operational and sampling aspects of the field phase, and procedures and results of the standard and advanced laboratory programs performed on a few selected samples obtained from **Borings AT13#2** and **KC151#3**.

We appreciate the opportunity to have been of service to you on this project. Please do not hesitate to contact us if you have any questions or if we can be of further assistance.

Sincerely,

FUGRO-MCCLELLAND
MARINE GEOSCIENCES, INC.

Fabian W. Hippe
Geotechnical Project Engineer

Gary D. Humphrey, P.E.
Deepwater Project Manager

Ko-Min Tjok, P.E.
Senior Supervising Engineer

TABLE OF CONTENTS

SECTION I:	FIELD AND LABORATORY INVESTIGATION
SECTION II:	EVALUATION OF STATIC SOIL PROPERTIES

APPENDICES

APPENDIX A:	FIELD INVESTIGATION
APPENDIX B:	LABORATORY SOIL TESTING PROGRAM
APPENDIX C:	X-RAY RADIOGRAPHS
APPENDIX D:	POSITIONING REPORT by FUGRO CHANCE, Inc.

SECTION I
FIELD AND LABORATORY INVESTIGATION

**FIELD AND LABORATORY INVESTIGATION
CONTENTS**

	<u>Page</u>
SUMMARY	I-i
INTRODUCTION.....	I-1
Project Description	I-1
Objectives and Scope of Work.....	I-1
Report Format.....	I-2
FIELD INVESTIGATION	I-3
Introduction	I-3
Positioning.....	I-3
Exploratory Borings.....	I-3
Drilling Equipment and Procedures	I-4
Sediment Coring	I-5
ROV Surveys and ROV Push Cores.....	I-8
Advanced Piston Corer Temperature Tool	I-9
Water Depth Measurements	I-9
Water Sampling.....	I-10
LABORATORY INVESTIGATION.....	I-11
Conventional Laboratory Testing	I-11
Offshore Testing.....	I-11
Onshore Testing.....	I-12
Specialized Laboratory Testing.....	I-13
Advanced Static Laboratory Testing.....	I-13
Sample Quality.....	I-13
GENERAL SOIL CONDITIONS	I-14

**FIELD AND LABORATORY INVESTIGATION
TABLES AND ILLUSTRATIONS**

	<u>Plate</u>
General Location Map	I-1
Log of Boring and Test Results	
Boring AT13#2	I-2
Boring KC151#3	I-3
ROV Push Core RV PC#2 (AT14)	I-4
ROV Push Core RV PC#7 (AT14)	I-5
ROV Push Core RV PC#2 (KC151)	I-6
Terms and Symbols Used on Boring and Drop Core Logs	I-7
APCT Test Data,	
APCT Deployment Boring AT13#2	I-8
APCT Deployment Boring KC151#3	I-9
APCT Deployment Boring ATM1	I-10
APCT Deployment Boring ATM4	I-11
SEABIRD CTD Data,	
SEABIRD CTD Cast at AT13#1	I-12
SEABIRD CTD Cast at AT13#2	I-13
SEABIRD CTD Cast at KC151#3	I-14

SUMMARY

Fugro-McClelland Marine Geosciences, Inc. (FMMG) was contracted by ChevronTexaco to provide drilling and geotechnical coring services during the final stage of the ChevronTexaco Gulf of Mexico Gas Hydrates Joint Industry Project (JIP). The main objective of the JIP cruise was to "... collect sediment cores and a full suite of well logs on seismically well-characterized sediments that showed evidence of occurrence of gas hydrates. ..." (Claypool, 2005). This cruise marked the final phase of the 4-year strategic research into hydrate-bearing sediment project funded by the JIP and the Department of Energy, and managed by ChevronTexaco. Pre-cruise seismic data and analysis were used to identify two (2) areas with the potential to bear significant amounts of gas hydrates saturated sediments. One of the areas is located in the Mississippi Canyon, in Blocks 13 and 14 of the Atwater Valley (AT) Area, and the other located on the Continental Slope, in Block 151 of the Keathley Canyon (KC) Area, Gulf of Mexico.

The scientific research investigation was performed from the dynamically positioned semi-submersible drilling vessel MSV *Uncle John* during the period April 17 through May 22, 2005. The fieldwork comprised drilling a total of seven (7) exploratory borings to final penetrations ranging from 26.8 m (88 ft) to 459.3 m (1,507 ft). Of the seven (7) exploratory borings, three (3) were drilled for downhole logging-while-drilling and measurement-while-drilling (LWD/MWD) operations, and the remaining four (4) borings were drilled to obtain soil samples for laboratory analyses. In addition, two (2) of these sample borings were logged using Schlumberger's wireline logging tool upon reaching termination depth, and prior to abandoning the holes. A remotely operated vehicle (ROV), operated by Canyon Offshore, Inc., was also used to (1) survey the seafloor prior to sub-bottom operations, (2) obtain near-seafloor water and sub-bottom soil samples, and (3) aid in positioning and well-control / monitoring operations during sub-bottom operations of the campaign. A conductivity, temperature and depth (CTD) profiler, deployed to the seafloor using the Halibut basket was used to record the water temperature and salinity in the water column and close to the seafloor, and average sound velocity profile. The average sound velocity profile was used in the calibration of the sub-surface positioning system. Fugro Chance, Inc. (CHANCE) of Houston, Texas, provided surface and sub-surface positioning onboard the semi-submersible, utilizing the STARFIX NAV Suite, including STARFIX HP as the primary positioning source and a Sonardyne Big Head LUSBL (Long and Ultra-Short Baseline) system.

The seven (7) exploratory borings were designated as AT13#1, AT13#2, AT14#1, ATM1, ATM4, KC151#2 and KC151#3 by ChevronTexaco and the chief scientist, Dr. George Claypool, based on their relative position and well number (e.g., AT13 stands for Atwater Valley Area, Block 13, and #1 is referenced to Well #1 location).

A total of twenty (20) near-seafloor sub-bottom ROV push cores were attempted using Fugro's ROV Push Sampler. Of the twenty (20) ROV push cores, seven (7) produced no recovery. Three (3) cores were processed and tested onboard the vessel by Fugro's engineers and soil technicians. The remainder of the ROV push cores were retained and used for additional laboratory analyses by the JIP scientists onboard the vessel and post-cruise in one of the laboratory facilities of the involved scientific party.

FMMG performed a program of standard laboratory testing on selected sub-samples from Borings AT13#2 and KC151#3, as well as on three (3) ROV push core samples. A subsequent program of advanced laboratory testing was performed at Fugro's Houston laboratory upon completion of the fieldwork. Laboratory tests performed on samples provided to Fugro during the cruise, as well as additional samples provided to Fugro upon post-cruise sub-sampling in San Diego, California, corresponded to testing requests outlined by Brandon Dugan of Rice University. Laboratory tests performed offshore and onshore pertained to obtaining pertinent index and strength parameters of the soils encountered in the deep Borings AT13#2 and KC151#3, as well as the ROV push Cores PC#2 and PC#7 from Block 14 of the Atwater Valley Area, and PC#2 from Block 151 of the Keathley Canyon Area.

INTRODUCTION

Project Description

Fugro-McClelland Marine Geosciences, Inc. (FMMG) was contracted by ChevronTexaco to provide drilling and geotechnical coring services during the final phase of the ChevronTexaco Gulf of Mexico Gas Hydrates Joint Industry Project (JIP). Two areas, located in the Atwater Valley and the Keathley Canyon Area, in the deepwater frontier of the Gulf of Mexico, were targeted during this investigation. A general location map of the study sites is presented on [Plate I-1](#). The ChevronTexaco Gas Hydrates JIP Drilling Program was part of the NSF funded project entitled *Characterizing Natural Gas Hydrates in the Deep Water Gulf of Mexico: Applications for Safe Exploration and Production Activities*. The objective of this program was to collect sediment cores and seismic downhole data (i.e., LWD/MWD and wireline logs) needed to assess the occurrence and concentration of gas hydrates at several key sites within the Gulf of Mexico (i.e., Atwater Valley and Keathley Canyon Area).

Objectives and Scope of Work

The objective of this JIP Hydrate Drilling Program is described by the JIP chief scientist, George E. Claypool of Scripps Institution of Oceanography, University of California, San Diego, as follows:

“The main objective of the JIP cruise was to collect sediment cores and a full suite of well logs on seismically well-characterized sediments that showed evidence of occurrence of gas hydrates. (...) Results from the JIP cruise are providing improved capability to predict and control potential hazards that gas hydrates pose to deep-water drilling operations.”

(G. Claypool, Chief Scientist)

To accomplish this objective, the following tasks were performed:

Atwater Valley Area, Block 13

- (1) Drilling of one (1) boring, designated Boring AT13#1, to a penetration of 246.6 mbsf (809 ft) using Schlumberger's suite of LWD/MWD instruments to collect continuous downhole logs of seismic data relevant for gas hydrates characterization;
- (2) Drilling of one (1) deep soil boring, designated Boring AT13#2, to a penetration of 199.9 mbsf (656 ft) to explore the subsurface stratigraphy and obtain soil samples for laboratory analysis;
- (3) Near-seafloor sub-bottom ROV push cores were taken to explore the near-seafloor stratigraphy and obtain soil samples for laboratory analyses in areas of particular interest to the JIP program (i.e., seafloor gas expulsion features) in close proximity to the exploratory boring locations;

Atwater Valley Area, Block 14

- (4) Drilling of one (1) boring, designated Boring AT14#1, to a penetration of 286.5 mbsf (940 ft) using Schlumberger's suite of LWD/MWD instruments to collect continuous downhole logs of seismic data relevant for gas hydrates characterization;
- (5) Drilling of two (2) shallow soil borings, designated Boring ATM1 and ATM3, to penetrations of 26.8 mbsf (88 ft) and 29.0 mbsf (95 ft) to explore the subsurface stratigraphy and obtain soil samples for laboratory analysis;

- (6) Near-seafloor sub-bottom ROV push cores were taken to explore the near-seafloor stratigraphy and obtain soil samples for laboratory analyses in areas of particular interest to the JIP program (i.e., seafloor gas expulsion features) in close proximity to the exploratory boring locations;

Keathley Canyon Area, Block 151

- (7) Drilling of one (1) boring, designated Boring KC151#2, to a penetration of 459.3 mbsf (1,507 ft) using Schlumberger's suite of LWD/MWD instruments to collect continuous downhole logs of seismic data relevant for gas hydrates characterization;
- (8) Drilling of one (1) deep soil boring, designated Boring KC151#3, to a penetration of 438.9 mbsf (1,440 ft) to explore the subsurface stratigraphy and obtain soil samples for laboratory analysis; and
- (9) Near-seafloor sub-bottom ROV push cores were taken to explore the near-seafloor stratigraphy and obtain soil samples for laboratory analyses in areas of particular interest to the JIP program (i.e., seafloor gas expulsion features).

Report Format

A summary of the field operations and the results of the investigation, as relate to work conducted by FMMG during the 35-day CVX JIP Gas Hydrates Drilling Program, are presented in this single-volume report.

This report focuses solely on the details of the geotechnical investigation and a summary of the soil conditions encountered at the two (2) core boring locations AT13#2 and KC151#3 based on field and onshore laboratory data. Section I details the geotechnical investigation and a summary of the soil conditions encountered at the two (2) soil boring locations based on field and onshore laboratory data from standard and advanced laboratory tests performed on a few selected samples. Also included in to Section I are logs of three (3) ROV push cores that were recovered from the AT14 and KC151 locations. Section II contains a general discussion of static soil properties.

Four (4) appendices are included in this report. [Appendix A](#) presents details of the field investigation. [Appendix B](#) pertains to the field and onshore laboratory test data and procedures. [Appendix C](#) presents the X-ray radiographs performed on thirteen (13) whole-core sub-samples provided to FMMG for laboratory testing. [Appendix D](#) contains the positioning report prepared by Fugro Chance, Inc. (CHANCE) of Houston, Texas.

FIELD INVESTIGATION

Introduction

The scientific research investigation was performed from the dynamically positioned semi-submersible drilling vessel MSV *Uncle John* during the period April 17 through May 22, 2005. The MSV *Uncle John* is equipped with a Ceglec DPS 902 Duplex dynamic positioning system that holds the vessel on station by means of a controlled propulsion system, which counteracts the external forces that tend to move the vessel off position. The vessel is owned and operated by Cal Dive International. FMMG provided the drilling personnel, geotechnical engineers, soil technicians, electrical-mechanical technician, and equipment for sediment coring and field laboratory testing. A chronological Summary of Field Operations is presented in [Appendix A](#)

Positioning

Fugro Chance, Inc. (CHANCE) of Houston, Texas, provided surface and sub-surface positioning services onboard the MSV *Uncle John* utilizing the STARFIX Differential GPS positioning system, including the Starfix HP as the primary positioning source. The positioning services provided are discussed in greater detail in [Appendix A](#). A positioning report prepared by CHANCE is presented in [Appendix D](#).

Exploratory Borings

The seven (7) exploratory borings completed during the CVX Gas Hydrates GoM JIP Program were targeted at the areas that exhibit a well-defined bottom-simulating reflector (BSR) identified from seismic data. Two areas, Atwater Valley 13/14 and Keathley Canyon 151, were identified by the pre-cruise analysis of the 3-D seismic data as having the potential to bear significant amounts of gas hydrate saturated sediments at depths accessible to the JIP program. The sub-surface coordinates, the measured water depths, and the termination depths of the borings are tabulated in Tables [I-1](#) and [I-2](#) for LWD/MWD borings and soil coring borings, respectively.

[Table I-1](#) on the next page presents the coordinates for the three (3) LWD/MWD borings drilled using the Schlumberger LWD/MWD bottom hole assembly. Sediment core samples were not obtained in any of the LWD/MWD borings. The sub-surface coordinates were determined by fixing the position of an acoustic beacon mounted on the ROV. Any horizontal offset to the actual drill string position was neglected.

Table I-1 – LWD/MWD Boring Coordinates and Water Depth Measurements

Boring <i>Termination Depth</i>	Area Block <i>Coordinate System</i>	Coordinates ⁽²⁾		Water Depth [ft]		
		Proposed	Final Sub-Surface	Pipe Tally ⁽¹⁾ <i>Date / Time</i>	Acoustic Beacon ⁽³⁾	CTD ⁽⁴⁾
		Easting [ft] ----- Northing [ft]	Easting [ft] ----- Northing [ft]			
AT13#1 <i>246.6m (809-ft)</i>	Atwater Valley Block 13 <i>UTM Zone 16</i>	901,438.19	901,439.08	1,290.5m (4,234-ft) <i>(2110hrs – April 19, 2005)</i>	1,280.2m (4,200-ft)	1,299.1m (4,262-ft)
		10,148,521.86	10,148,522.91			
AT14#1 <i>286.5m (940-ft)</i>	Atwater Valley Block 14 <i>UTM Zone 16</i>	904,181.44	904,202.80	1,300.3m (4,266-ft) <i>(0115hrs – April 22, 2005)</i>	1,298.8m (4,261-ft)	N/A
		10,145,035.55	10,145,043.93			
KC151#2 <i>459.3m (1,507-ft)</i>	Keathley Canyon Block 151 <i>UTM Zone 15</i>	1,644,827.03	1,644,815.89	1,321.9m (4,337-ft) <i>(0635hrs – May 8, 2005)</i>	1,320.4m (4,332-ft)	N/A
		9,733,112.41	9,733,119.97			

(1) Dates and Times of measurements indicated below each depth measurement.
(2) Acoustic Beacon mounted on the ROV. A vertical offset of approximately 3-ft is accounted for.
(3) Acoustic Beacon mounted on the Seabed Frame (SBF). A vertical offset of approximately 8-ft is accounted for.
(4) CTD deployed using the Halibut basket. A vertical offset of approximately 6-ft is not accounted for.

Table I-2 below presents to the soil boring locations where sediment cores were obtained and recovered to deck. The sub-surface coordinates were determined by fixing the position of an acoustic beacon mounted on the seabed frame that was used to provide reaction during the sampling operations. A horizontal offset to the actual drill string position was neglected.

Table I-2 – Soil Boring Coordinates and Water Depth Measurements

Boring <i>Termination Depth</i>	Area Block <i>Coordinate System</i>	Coordinates ⁽³⁾		Water Depth [ft]		
		Proposed	Final Sub-Surface	Pipe Tally ⁽¹⁾ <i>Date / Time</i>	Acoustic Beacon ⁽²⁾	CTD ⁽⁴⁾
		Easting [ft] ----- Northing [ft]	Easting [ft] ----- Northing [ft]			
AT13#2 <i>199.9m (656-ft)</i>	Atwater Valley Block 13 <i>UTM Zone 16</i>	901,438.19	901,464.60	1,291.1m (4,236-ft) <i>(2110hrs – April 26, 2005)</i>	1,292.4m 4,240-ft	1,288.3m (4,227-ft)
		10,148,521.86	10,148,553.60			
ATM1 <i>26.8m (88-ft)</i>	Atwater Valley Block 14 <i>UTM Zone 16</i>	904,551.77	904,552.60	1,296.0m (4,252-ft) <i>(1945hrs – May 3, 2005)</i>	1,294.8m (4,248-ft)	N/A
		10,144,646.77	10,144,643.27			
ATM4 <i>28.9m (95-ft)</i>	Atwater Valley Block 14 <i>UTM Zone 16</i>	904,470.29	904,479.25	1,295.4m (4,250-ft) <i>(1630hrs – May 4, 2005)</i>	1,293.0m (4,242-ft)	N/A
		10,144,646.25	10,144,645.33			
KC151#3 <i>438.9m (1,440-ft)</i>	Keathley Canyon Block 151 <i>UTM Zone 15</i>	1,644,827.03	1,644,769.01	1,322.5m (4,339-ft) <i>(1400hrs – May 11, 2005)</i>	1,320.7m (4,333-ft)	1,319.0m (4,328-ft)
		9,733,112.41	9,733,120.95			

(1) Dates and Times of measurements indicated below each depth measurement.
(2) Acoustic Beacon mounted on the ROV. A vertical offset of approximately 3-ft is accounted for.
(3) Acoustic Beacon mounted on the Seabed Frame (SBF). A vertical offset of approximately 8-ft is accounted for.
(4) CTD deployed using the Halibut basket. A vertical offset of approximately 6-ft is not accounted for.

Drilling Equipment and Procedures

The exploratory borings were drilled using a motion compensated, Dreco-built, hydraulic top drive power swivel mounted in an 85-ft derrick. The drill string was made up from a combination of 7.00-in.-OD, 4.00-in.-ID drill collars, 5.50-in.-OD, 4.125-in.-ID steel drill pipes and 5.50-in.-OD, 4.125-in.-ID aluminum drill pipes. For the LWD/MWD borings (AT13#1, AT14#1, KC151#2), the bottom 102.90 m (337.6-ft) of the drill string was made up from a combination of the BHA (consisting of the drill bit, and Schlumberger

GeoVision Resistivity, EcoScope, TeleScope, proVision, and Azimuthal Density Tools, and crossover) and four (4) drill collars, the Schlumberger JAR, followed by another eight (8) drill collars. For the remaining four (4) soil sampling borings (AT13#2, ATM1, ATM4, KC151#3), the bottom 97.12 m (318.6-ft) of the drill string was made up from a combination of the drill bit, a bit sub, one long and one short seal bore collar, the landing sub, driver sub 'Holland', driver sub 'Houston', and an additional nineteen (19) drill collars. The remainder of the drill string was made up of sixty-two (62) steel and aluminum drill pipes.

The borings were advanced by conventional open-hole wet rotary techniques, with drilling returns expelled at the seafloor. During the drilling operations, seawater, fresh-water gel and weighted drilling mud were used to help remove drill cuttings. Expansive and gassy formations were controlled by using XCD polymer, an additive to the weighted mud used during the drilling operations. More detailed descriptions of the drilling equipment and procedures used to complete the soil borings are presented in Appendix A.

Sediment Coring

The objective of the JIP drilling program was aimed at the recovery of hydrate-bearing sediment for geotechnical, geochemical, geological and microbiological testing and analyses. Four (4) different coring systems, each with their own area of application, were used during the investigation to provide fast, reliable, and continuous recovery of sediment material downhole. The coring systems can be categorized in two groups: Non-pressurized and Pressurized Coring Systems. All soil samples were obtained through the 4.125-in.-ID drill string. Tables I-3A through I-3D summarize the deployment and recovery of cores in each of the four (4) sampling borings.

Table I-3A – AT13#2: Core Deployment and Recovery

Core ID	Deployment Depth		Sampler	Retained Pressure		Curatorial Length		Comments
	[m]	[ft]		[MPa]	[psi]	[m]	[ft]	
01H	0.00	0.0	FHPC			7.00	23.0	
02H	7.01	23.0	FHPC			8.77	28.8	Liner cracked
03P	15.54	51.0	FPC	0.0	0.0	1.40	4.6	No physical integrity retained
04H	18.29	60.0	FHPC			8.71	28.6	Broken Liner
05R	27.13	89.0	HRC	0.0	0.0	0.93	3.1	Liner not fully recovered into autoclave
06H	28.65	94.0	FHPC			9.42	30.9	
07P	37.80	124.0	FPC	15.0	2,175	0.54	1.8	
08H	39.62	130.0	FHPC			8.54	28.0	
09H	118.26	388.0	FHPC			7.21	23.7	Broken Liner
10R	126.19	414.0	HRC	0.0	0.0	No Recovery		
11H	126.80	416.0	FHPC			6.01	19.7	
12P	134.11	440.0	FPC	0.0	0.0	1.19	3.9	FPC lost during recovery
13H	141.12	463.0	FHPC			8.76	28.7	APCT deployment
14H	150.27	493.0	FHPC			8.91	29.2	Top 7.64m of core not recovered
15PI	158.50	520.0	Piezo					Unsuccessful

Table I-3B – ATM1: Core Deployment and Recovery

Core ID	Deployment Depth		Sampler	Retained Pressure		Curatorial Length		Comments
	[m]	[ft]		[MPa]	[psi]	[m]	[ft]	
1H	0.0	0.0	FHPC			2.26	7.4	Recovered material w/ soupy
2H	7.32	24.0	FHPC			9.07	29.8	
3P	15.85	52.0	FPC	No Recovery				
4R	17.37	57.0	HRC	No Recovery				
5H	18.90	62.0	FHPC			8.05	26.4	
6P	26.82	88.0	FPC	No Recovery !				

Table I-3C – ATM4: Core Deployment and Recovery

Core ID	Deployment Depth		Sampler	Retained Pressure		Curatorial Length		Comments
	[m]	[ft]		[MPa]	[psi]	[m]	[ft]	
1H	0.0	0.0	FHPC			3.81	12.5	
2H	7.92	26.0	FHPC			6.22	20.4	
3H	17.37	57.0	FHPC			8.95	29.4	
4R	25.30	83.0	HRC	No Recovery				
5P	26.82	88.0	FPC	14.2	2,060	0.52	1.7	
6R	28.96	95.0	HRC	No Recovery				

The **Fugro Hydraulic Piston Corer (FHPC)** was selected as the primary tool for the investigation. Soil samples were recovered in 2.8-in.-OD, 2.6-in.-ID clear Cellulose Acetate Butyrate (CAB) liners when using the FHPC. For this investigation, the FHPC was configured with a 30-ft barrel and 25-ft piston (stroke) to accommodate the recovery of highly expansive materials with the objective of minimizing loss of sample material due to self-extrusion. Soil samples were obtained by increasing the mud pressure inside the drill string above a pre-set threshold level, which allowed 1, 2, or 3 shear pins to fail and fire the sampler into the soil formation.

A total of nine (9) cores were recovered using the FHPC in each of the Borings AT13#2 and KC151#3, and three (3) cores in each of the Borings ATM1 and ATM4, with the curatorial length ranging from 2.25 m (7.4-ft) to 9.42 m (30.9-ft). Note that the curatorial length does not represent the actual length of sample material recovered using the FHPC, but includes voids and cracks caused by sample expansion. Samples obtained using the FHPC are indicated by 'FHPC' on the Log of Boring and Test Results presented on Plates I-2 and I-3. More detailed descriptions of the coring equipment and procedures used to complete the soil borings are presented in [Appendix A](#).

In formations where the FHPC yielded limited or no-recovery due to the formation stiffness (i.e., hard clays) or the presence of granular material in the stratigraphy, the Fugro Corer (FC) was selected as the tool of choice to obtain non-pressurized samples. The FC was configured with a 10- or 15-ft long liner housed inside a core barrel that was pushed into the soil formation by increasing the mud-pressure inside the drill string. Once the formation resistance exceeded a threshold value, a percussion mechanism driven by the mud-pressure was activated and drove the coring barrel past the drill bit.

A total of twelve (12) cores were obtained from Boring KC151#3 using the FC, with the maximum curatorial length measured at 4.10 m (13.5-ft). One of the deployments (Core 16C) was unsuccessful and produced no recovery. Samples obtained using the FC are indicated by 'FC' on the Log of Boring and Test Results presented on [Plate I-3](#). More detailed descriptions of the coring equipment and procedures used to complete the sampling borings are presented in [Appendix A](#).

Table I-3D – KC151#3: Core Deployment and Recovery

Core ID	Deployment Depth		Sampler	Retained Pressure		Curatorial Length		Comments
	[m]	[ft]		[MPa]	[psi]	[m]	[ft]	
01H	0.00	0.0	FHPC			7.13	23.4	
02H	9.45	31.0	FHPC			7.70	25.3	Rapid self-extrusion
03H	18.59	61.0	FHPC			7.86	25.8	Rapid self-extrusion
04H	28.04	92.0	FHPC			7.86	25.8	Rapid self-extrusion
05H	37.19	122.0	FHPC			7.87	25.8	Rapid self-extrusion
06C	99.97	328.0	FC			3.49	11.5	Rapid self-extrusion
07C	210.01	689.0	FC			0.88	2.9	
08C	214.88	705.0	FC			4.10	13.5	
09R	220.98	725.0	HRC	No Recovery				
10C	223.11	732.0	FC			3.50	11.5	
11P	227.08	745.0	FPC	14.0	2,031	0.88	2.9	
12C	230.12	755.0	FC			2.09	6.9	
13R	235.92	774.0	HRC	10.0	1,450	1.00	3.3	
14C	242.01	794.0	FC			3.30	10.8	
15C	252.07	827.0	FC			3.50	11.5	
16C	256.03	840.0	FC			No Recovery !		Hammering mechanism malfunction
17H	256.03	840.0	FHPC			5.66	18.6	Self-extrusion
18P	265.18	870.0	FPC	YES		0.59	1.9	Cracked sample liner
19H	274.62	901.0	FHPC			7.85	25.8	Rapid self-extrusion
20H	292.91	961.0	FHPC			7.80	25.6	
21H	311.51	1,022.0	FHPC			2.25	7.4	
22C	330.40	1,084.0	FC			2.99	9.8	
23C	349.91	1,148.0	FC			0.40	1.3	
24C	369.42	1,212.0	FC			2.20	7.2	
25C	378.56	1,242.0	FC			1.00	3.3	
26R	383.13	1,257.0	HRC	14.0	2,031	0.51	1.7	
27P	384.96	1,263.0	FPC	No Recovery				Core stuck during recovery
28R	387.10	1,270.0	HRC	No Recovery				
29R	389.53	1,278.0	HRC	0.0	0.0	0.25	0.8	

The **Fugro Pressure Corer (FPC)** and the **Hyace Rotary Corer (HRC)** were used to recover cores up to 1.0 m (3.3-ft) in length while retaining in situ pressures of up to 25 MPa (3,625 psi). Both systems are currently in the developmental stage and were made available to the CVX GoM Gas Hydrates JIP Drilling Program through Fugro's involvement. The systems were developed as part of the European HYACE (Hydrate Autoclave Coring Equipment) project and both incorporate an autoclave to seal the core tube at ambient in situ pressure and thermal conditions.

The driving mechanism and characteristics of the FPC corresponded to that of the Fugro Corer (FC). Until the tool experienced a threshold resistance from the coring material during penetration, the FPC, just like the FC, penetrated the formation like a hydraulically driven push-sampler. Once the formation resistance exceeded the threshold level (2.75 MPa or 400 psi mud pressure), the pressure driven percussion hammer activated and drove the coring system past the bit into the formation. The tool was extracted from the soil formation using the drill string. The core was then retracted inside the autoclave by

pulling on the wireline. When the core was fully retracted inside the autoclave, a flapper valve mechanism sealed the retained pressure inside the autoclave.

A total of nine (9) deployments were undertaken using the FPC. Three (3) were performed in each of the Borings AT13#2 and KC151#3, two (2) in Boring ATM1, and one (1) in Boring ATM4. The maximum curatorial length of material retained inside the core liner was measured at 1.40 m (4.6-ft). [Table I-3](#) presents the individual core recovery and pressures upon recovery for each of the FPC and HRC deployments. More detailed descriptions of the coring equipment and procedures used to complete the sampling borings are presented in [Appendix A](#). Samples obtained using the FPC are indicated by 'FPC' on the Log of Boring and Test Results presented on Plates [I-2](#) and [I-3](#)

The HRC system developed by the Technical University Clausthal in Germany, utilizes a water-driven rotary motor (Inverse Moineau Motor) that is activated by mud-pressure inside the drill string. Similar to the FC, the HRC was intended to provide contingency in coring operations for non-pressurized coring intervals. The HRC system was intended to provide contingency in pressurized coring operations, once the FPC system reaches its limitations. The rotary coring mechanism can be deployed and successfully utilized in a wider range of soil conditions. Constant mud pressure and flow rate inside the drill string provided the energy during penetration of the system. The tool was extracted from the soil formation using the drill string. The core was then retracted inside the autoclave by pulling on the wireline. When the core is fully retracted inside the autoclave, a flapper valve mechanism sealed the retained pressure inside the autoclave.

A total of ten (10) deployments were undertaken during the investigation. Two (2) of the deployments were performed in AT13#2, five (5) in KC151#3, one (1) in ATM1, and two (2) in ATM4. More detailed descriptions of the coring equipment and procedures used to complete the soil borings are presented in [Appendix A](#). Samples obtained using the HRC are indicated by 'HRC' on the Log of Boring and Test Results presented on Plates [I-2](#) and [I-3](#)

ROV Surveys and ROV Push Cores

A Triton XL ROV operated by Canyon Offshore, Inc. provided visual inspections of the seafloor and monitoring of the well sites and drill string – seafloor interface during subsurface operations at each boring location. Shallow gas / water flows were identified during operations on May 10, 2005 during drilling of the KC151#2 LWD/MWD boring, and on May 18, 2005 during drilling of Boring KC151#3. Each of the flows was contained and shut-off prior to abandoning the boring sites.

The ROV was also used to obtain near seafloor soil samples using Fugro's ROV Push Sampler. Standard liner samplers with either 2.00-in.-OD, 1.875-in.-ID, or 2.50-in.-OD, 2.125-in.-ID liners, and clear plastic liners, 2.875-in.-OD, 2.635-in.-ID, were fitted with an ROV handle bar or T-Bar handle. The push core samplers were housed inside the holsters mounted on the Halibut basket, which was then lowered to the mudline. The ROV used one of its arms to take one of the samplers at a time and manually push the sampler into the seafloor. The sampler was placed back onto the Halibut basket inside the designated holster upon extraction of the sampler from the seafloor.

A total of twenty (20) ROV push samples were attempted in the near proximity of the exploratory borings in AT13, AT14 and KC151. Twelve (12) deployments were successful and retained sediments of the top 0.13 m (0.4-ft) to 0.81 m (2.7-ft) penetration. Two (2) cores, designated PC#2 and PC#7 from Atwater Valley Area, Block 14, and PC#2 from Keathley Canyon Area, Block 151, were processed and tested onboard the vessel by Fugro's engineers and soil technicians. The remainder of the samples were dedicated for geo- and biochemical laboratory testing by the onboard scientific party. [Table I-4](#) on the next page presents a summary of the ROV push core recovery. Logs of ROV Push Core and Test Results for PC#2 and PC#7 from AT14, and PC#2 from KC151, are presented on Plates [I-4](#) through [I-6](#) respectively.

Advanced Piston Corer Temperature Tool

The Advanced Piston Corer Temperature (APCT) tool is a temperature data logger that collects temperature data in a deep-sea borehole (IOPD, 2004). The tool was originally designed and fitted for deployment using IODP's Advanced Piston Corer (APC). A specially fabricated cutting shoe was designed and used to accommodate the APCT, which was mounted on a cylindrical metal frame and attached to the FHPC during selected deployments. By mounting the APCT to the FHPC cutting shoe, the formation temperature and universal time could be obtained concurrently with retrieving a core sample with only minimal time delay. Upon recovery of the FHPC to deck, the APCT is recovered from the cutting shoe and connected to a PC to download and process the recorded data. Plots of recorded data and their respective designation are presented on Plates I-8 through I-11.

Water Depth Measurements

Water depth measurements were performed at each boring location by observing the drill string touching the seafloor using the ROV, and then calculating water depth from the measured pipe tally. The seafloor location of each measurement was determined with the LUSBL system from an acoustic beacon mounted on the ROV and/or the seabed frame (SBF). The coordinates, time and depth associated with each water depth measurement are presented in Table I-1 for the LWD/MWD borings, and Table I-2 for soil borings.

Subsequent water depth measurements were obtained using the acoustic beacon mounted either on the ROV or the SBF. The water depths presented include a correction for the offset of the beacon mounted on either the ROV or the SBF with reference to the mudline.

A conductivity, temperature and density (CTD) oceanographic device (Seabird SBE 19 Seacat Profiler) was also used to obtain supplementary water depths at the AT13#1, AT13#2, and KC151#3 locations. The water depths presented are based on the readings recorded by the CTD profiler mounted on the Halibut basket and have been corrected for the offset position of the CTD profiler with reference to the mudline. Plates I-12 through I-14 present temperature and salinity readings over depth below sea surface recorded using the CTD profiler at location AT13#1, AT13#2, and KC151#3, respectively.

The water depth measuring techniques are further described in Appendix A. The water depth measurements are intended for the purpose of the exploration investigation only, and are not corrected for tidal or other variations. If utilized for other purposes, the water depth measurements should be adjusted to account for meteorological tide and datum corrections.

Table I-4A –Push Core Deployment and Recovery (Atwater Valley, Blocks 13 and 14)

Core ID	Area	Curatorial Length		Comments
		[m]	[ft]	
JIP AT13, PC1	Atwater Valley, Block 13	---	---	No Recovery – Liner lost during extraction from formation
JIP AT13, PC2		0.72	2.6	
JIP AT13, PC3		0.42	1.4	
JIP AT13, PC4		---	---	Core not deployed
JIP AT13, PC5		0.58	1.9	Used for physical properties w/ Fugro
JIP AT14, PC1	Atwater Valley, Block 14	0.35	1.1	
JIP AT14, PC2		0.69	2.3	
JIP AT14, PC3		---	---	No Recovery
JIP AT14, PC4		---	---	No Recovery
JIP AT14, PC5		0.13	0.4	No Recovery
JIP AT14, PC6		0.31	1.0	
JIP AT14, PC7		0.35	1.1	Used for physical properties w/ Fugro
JIP AT14, PC8		0.20	0.7	
JIP AT14, PC9		---	---	No Recovery
JIP AT14, PC10		0.34	1.1	
JIP AT14, PC8		0.20	0.7	
JIP AT14, PC9		---	---	No Recovery
JIP AT14, PC10		0.34	1.1	

Table I-4B –Push Core Deployment and Recovery (Keathley Canyon, Block 151)

Core ID	Area	Curatorial Length		Comments
		[m]	[ft]	
JIP KC151, PC1	Keathley Canyon, Block 151	0.43	1.4	
JIP KC151, PC2		0.81	2.7	

Water Sampling

Water samples were obtained at each of the ROV push core locations, in the immediate vicinity of the AT13, AT14, and KC151 boring locations. Niskin bottle water samplers were mounted on the Halibut basket, which was then deployed to the mudline. The ROV operator at the request of the onboard scientific staff triggered the Niskin bottles, and the water samples were retrieved and stored in plastic containers. Water samples were directly given to the scientific staff onboard the vessel for further analysis.

LABORATORY INVESTIGATION

The laboratory investigation for this study comprised both standard and advanced testing programs. Both programs were designed to evaluate pertinent index and engineering properties of the soils encountered. A total of ten (10) samples from Boring AT13#2 and eight (8) samples from Boring KC151#3 were provided to FMMG for laboratory testing in the field. An additional thirteen (13) samples from Boring KC151#3 were sent to Fugro upon fieldwork completion, and were used primarily for the advanced laboratory testing programs. [Table I-5A](#) (below) and [I-5B](#) (next page) present a list of the samples from Borings AT13#2 and KC151#3, respectively, that were made available for the geotechnical laboratory programs.

Table I-5A – Summary of Samples used for Geotechnical Laboratory Program (AT13#2)

Sample ID ⁽¹⁾	Tool	Depth: Top - Bottom		Comments
		[mbsf]	[ft BML]	
1H-3	FHPC	2.00 - 2.30	6.6 - 7.6	
1H-7	FHPC	6.00 - 6.30	19.7 - 20.7	
2H-2	FHPC	8.00 - 8.30	26.2 - 27.2	
2H-8	FHPC	14.00 - 14.30	45.9 - 46.9	
4H-2	FHPC	19.30 - 19.60	63.3 - 64.3	
4H-6	FHPC	23.30 - 23.60	76.4 - 77.4	
6H-1	FHPC	29.25 - 29.55	96.0 - 97.0	
6H-4	FHPC	32.17 - 32.47	105.5 - 106.5	
8H-2	FHPC	41.16 - 41.46	135.0 - 136.0	
8H-9	FHPC	47.86 - 48.16	157.0 - 158.0	
Sample nomenclature: <Core No.><Type of Core> - <Section No.> H: Fugro Hydraulic Piston Corer (FHPC) Sample C: Fugro Corer (FC) Sample P: Fugro Pressure Corer (FPC) Sample R: Hyace Rotary Corer (HRC) Sample				

Conventional Laboratory Testing

The standard laboratory testing program was conducted in two phases: (1) offshore in a field laboratory onboard the MSV *Uncle John* as the field activities progressed, and (2) onshore in Fugro's Houston laboratory. After an initial review of the field test results and of the samples available for the subsequent onshore Conventional and Specialized Laboratory Program, FMMG issued a request for the provision of additional liner samples to conduct the laboratory program as outlined by Mr. Brandon Dugan, Rice University. Results and interpretation of data obtained from the conventional and advanced laboratory testing program are further discussed in Section II of this report. The following paragraphs pertain to a general discussion of tests conducted in both phases of the laboratory testing program.

Offshore Testing. Several types of shear strength tests were performed in the field on selected FHPC, FC and HRC soil samples recovered from the borings. FHPC and FC samples were made available upon direction of Brandon Dugan of Rice University, and usually consisted of 30cm (1-ft) long samples, cut from one FC or FHPC section. Undisturbed miniature vane tests were performed on the samples, while the samples were still confined within the liner. After extrusion, unconsolidated-undrained (UU) triaxial compression tests were performed whenever possible. Additional shear strength estimates were performed using Torvane and Pocket Penetrometer devices. Miniature vane tests were also performed on selected cohesive samples that were remolded, in order to evaluate sample disturbance effects.

Natural moisture content determinations were performed on all samples. The unit weight of each sample was measured and a qualitative assessment of carbonate content was made using diluted hydrochloric acid (10% concentration). After testing, representative portions of each sample were sealed in airtight containers for shipment to our laboratory in Houston, Texas.

Table I-5B – Summary of Samples used for Geotechnical Laboratory Program (KC151#3)

Sample ID	Tool	Depth: Top - Bottom		Comments
		[mbsf]	[ft BML]	
01H-3	FHPC	2.50 - 2.80	8.2 - 9.2	
01H-6	FHPC	5.50 - 5.80	18.0 - 19.0	
02H-4	FHPC	12.95 - 13.25	42.5 - 43.5	
02H-6	FHPC	14.95 - 15.25	49.0 - 50.0	
03H-7	FHPC	24.59 - 24.75	80.7 - 81.2	
04H-2	FHPC	29.54 - 29.79	96.9 - 97.7	
05H-6	FHPC	42.77 - 42.95	140.3 - 140.9	
05H-6	FHPC	42.19 - 42.39	138.4 - 139.1	
05H-7	FHPC	43.99 - 44.19	144.3 - 145	
06C-1	FC	100.62 - 100.82	330.1 - 330.8	
07C-1	FC	210.01 - 210.21	689.0 - 689.7	
08C-2	FC	216.43 - 216.63	710.1 - 710.7	
10C-2	FC	224.11 - 224.31	735.3 - 735.9	
12C-1	FC	230.77 - 230.97	757.1 - 757.8	
14C-2	FC	243.56 - 243.76	799.1 - 799.7	
17H-3	FHPC	258.83 - 259.03	849.2 - 849.8	
19H-4	FHPC	278.38 - 278.62	913.3 - 914.1	
20H-4	FHPC	295.91 - 296.21	970.8 - 971.8	
21H-2	FHPC	313.00 - 313.21	1,026.9 - 1,027.6	
22C-shoe	FC	333.39 - 333.69	1,093.8 - 1,094.8	
22C-shoe	FC	383.15 - 383.25	1,257.1 - 1,257.4	
23C-shoe	FC	350.31 - 350.61	1,149.3 - 1,150.3	
24C-2	FC	370.42 - 370.62	1,215.3 - 1,215.9	
24C-shoe	FC	370.62 - 370.92	1,215.9 - 1,216.9	
25C-shoe	FC	379.56 - 379.86	1,245.3 - 1,246.3	
26R	HRC	385.15 - 383.25	1,257.1 - 1,257.4	
Sample nomenclature: <Core No.><Type of Core> - <Section No.> H: Fugro Hydraulic Piston Corer (FHPC) Sample C: Fugro Corer (FC) Sample P: Fugro Pressure Corer (FPC) Sample R: Hyace Rotary Corer (HRC) Sample				

Most of the samples showed significant degree of expansion and were not suitable for any UU or more advanced strength testing. Testing performed on those samples was limited to strength estimates and determination of index properties.

Detailed descriptions of test procedures are presented in [Appendix B](#). All tests were performed in general accordance with ASTM Standards (2004).

Onshore Testing. After reviewing the field tests results, a program of onshore laboratory testing was formulated in accordance with the testing schedule outlined by Mr. Brandon Dugan of Rice University,

to supplement and verify field information and to further aid the classification and strength evaluation of the soils. Atterberg limit determinations and additional water content tests were performed on soil samples from each section made available to FMMG. Also, additional miniature vane shear tests, remolded and undisturbed, were performed on selected soil samples.

All classification and strength test results performed offshore and onshore are presented graphically on the boring logs, Plates I-2 through I-3, and are tabulated in the Summaries of Test Results presented in Appendix B. Also included in Appendix B are the normalized stress-strain curves from the undisturbed UU triaxial compression tests.

Specialized Laboratory Testing

Advanced Static Laboratory Testing. The advanced laboratory testing program was determined by FMMG and corresponds to the testing schedule outlined by Mr. Brandon Dugan of Rice University. The advanced testing program was performed to: (1) evaluate the soil stress history at the sites AT13#2 and KC151#3, (2) obtain normalized shear strength properties of the soils, and (3) further evaluate the static undrained shear strength by applying the SHANSEP (Stress History and Normalized Soil Engineering Properties) approach.

The advanced static laboratory tests included:

- (1) Hydrometer analysis;
- (2) Specific gravity tests;
- (3) Controlled-rate-of-strain (CRS) one-dimensional consolidation tests;
- (4) K_0 -consolidated, undrained, strain-controlled, static direct simple shear (CK_0U' -DSS) tests;
- (5) K_0 -consolidated, triaxial extension (TPK₀-TE) tests; and
- (6) Hydraulic Conductivity (Permeability) Tests.

Sample Quality

Samples were obtained during the field investigation using one of the four (4) coring systems described in Section I. Both the FHPC and FC systems recover unpressurized cores, 71 mm (2.8-in.) in outer diameter, 66 mm (2.6-in.) in inner diameter, and up to 9.1 m (30-ft) and 4.6 m (15-ft) in length, respectively. The FPC and HRC both recover pressurized cores, 51 mm (2.00-in.) in diameter and up to 1.0 m (3.3-ft) in length. Based on field investigation, the sample quality was expected to vary significantly, with horizons indicating very high expansive characteristics yielding lower, sub-geotechnical grade sample quality. X-ray photographs (presented in Appendix C) were taken of selected liner-enclosed FHPC and FC samples from Boring KC151#3, and were reviewed to determine the apparent quality of soil available for laboratory testing.

The results of the x-ray radiography show that, generally, the samples from Boring KC151#3 have undergone significant disturbance and/or expansion during sampling and transportation. Large voids caused by gas expansion during recovery of the sample to the sea surface are visible, in particular for the FHPC samples. FC samples indicate a somewhat more homogenous soil structure and show only little expansion characteristics (i.e., expansion cracks). However, FC samples also show less soil structure (i.e., bedding planes) than the FHPC samples which indicates that difference in sampling technique for the FC helps control expansion, but might remold the soil structure. Sample quality is further discussed in Section II of this report on the basis of available laboratory data.

GENERAL SOIL CONDITIONS

The soil conditions encountered at the AT13#2 and KC151#3 well locations vary from very soft clay at the seafloor to hard clay at final penetration depths of 199.9 mbsf (656 ft) and 438.9 mbsf (1,507 ft), respectively. Granular sediment material was not found in any of the cores recovered to deck. However, drilling parameters indicated the presence of granular material and was confirmed during drilling operations as described in the following paragraphs. Detailed soil descriptions that include textural variations of those samples available to FMMG are noted on the boring logs. A key to the terms and symbols used on the boring logs is presented on [Plate I-7](#).

Borings AT13#2 and KC151#3 were drilled in close proximity to the LWD/MWD borings AT13#1 in Atwater Valley Area, Block 13, and KC151#2 in Keathley Canyon Area, Block 151, respectively. The boring locations were selected by the JIP scientific crew based on the review of the geophysical data.

A shallow gas flow was observed by the ROV while pulling pipe after completion of the LWD/MWD boring at KC151#2 with the bit at approximately 60.7 mbsf (199 ft) below mudline. The shallow flow was monitored and contained prior to departure from the location. Over-pressured shallow gas/water flows are commonly associated with sand strata overlain by low-permeable clay strata.

An over-pressurized sand strata was encountered during drilling operations at KC151#3 at a penetration of approximately 104.9 mbsf (344 ft) and resulted in the FPC tool getting stuck in the BHA due to back-flow of sand into the BHA.

SECTION I
ILLUSTRATIONS

Checked By:
Approved By:

Date:
Date:

Drawn By:

Date:

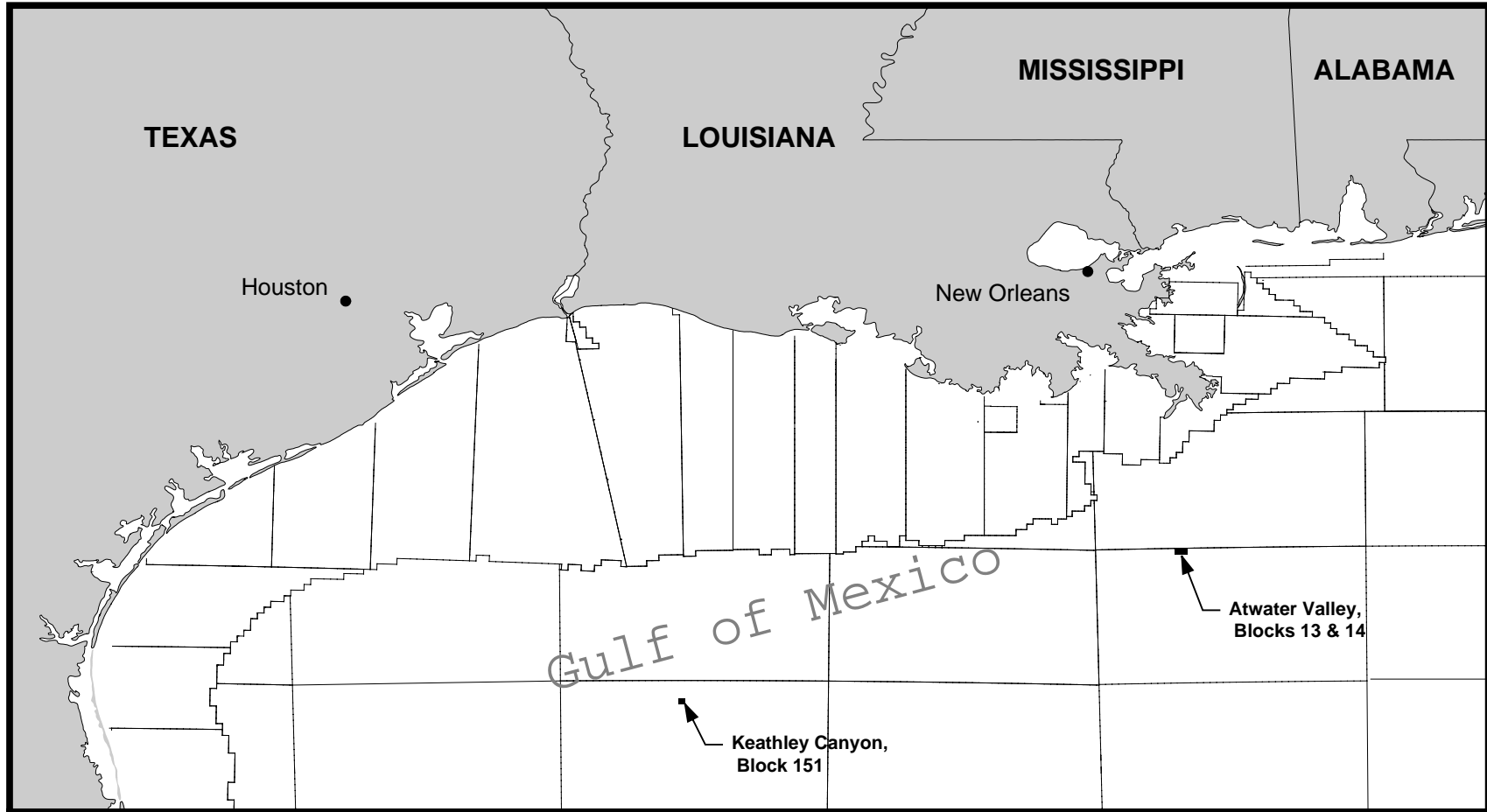

GENERAL LOCATION MAP

CVX GULF OF MEXICO GAS HYDRATES JIP
Blocks 13 and 14, Atwater Valley Area
Block 151, Keathley Canyon Area

Report No. 0201-5081 (Section 1)

PENETRATION BELOW SEAFLOOR, [m]

PENETRATION BELOW SEAFLOOR, [m]

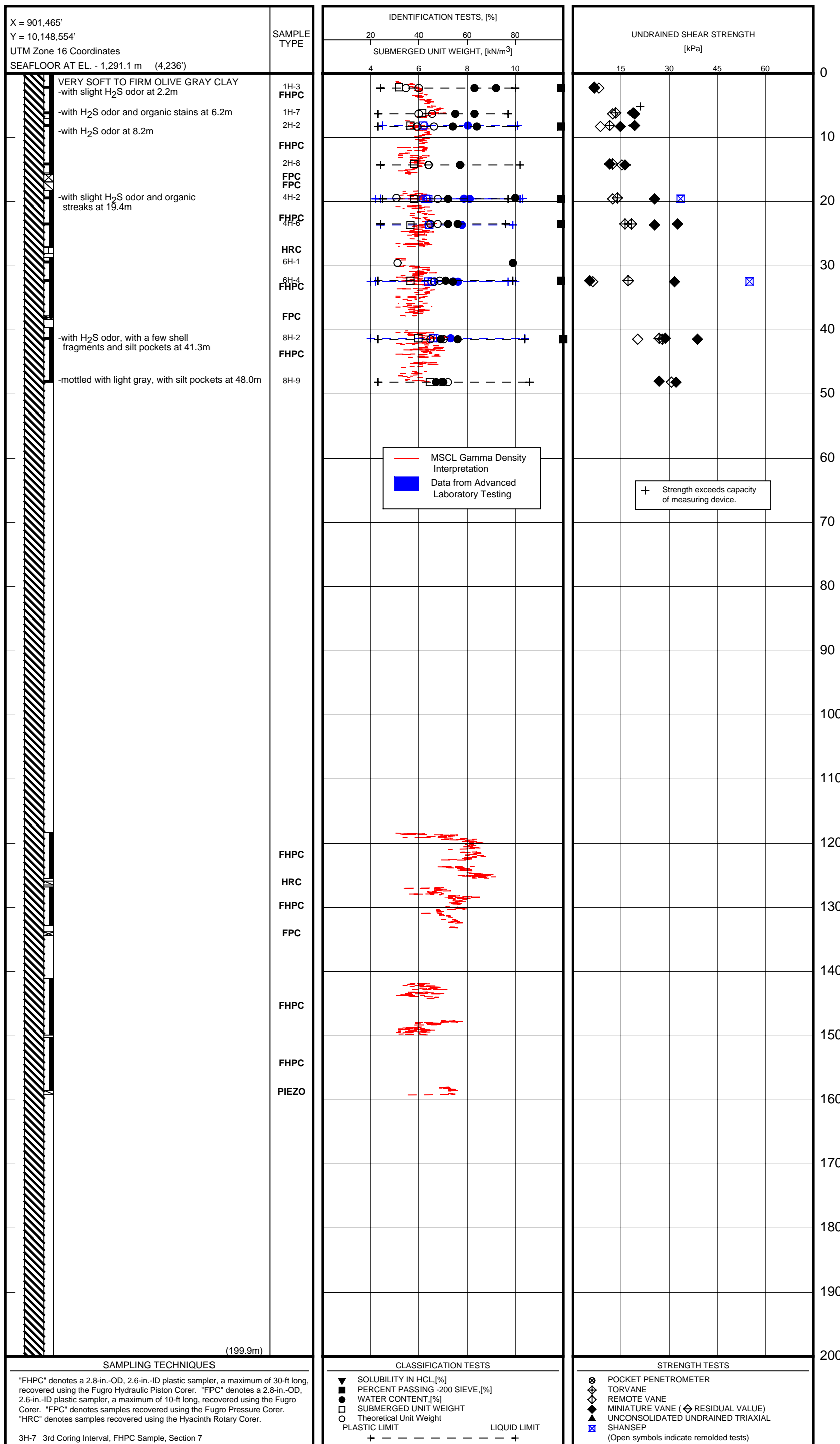

LOG OF BORING AND TEST RESULTS

Boring AT13#2, OCS-G-24203
 Block 13, Atwater Valley Area, Gulf of Mexico

PLATE I-2a



Report No. 0201-5081 (Section 1)

PENETRATION BELOW SEAFLOOR, [m]

PENETRATION BELOW SEAFLOOR, [m]

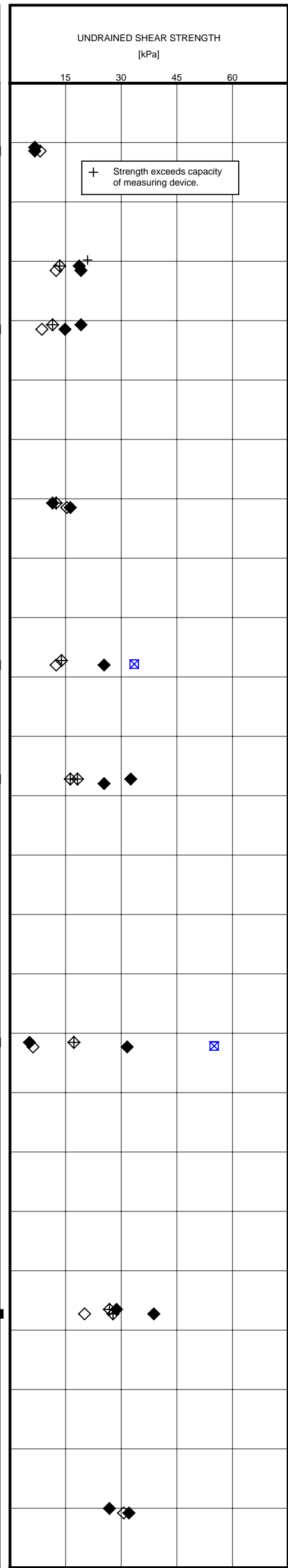
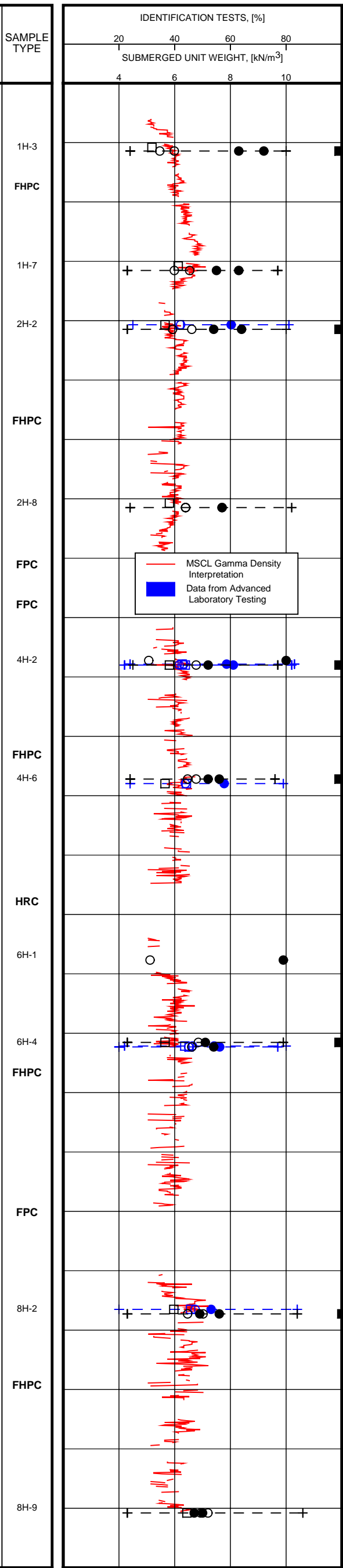
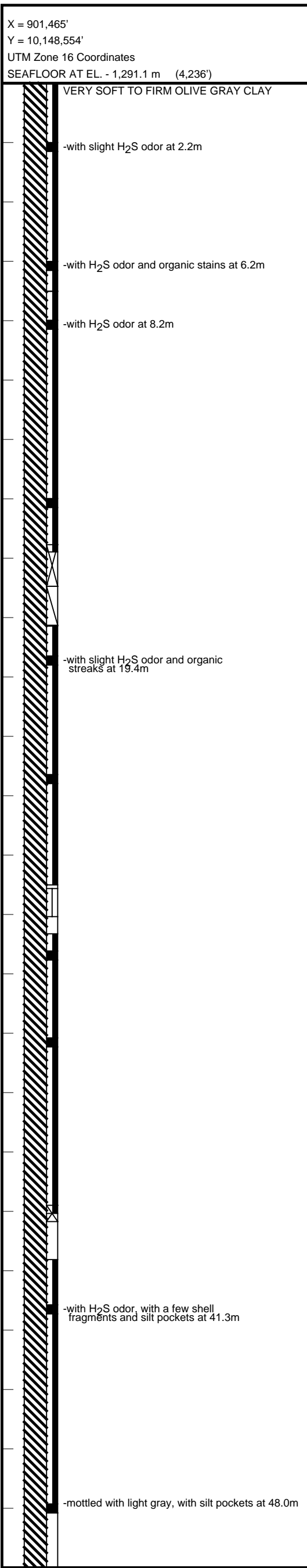

SAMPLING TECHNIQUES

"FHPC" denotes a 2.8-in.-OD, 2.6-in.-ID plastic sampler, a maximum of 30-ft long, recovered using the Fugro Hydraulic Piston Corer. "FPC" denotes a 2.8-in.-OD, 2.6-in.-ID plastic sampler, a maximum of 10-ft long, recovered using the Fugro Pressure Corer. "HRC" denotes samples recovered using the Hyacinth Rotary Corer.

3H-7 3rd Coring Interval, FHPC Sample, Section 7

CLASSIFICATION TESTS

▼ SOLUBILITY IN HCL, [%]
 ■ PERCENT PASSING -200 SIEVE, [%]
 ● WATER CONTENT, [%]
 ○ SUBMERGED UNIT WEIGHT
 □ Theoretical Unit Weight
 PLASTIC LIMIT LIQUID LIMIT

STRENGTH TESTS

⊗ POCKET PENETROMETER
 ◆ TORVANE
 ◇ REMOTE VANE
 ◆ MINIATURE VANE (◇ RESIDUAL VALUE)
 ▲ UNCONSOLIDATED UNDRAINED TRIAXIAL
 ⊠ SHANSEP
 (Open symbols indicate remolded tests)

LOG OF BORING AND TEST RESULTS

Boring AT13#2, OCS-G-24203
 Block 13, Atwater Valley Area, Gulf of Mexico

PLATE I-2b



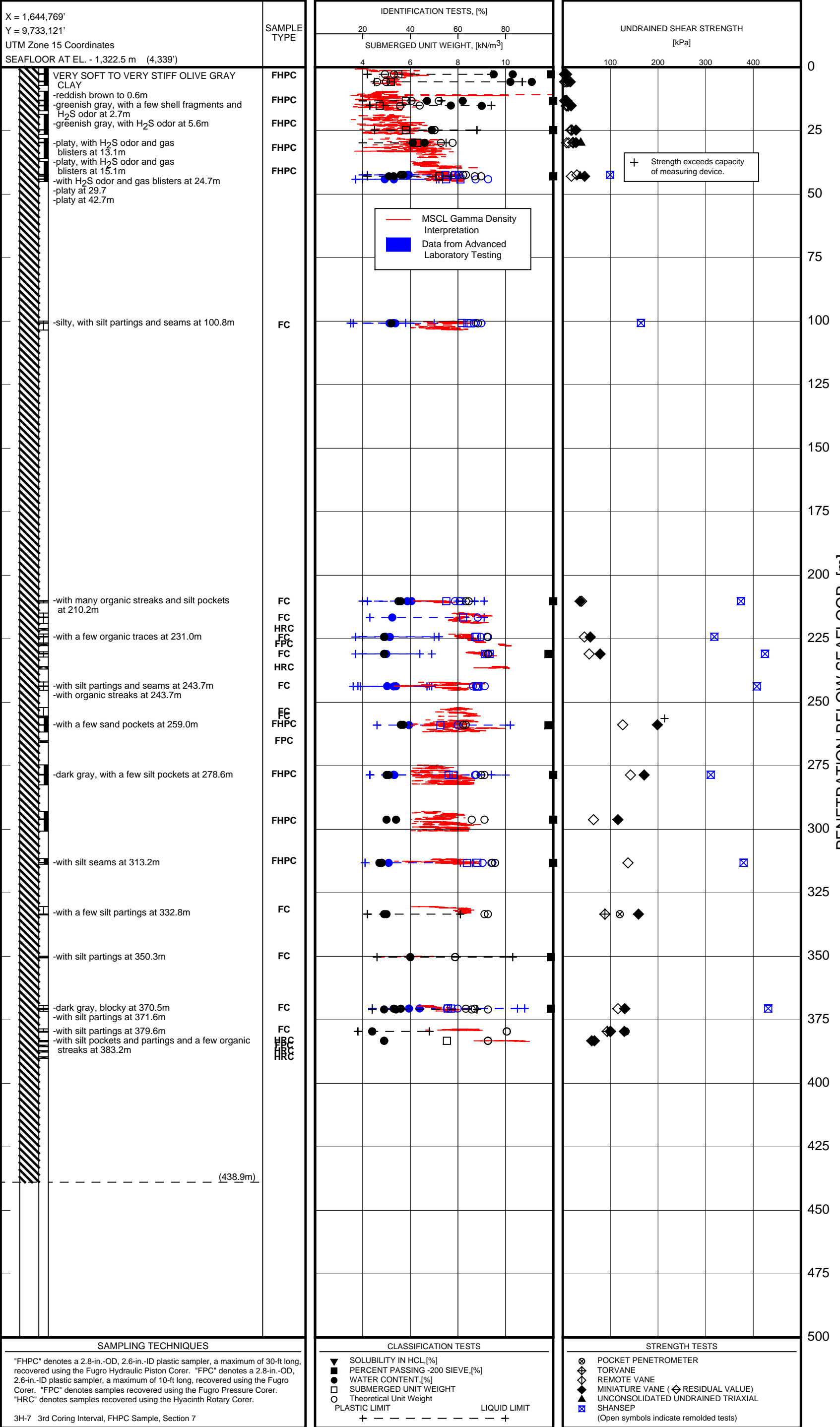

SAMPLING TECHNIQUES

"FHPC" denotes a 2.8-in.-OD, 2.6-in.-ID plastic sampler, a maximum of 30-ft long, recovered using the Fugro Hydraulic Piston Corer. "FPC" denotes a 2.8-in.-OD, 2.6-in.-ID plastic sampler, a maximum of 10-ft long, recovered using the Fugro Corer. "FC" denotes samples recovered using the Fugro Pressure Corer. "HRC" denotes samples recovered using the Hyacinth Rotary Corer.

3H-7 3rd Coring Interval, FHPC Sample, Section 7

CLASSIFICATION TESTS

- ▼ SOLUBILITY IN HCL, [%]
- PERCENT PASSING -200 SIEVE, [%]
- WATER CONTENT, [%]
- SUBMERGED UNIT WEIGHT
- Theoretical Unit Weight
- PLASTIC LIMIT
- LIQUID LIMIT

STRENGTH TESTS

- ◇ POCKET PENETROMETER
- ◇ TORVANE
- ◇ REMOTE VANE
- ◇ MINIATURE VANE (◇ RESIDUAL VALUE)
- ◇ UNCONSOLIDATED UNDRAINED TRIAXIAL
- ◇ SHANSEP
- (Open symbols indicate remolded tests)

LOG OF BORING AND TEST RESULTS
Boring KC151#3
Block 151, Keathley Canyon Area, Gulf of Mexico



Report No. 0201-5081 (Section 1)

PENETRATION BELOW SEAFLOOR, [m]

PLATE I-3c

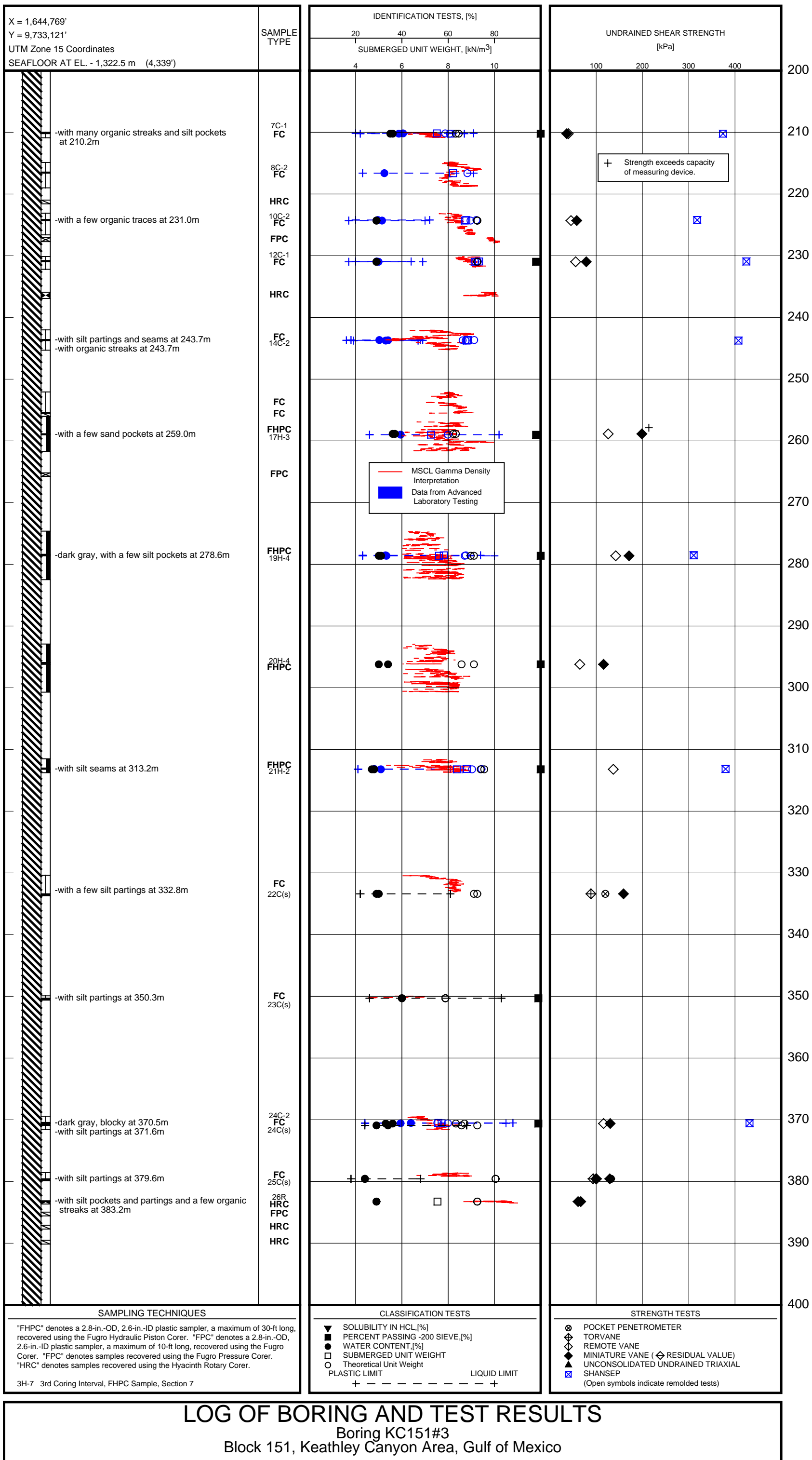

Report No. 0201-5081 (Section 1)

PENETRATION BELOW SEAFLOOR, [m]

PENETRATION BELOW SEAFLOOR, [m]

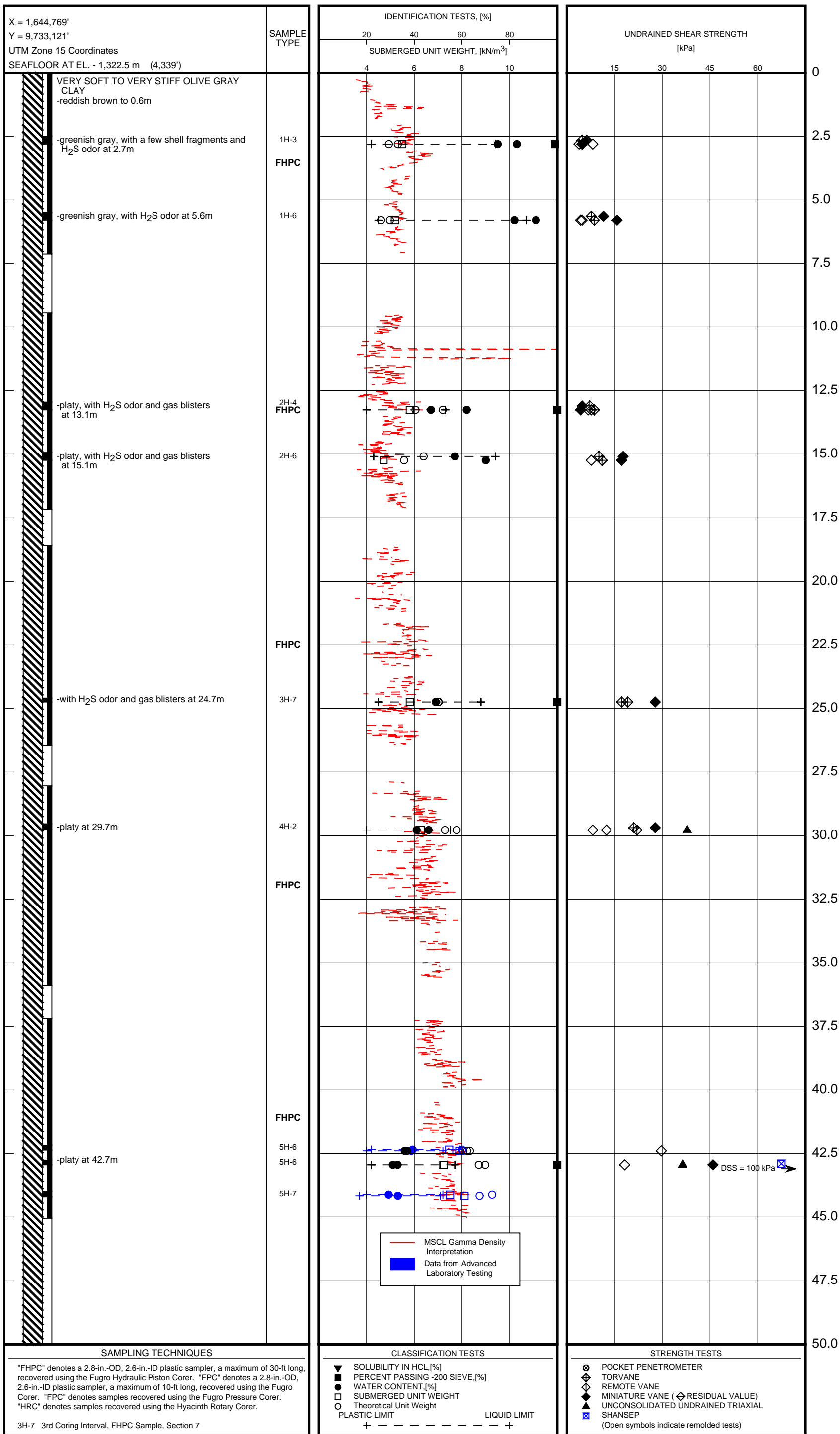

3H-7 3rd Coring Interval, FHPC Sample, Section 7

LOG OF BORING AND TEST RESULTS

Boring KC151#3
 Block 151, Keathley Canyon Area, Gulf of Mexico

PLATE I-3b



Checked By: _____ Date: _____
 Approved By: _____ Date: _____

Drawn By: _____ Date: _____

Report No. 0201-6081 (Section 1)

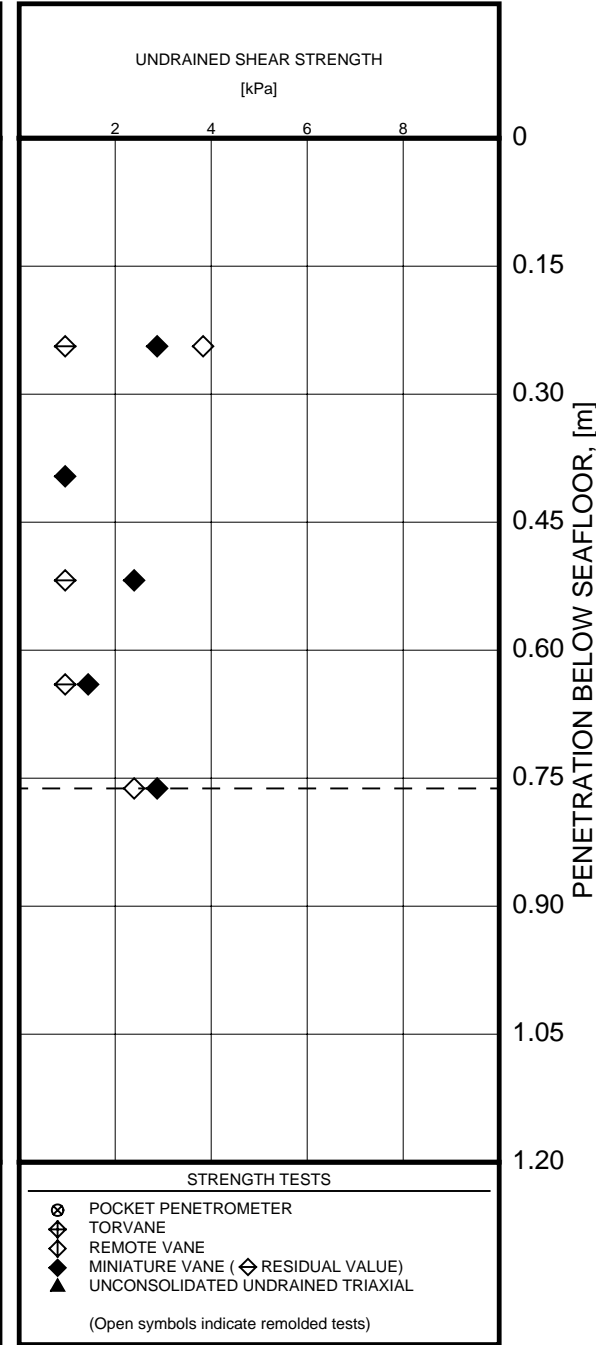
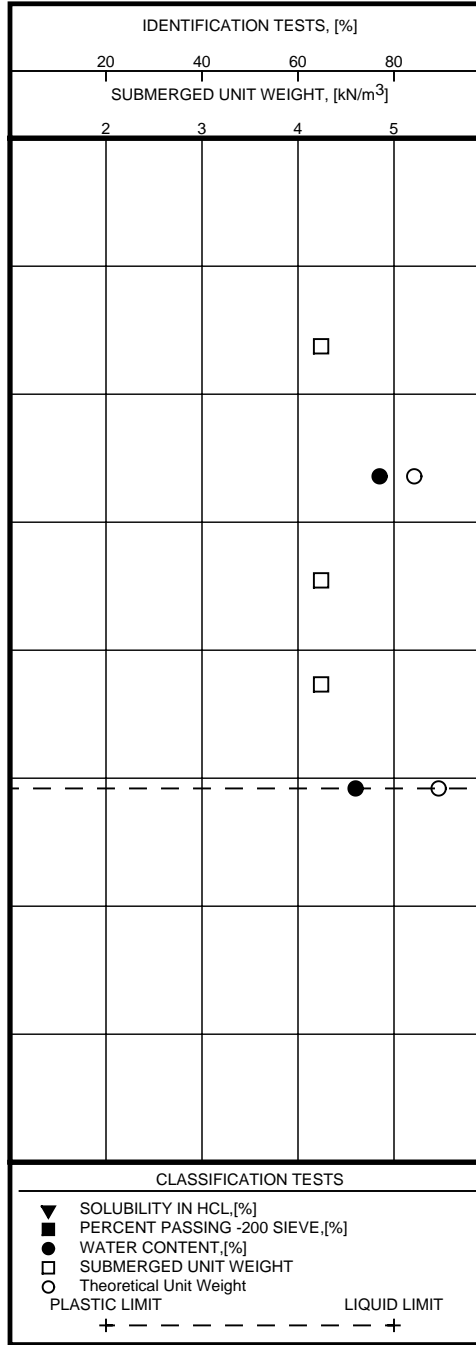
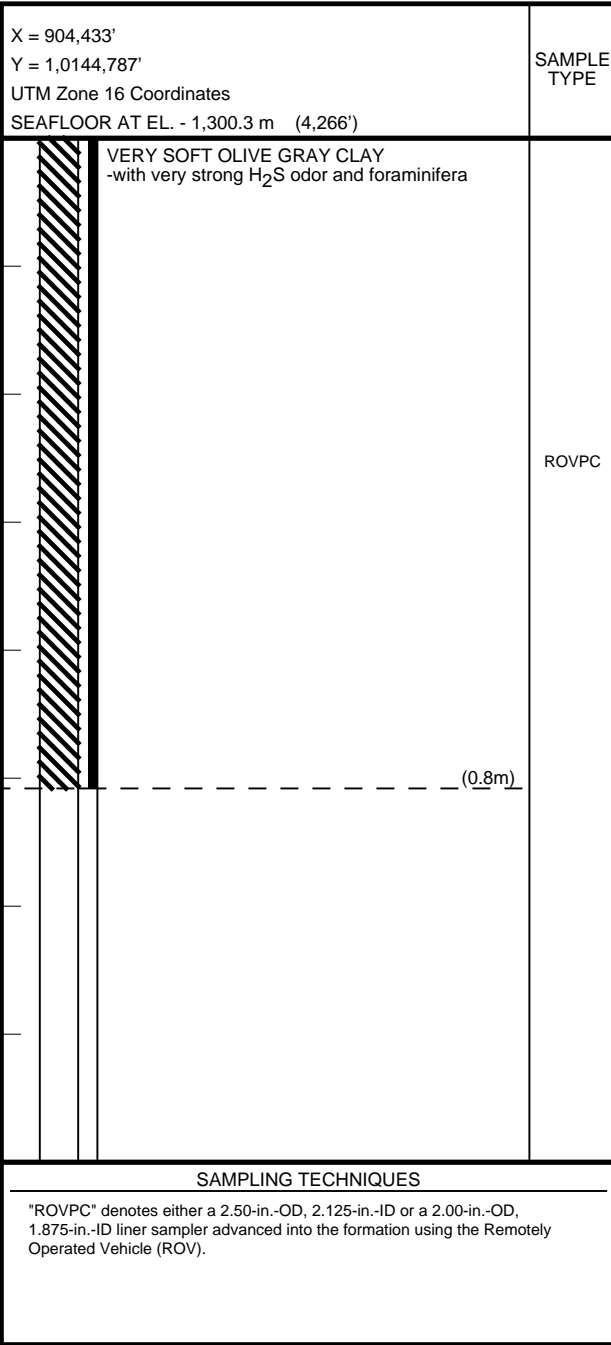

PLATE I-4

LOG OF ROV PUSH CORE AND TEST RESULTS

ROV Push Core PC#2
 Block 14, Atwater Valley Area, Gulf of Mexico



Checked By: _____ Date: _____
 Approved By: _____ Date: _____

Drawn By: _____ Date: _____

Report No. 0201-6081 (Section 1)

PLATE I-5

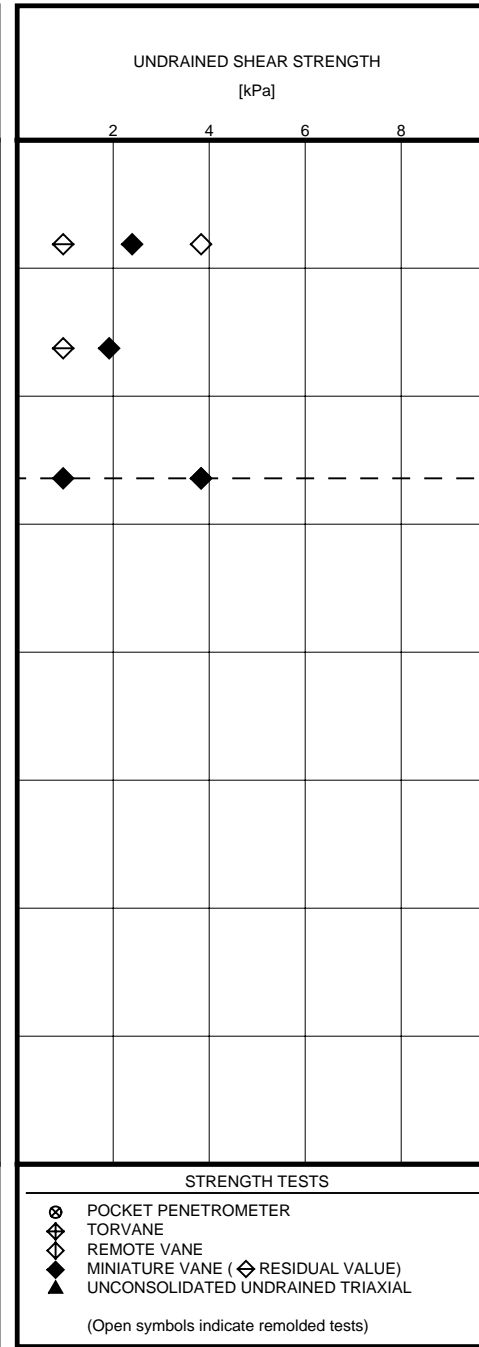
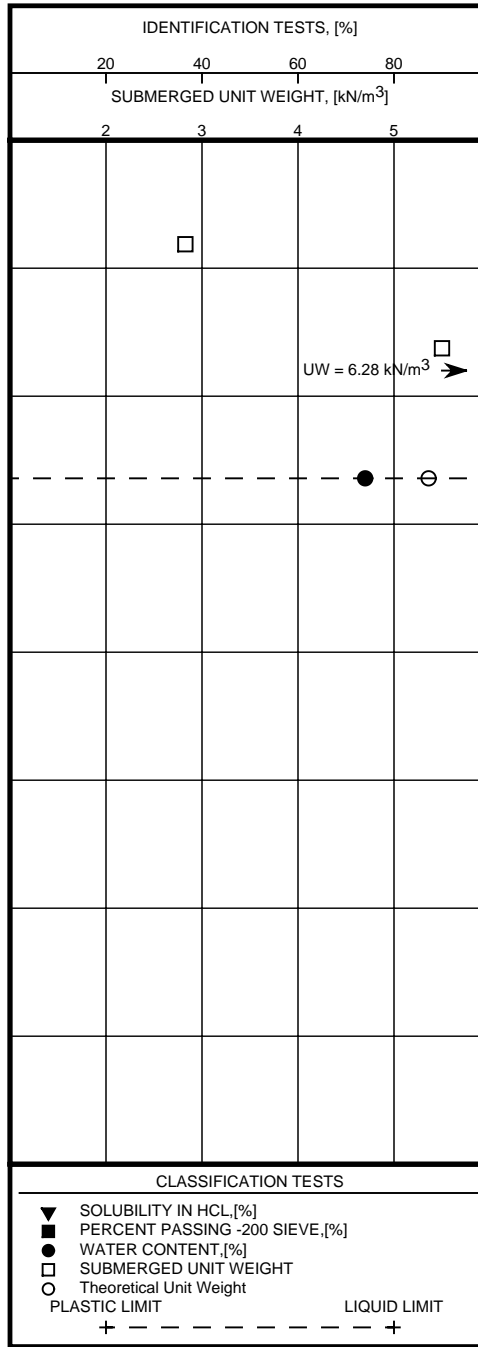
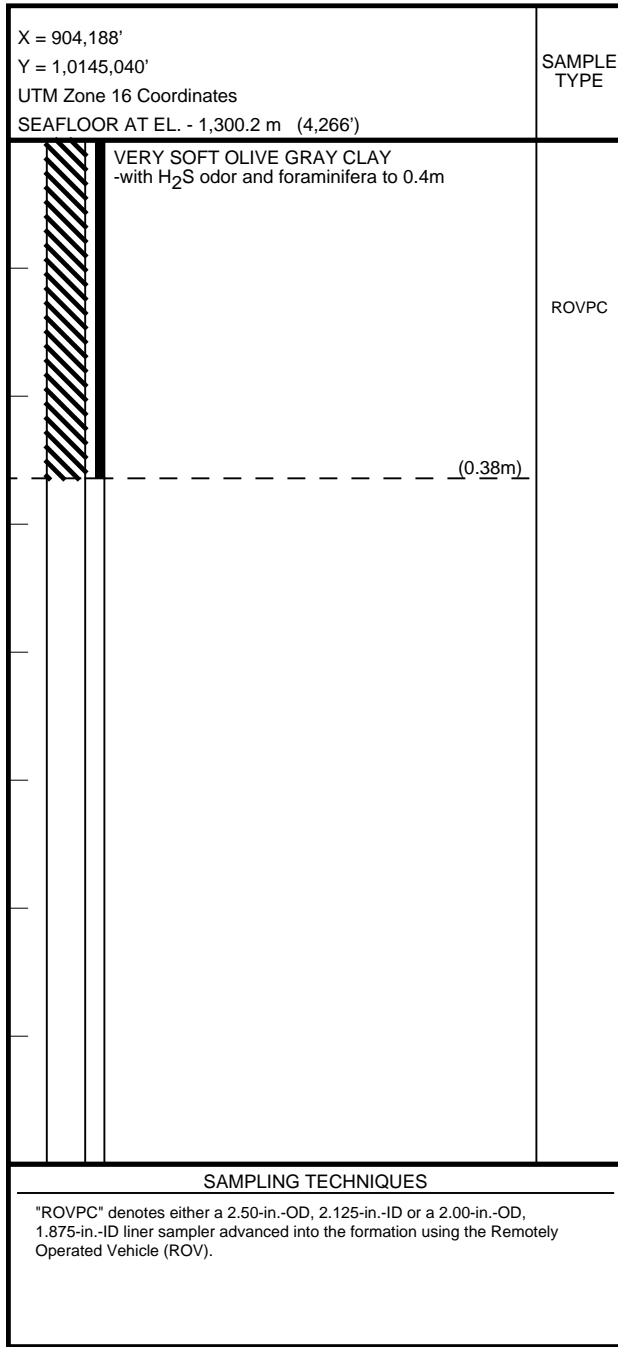

LOG OF ROV PUSH CORE AND TEST RESULTS
 ROV Push Core PC#7
 Block 14, Atwater Valley Area, Gulf of Mexico



Report No. 0201-6081 (Section I)

PLATE I-6

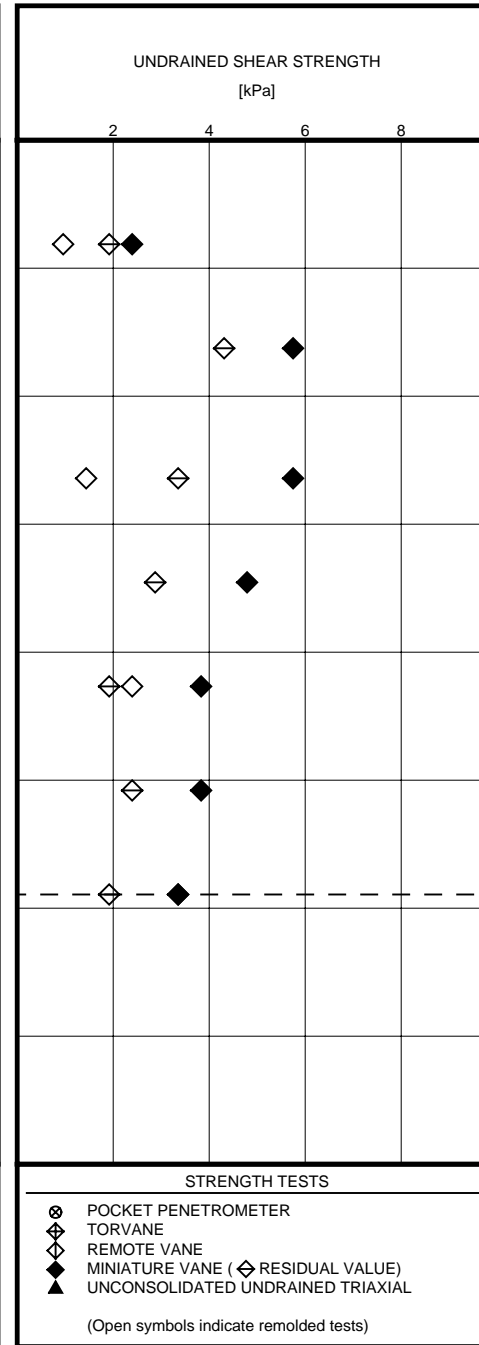
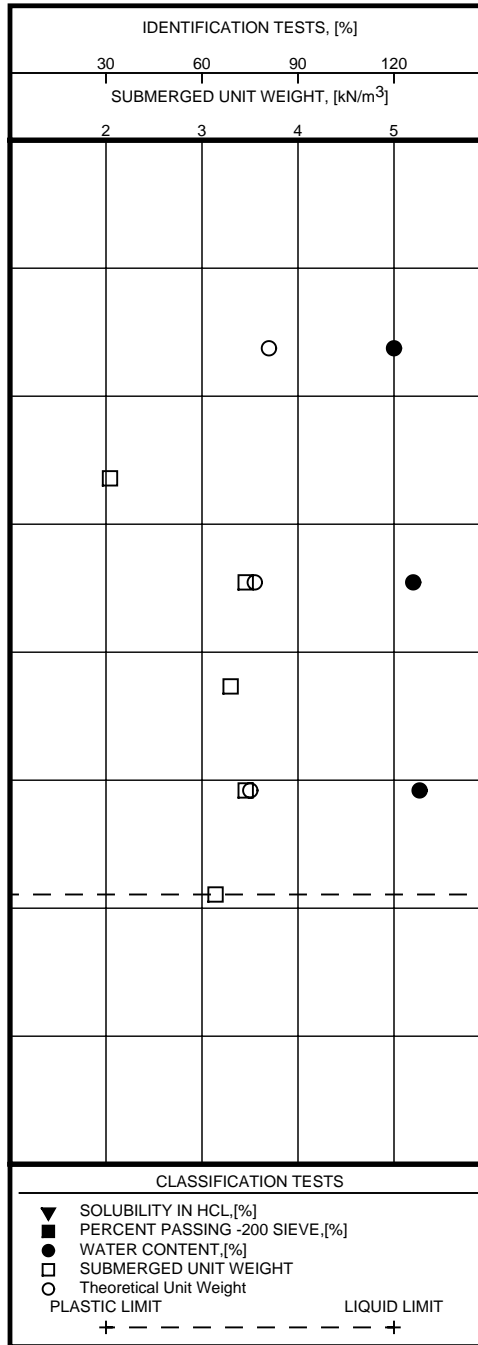
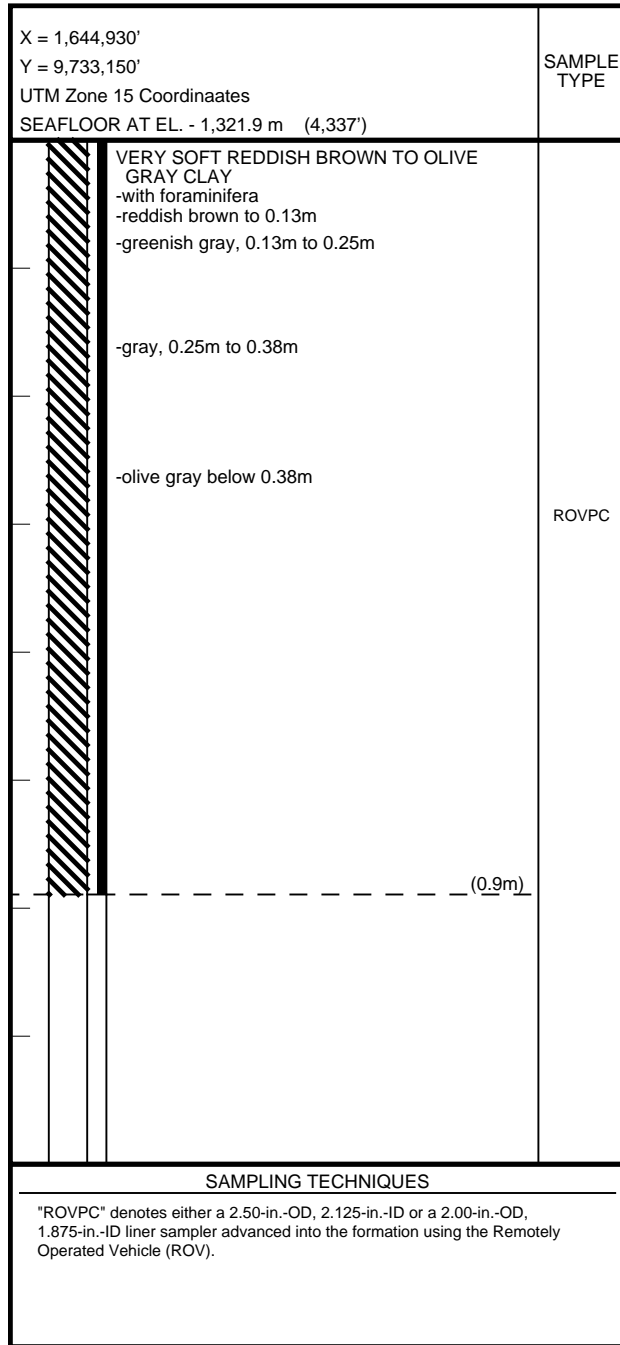

LOG OF BORING AND TEST RESULTS

ROV Push Core PC#2
Block 151, Keathley Canyon Area, Gulf of Mexico



TERMS AND SYMBOLS USED ON BORING AND ROV PUSH CORE LOG

SOIL TYPES

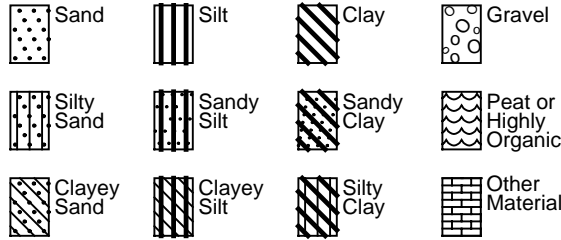

SAMPLER TYPES

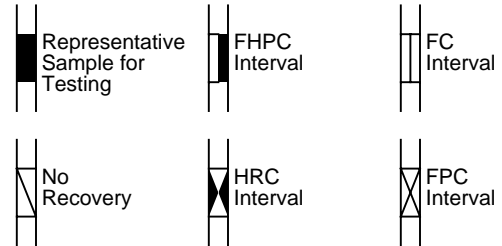

SOIL GRAIN SIZE U.S. STANDARD SIEVE

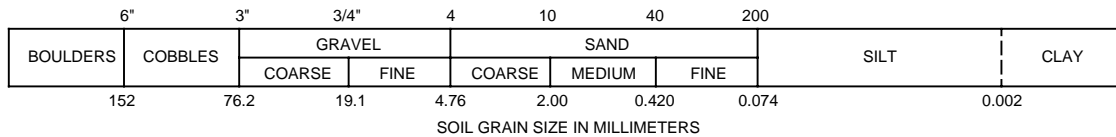

STRENGTH OF COHESIVE SOILS ⁽¹⁾

Consistency	Undrained Shear Strength, (kPa)
Very Soft.....	less than 12
Soft.....	12 to 25
Firm.....	25 to 50
Stiff.....	50 to 100
Very Stiff.....	100 to 200
Hard.....	200 to 400
Very Hard.....	greater than 400

DENSITY OF GRANULAR SOILS ^(2,3)

Descriptive Term	*Relative Density, %
Very Loose.....	less than 15
Loose.....	15 to 35
Medium Dense.....	35 to 65
Dense.....	65 to 85
Very Dense.....	greater than 85

*Estimated from sampler driving record

SOIL STRUCTURE ⁽¹⁾

Slickensided.....	Having planes of weakness that appear slick and glossy. The degree of slickensidedness depends upon the spacing of slickensides and the ease of breaking along these planes.
Fissured.....	Containing shrinkage or relief cracks, often filled with fine sand or silt, usually more or less vertical.
Pocket.....	Inclusion of material of different texture that is smaller than the diameter of the sample.
Parting.....	Inclusion less than 3 mm thick extending through the sample.
Seam.....	Inclusion 3 mm to 76 mm thick extending through the sample.
Layer.....	Inclusion greater than 76 mm thick extending through the sample.
Laminated.....	Soil sample composed of alternating partings or seams of different soil types.
Interlayered.....	Soil sample composed of alternating layers of different soil types.
Intermixed.....	Soil sample composed of pockets of different soil types and layered or laminated structure is not evident.
Calcareous.....	Having appreciable quantities of carbonate.

REFERENCES:

- (1) ASTM D 2488
- (2) ASCE Manual 56 (1976)
- (3) ASTM D 2049

Information on each boring log is a compilation of subsurface conditions and soil or rock classifications obtained from the field as well as from laboratory testing of samples. Strata have been interpreted by commonly accepted procedures. The stratum lines on the log may be transitional and approximate in nature. Water level measurements refer only to those observed at the times and places indicated in the text, and may vary with time, geologic condition or construction activity.

Date:

Drawn By:

Date:
Date:

Checked By:
Approved By:

Date:

Drawn By:

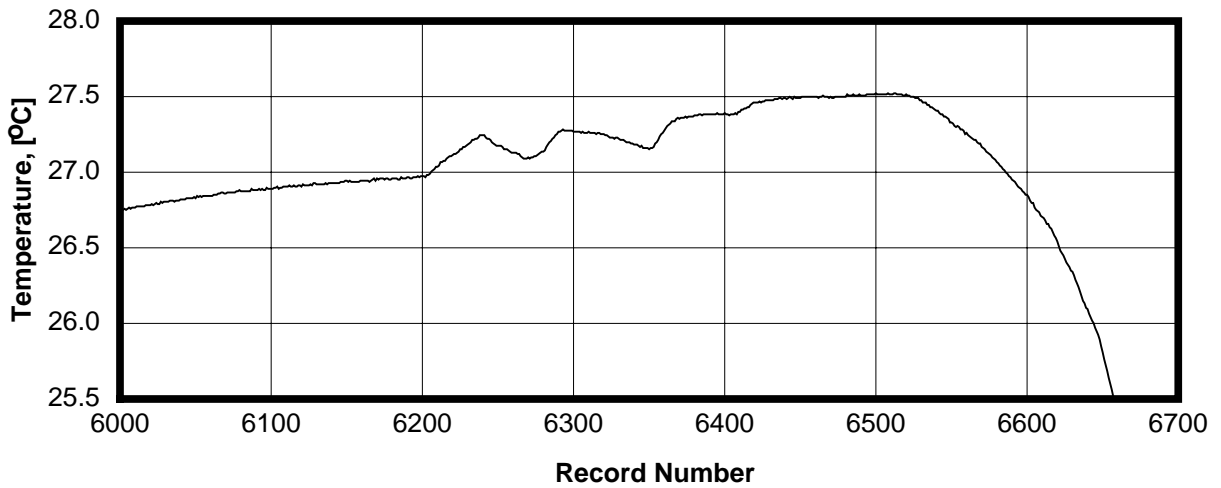
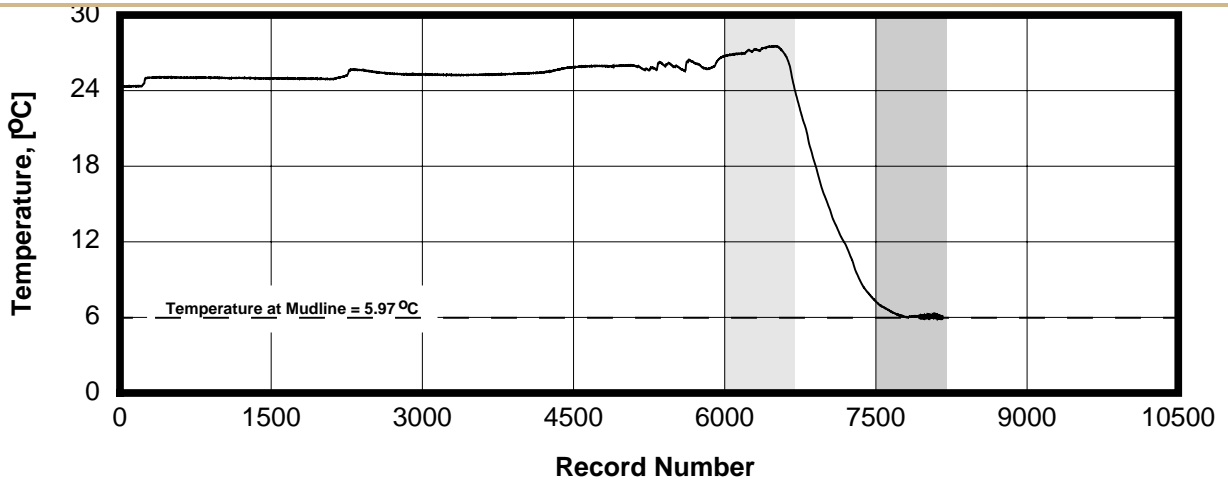

Date:

Date:

Checked By:

Approved By:

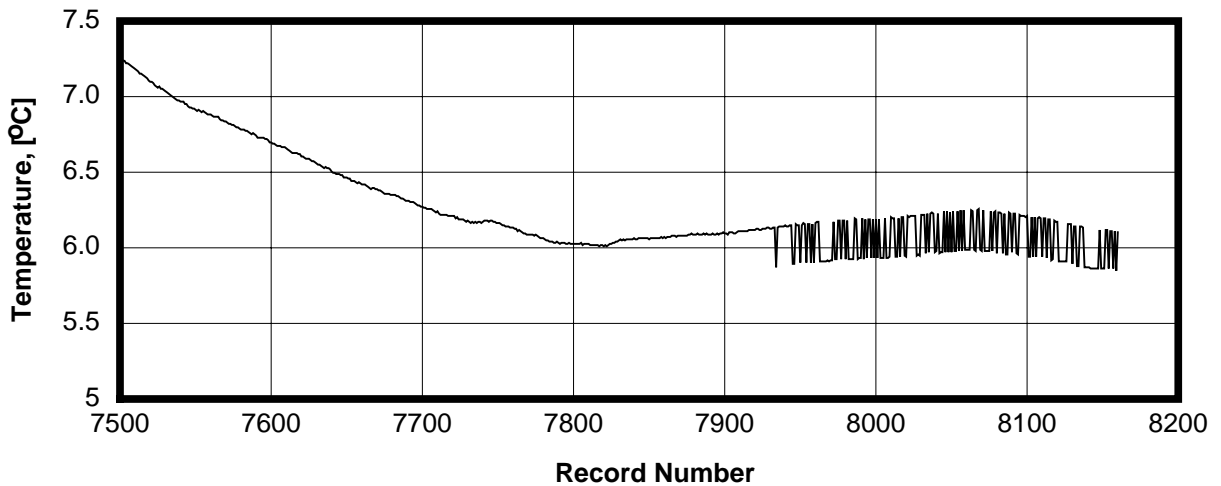

APCT TEST DATA
 APCT Deployment at 15.54 m (51.0-ft) Penetration
 Boring AT13#2, Core FHPC 2H
 CVX Gulf of Mexico Gas Hydrates JIP
 Block 13, Atwater Valley Area, Gulf of Mexico

Date:

Drawn By:

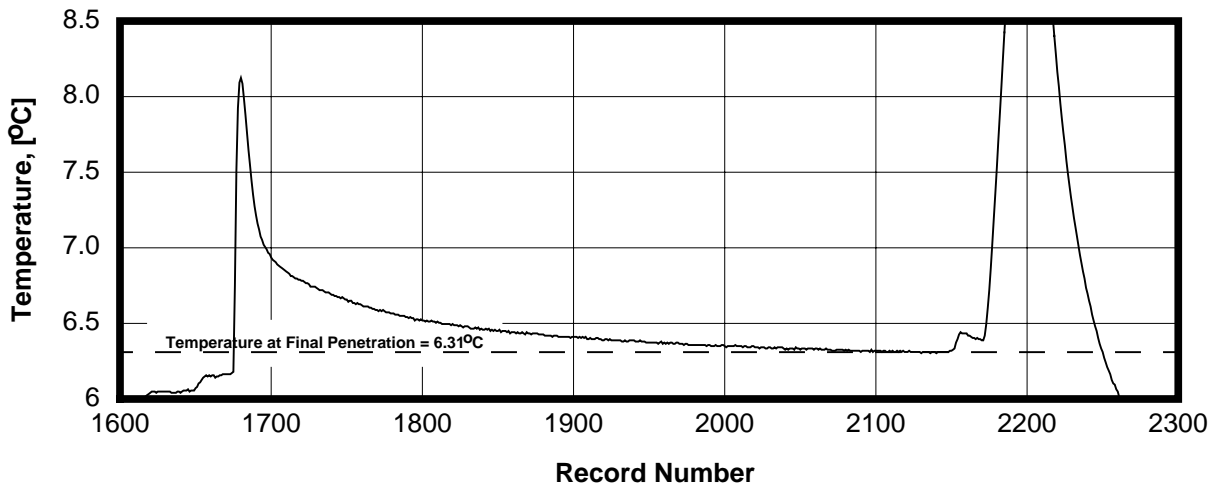
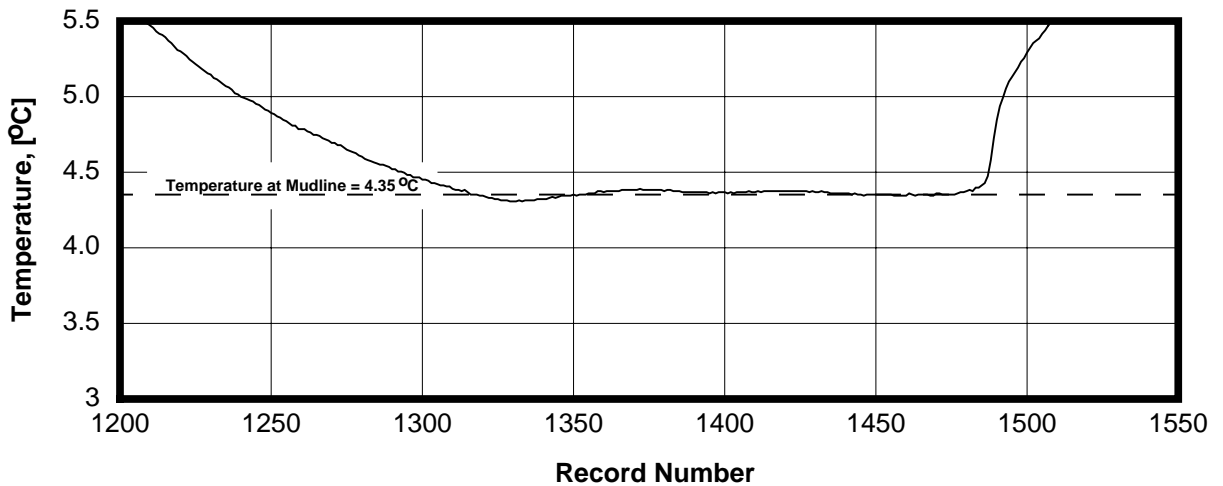
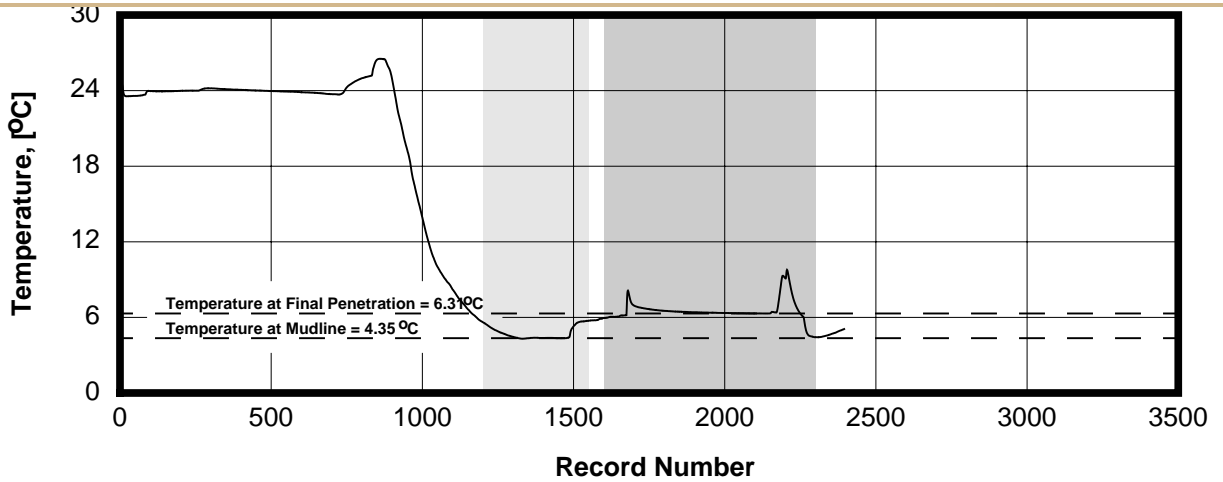

Date:

Date:

Checked By:

Approved By:

APCT TEST DATA
 APCT Deployment at 46.63 m (153.0-ft) Penetration
 Boring AT13#2, Core FHPC 8H
 CVX Gulf of Mexico Gas Hydrates JIP
 Block 13, Atwater Valley Area, Gulf of Mexico

Date:

Drawn By:

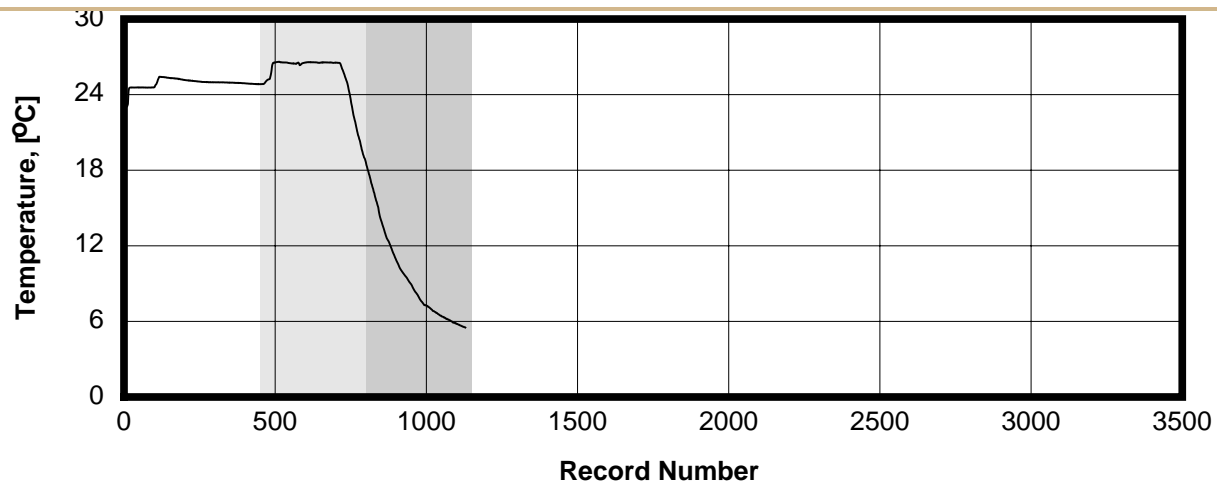

Date:

Checked By:
Approved By:

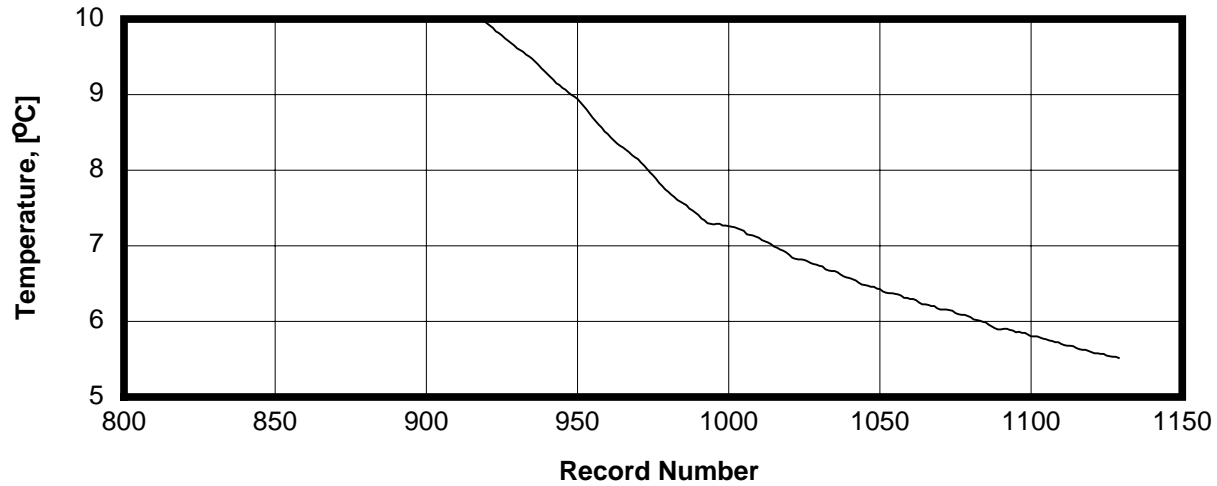
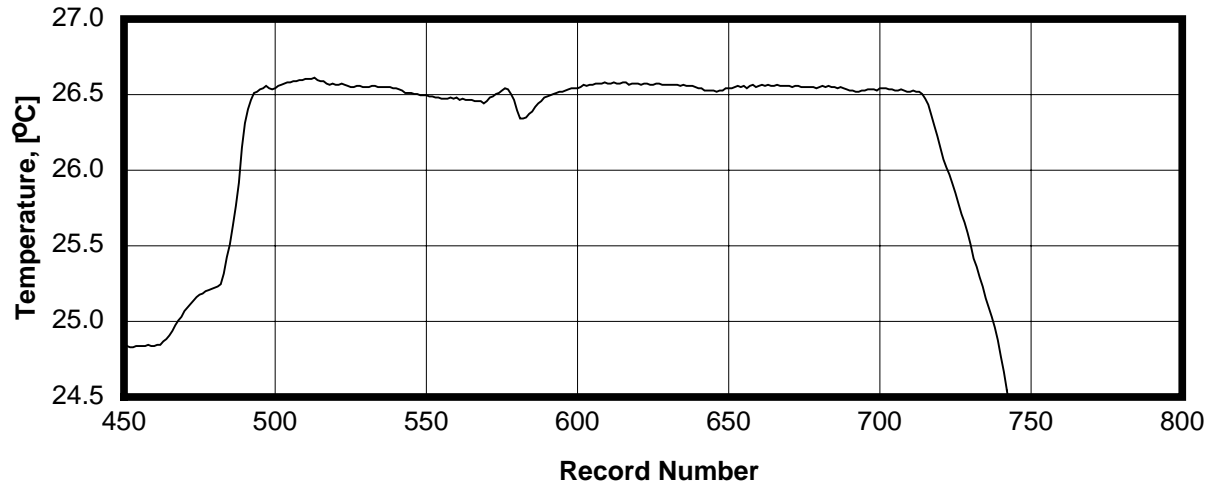

APCT TEST DATA
 APCT Deployment at 133.81 m (439.0-ft) Penetration
 Boring AT13#2, Core FHPC 11H
 CVX Gulf of Mexico Gas Hydrates JIP
 Block 13, Atwater Valley Area, Gulf of Mexico

Date:

Drawn By:

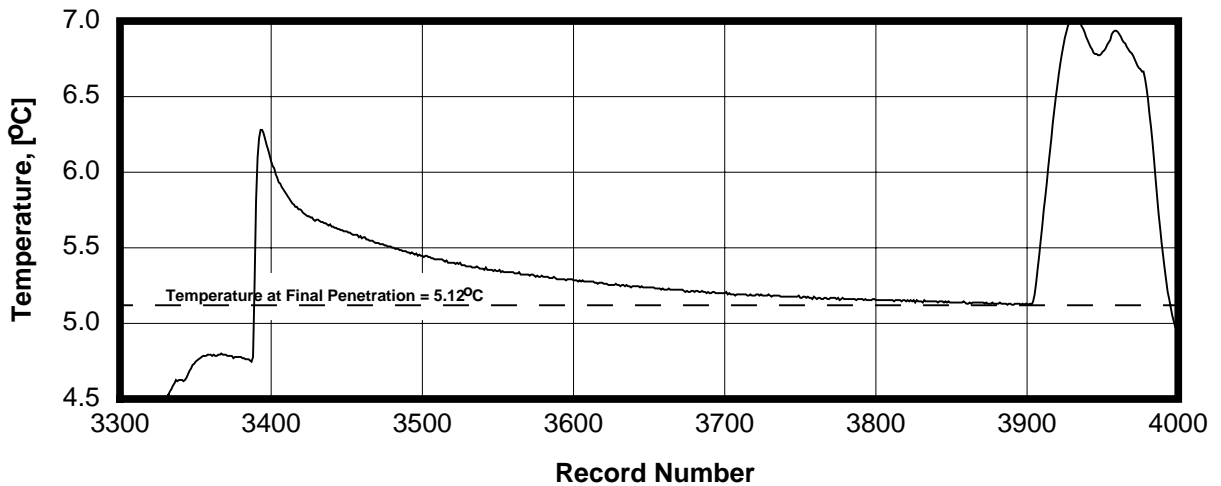
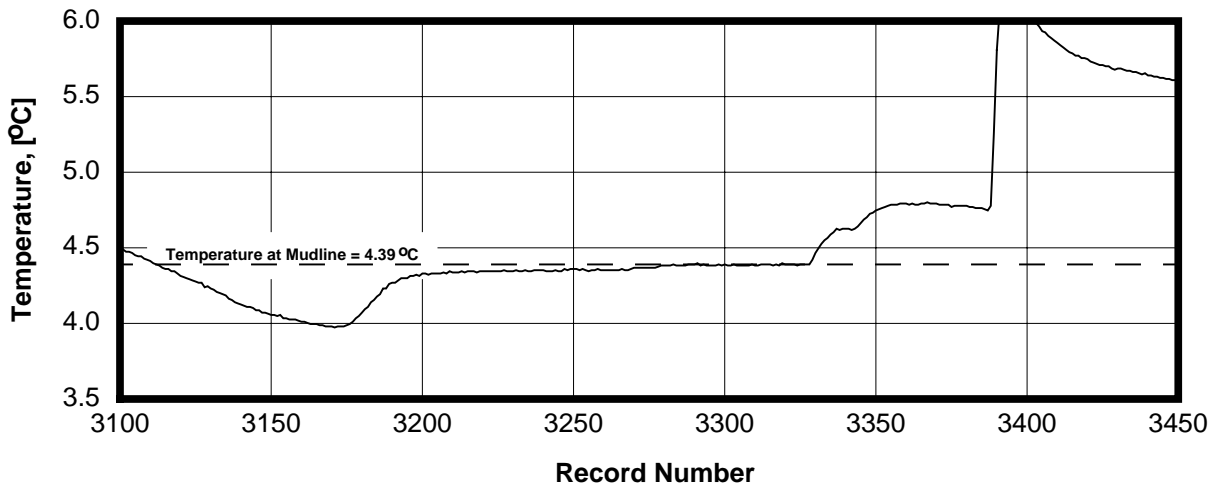
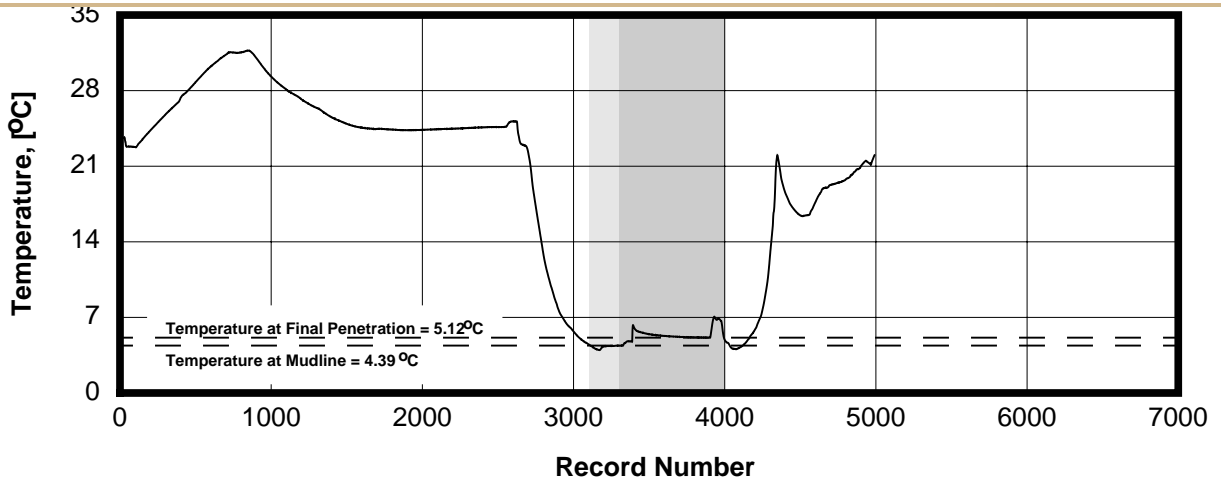

Date:

Date:

Checked By:

Approved By:

APCT TEST DATA
 APCT Deployment at 26.06 m (85.5-ft) Penetration
 Boring KC151#3, Core FHPC 3H
 CVX Gulf of Mexico Gas Hydrates JIP
 Block 151, Keathley Canyon Area Area, Gulf of Mexico

Date:

Drawn By:

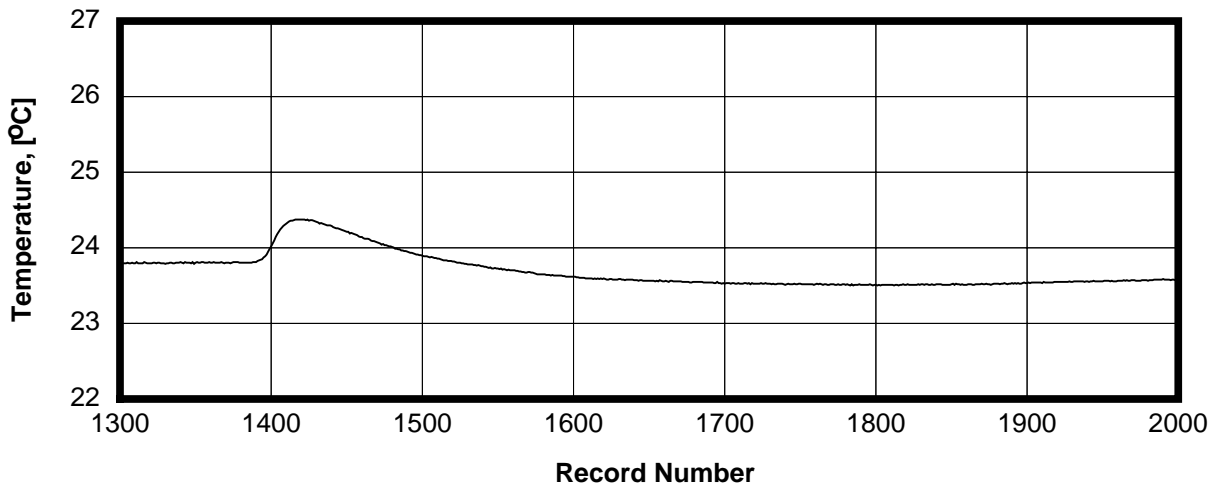
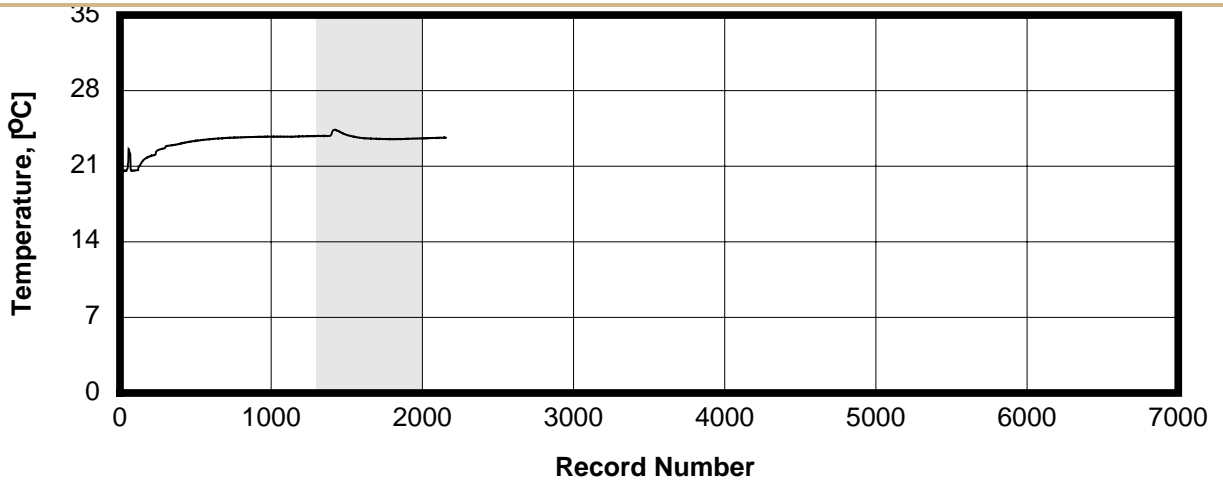

Date:

Date:

Checked By:

Approved By:

APCT TEST DATA
 APCT Deployment at 230.43 m (756.0-ft) Penetration
 Boring KC151#3, Core FHPC 12C
 CVX Gulf of Mexico Gas Hydrates JIP
 Block 151, Keathley Canyon Area Area, Gulf of Mexico

Date:

Drawn By:

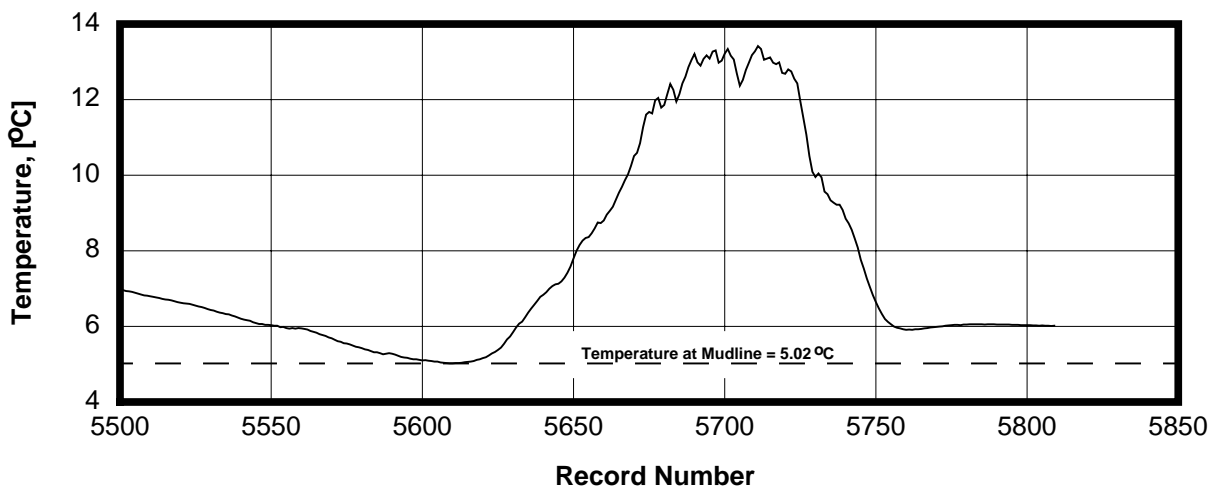
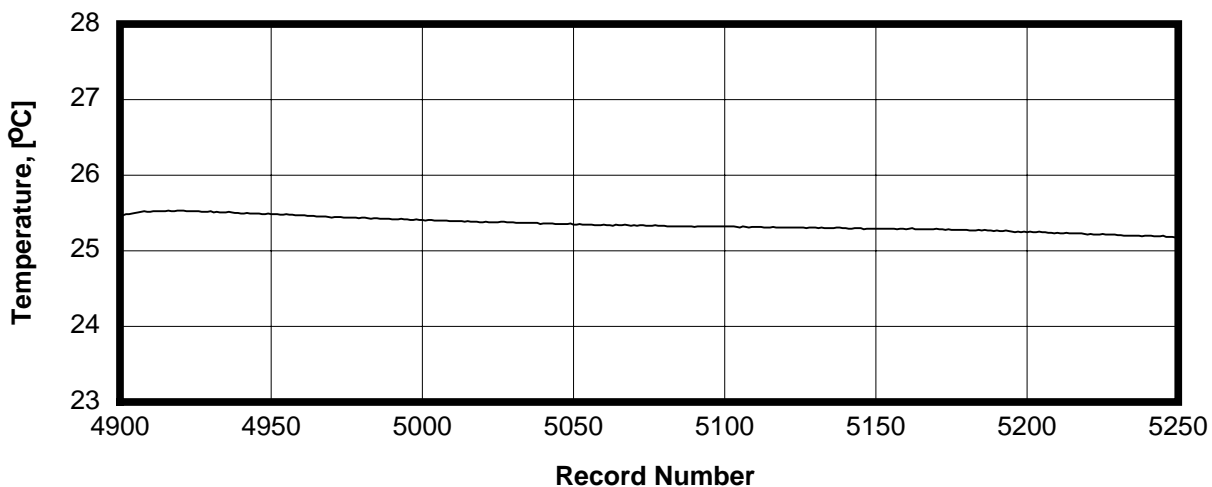
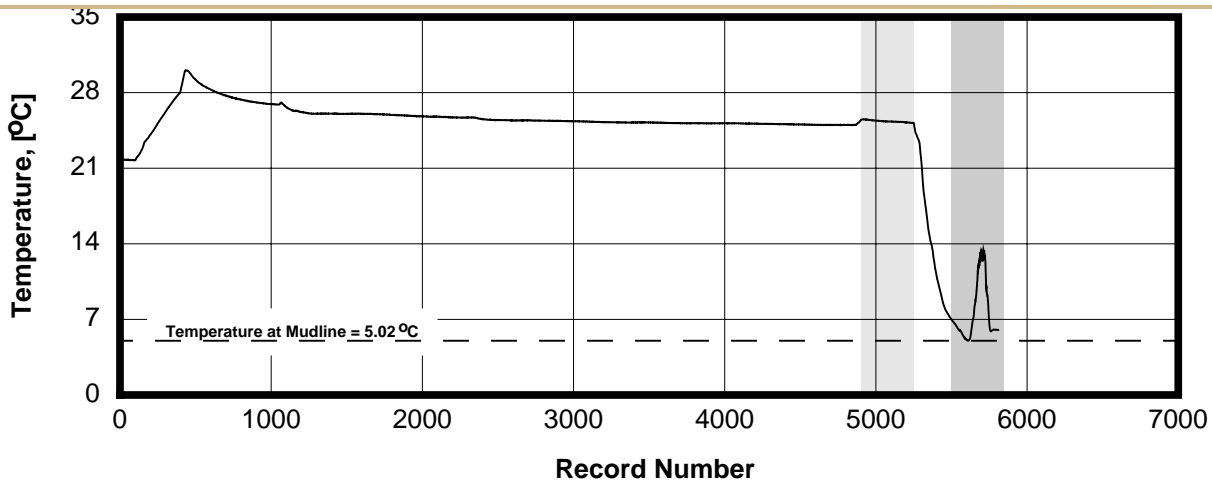

Date:

Date:

Checked By:

Approved By:

APCT TEST DATA
 APCT Deployment at 256.04 m (840.0-ft) Penetration
 Boring KC151#3, Core FHPC 16C
 CVX Gulf of Mexico Gas Hydrates JIP
 Block 151, Keathley Canyon Area Area, Gulf of Mexico

Date:

Drawn By:

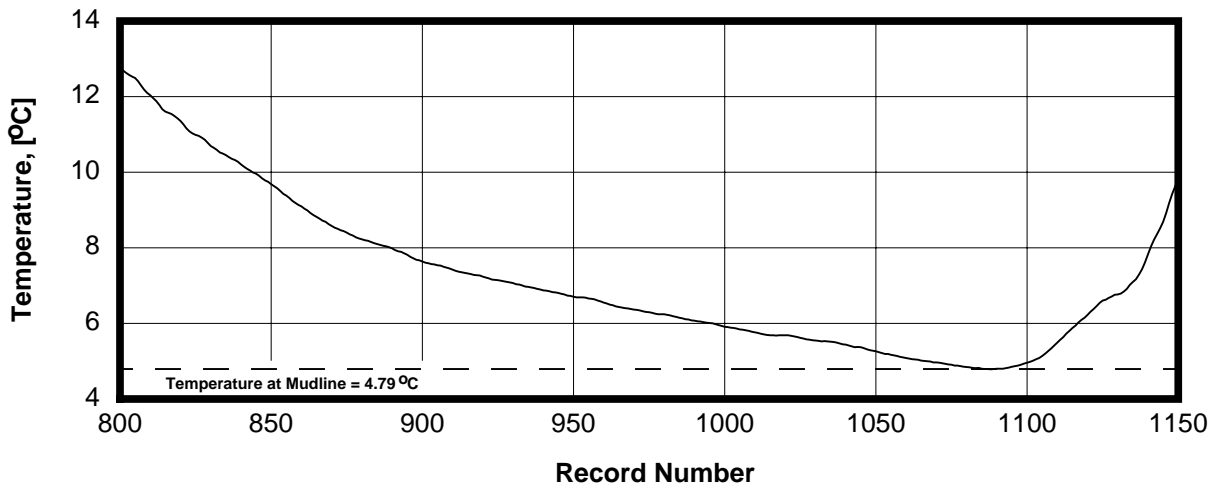
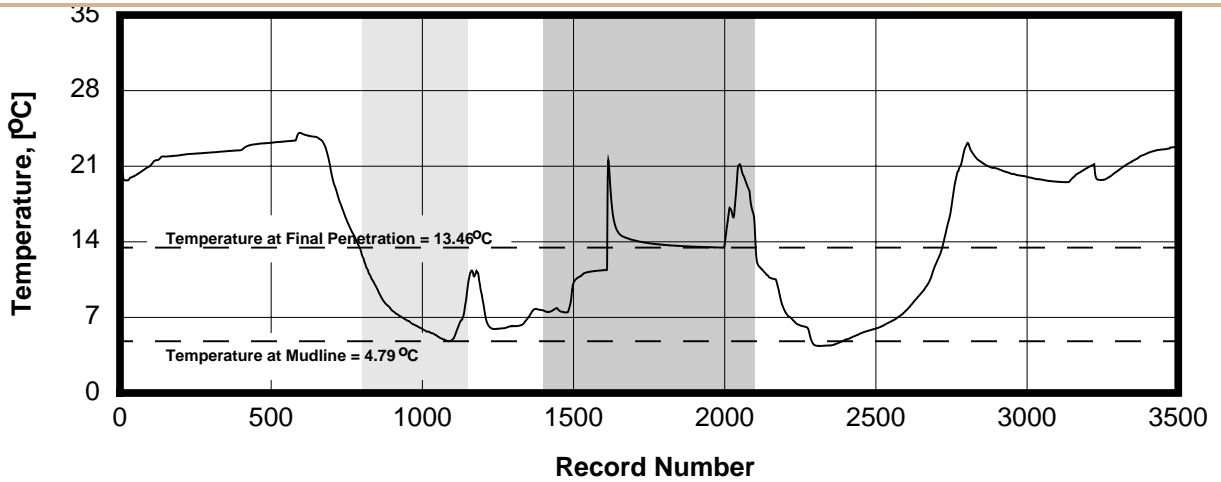

Date:

Date:

Checked By:

Approved By:

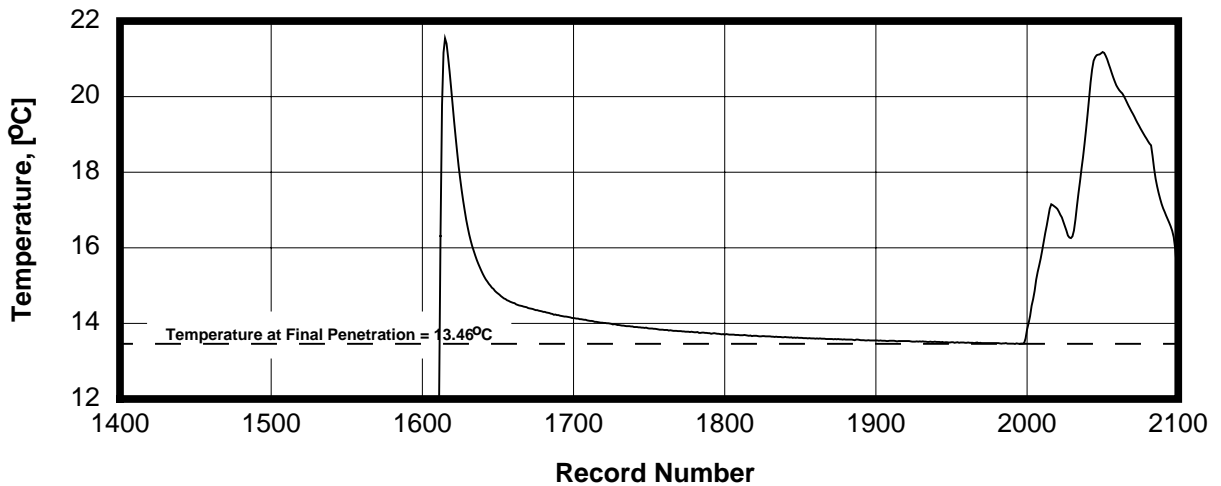

APCT TEST DATA
 APCT Deployment at 300.73 m (986.6-ft) Penetration
 Boring KC151#3, Core FHPC 20H
 CVX Gulf of Mexico Gas Hydrates JIP
 Block 151, Keathley Canyon Area, Gulf of Mexico

Date:

Drawn By:

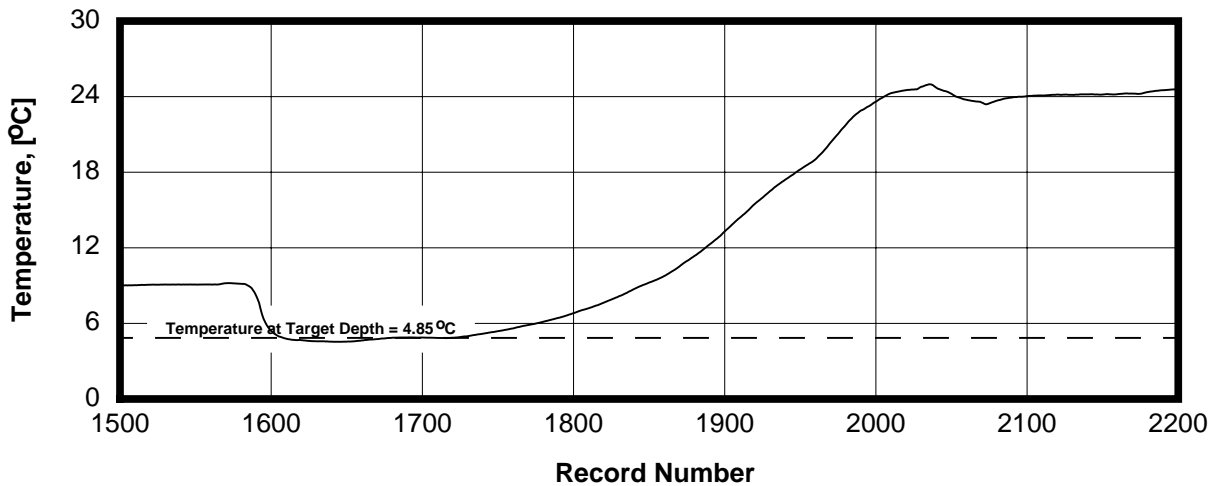
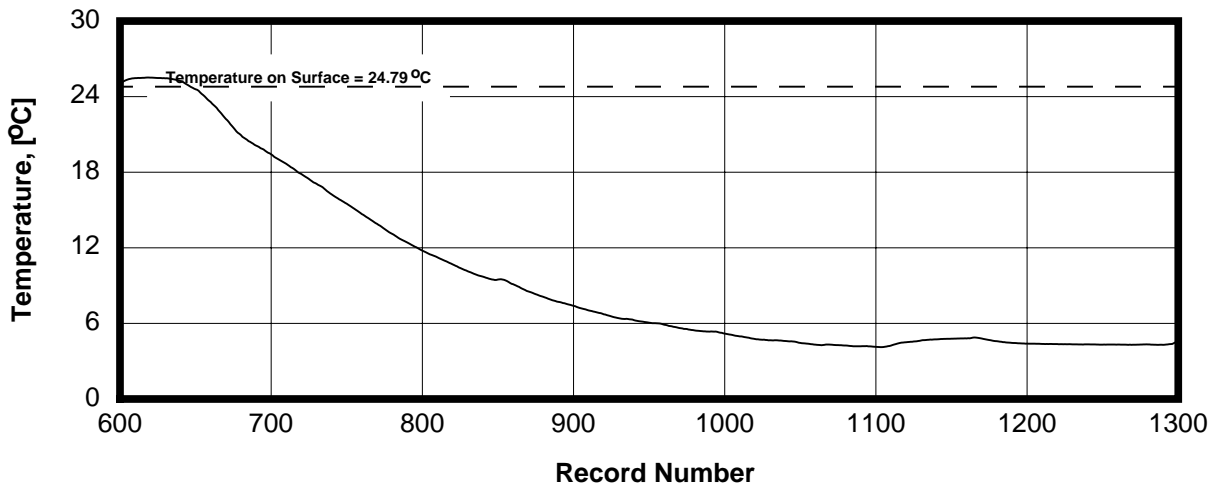
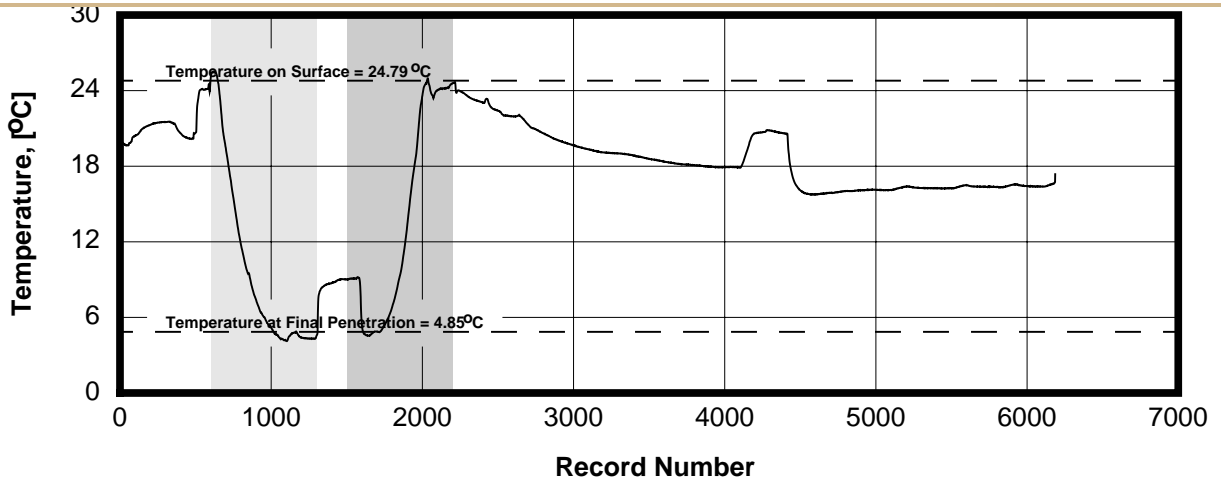

Date:

Date:

Checked By:

Approved By:

APCT TEST DATA
 APCT Deployment at 18.90 m (62.0-ft) Penetration
 Boring ATM-1, Core FHPC 5H
 CVX Gulf of Mexico Gas Hydrates JIP
 Block 14, Atwater Valley Area, Gulf of Mexico

Date:

Drawn By:

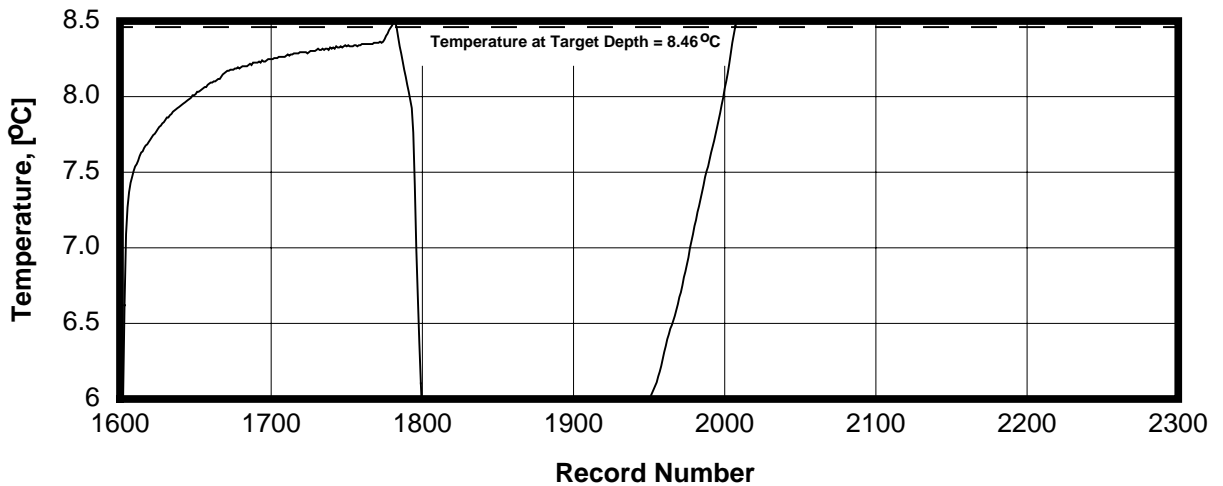
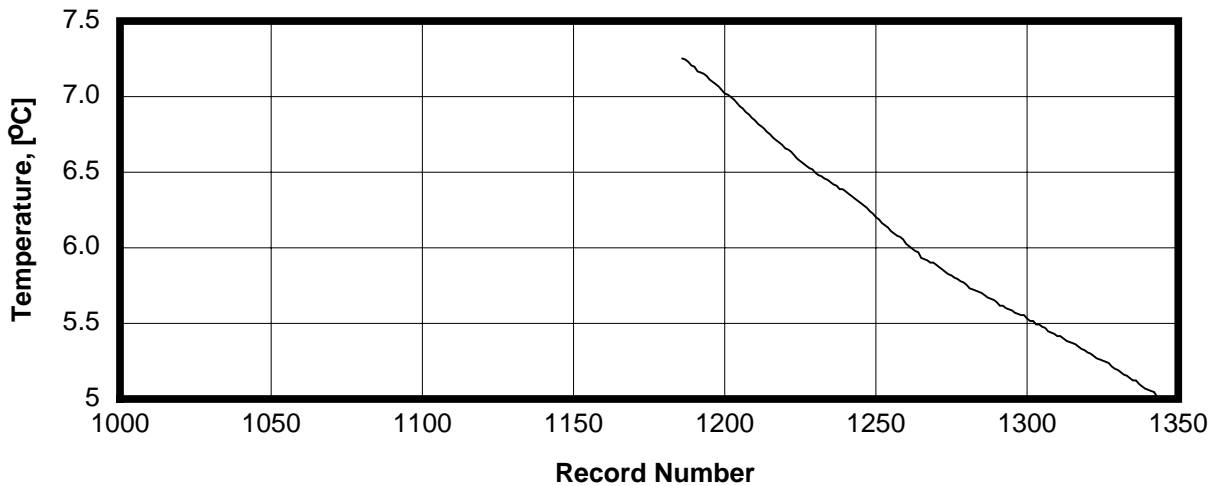
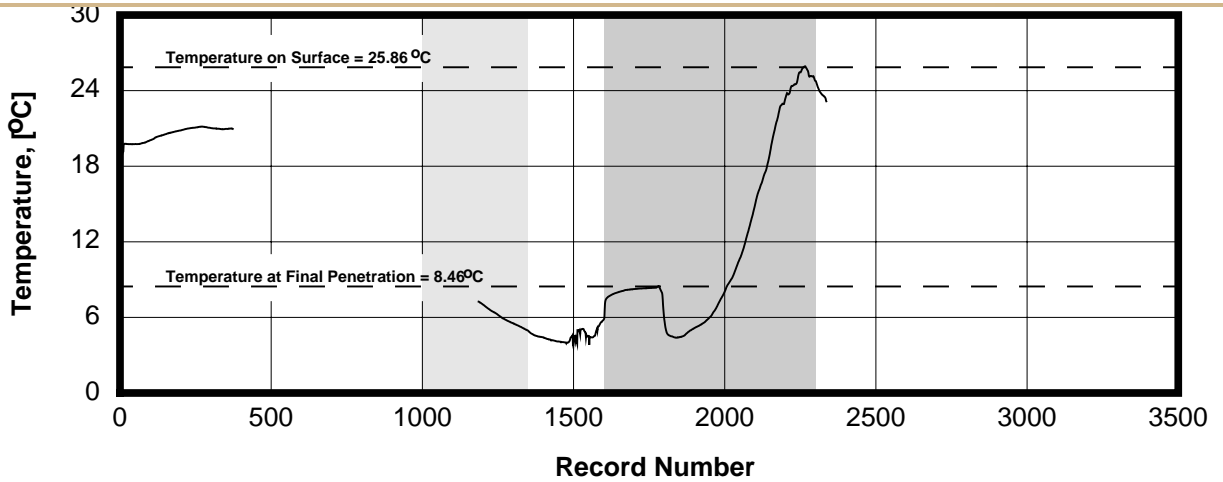

Date:

Date:

Checked By:

Approved By:

APCT TEST DATA
 APCT Deployment at 17.37 m (58.2-ft) Penetration
 Boring ATM-4, Core FHPC 3H
 CVX Gulf of Mexico Gas Hydrates JIP
 Block 14, Atwater Valley Area, Gulf of Mexico

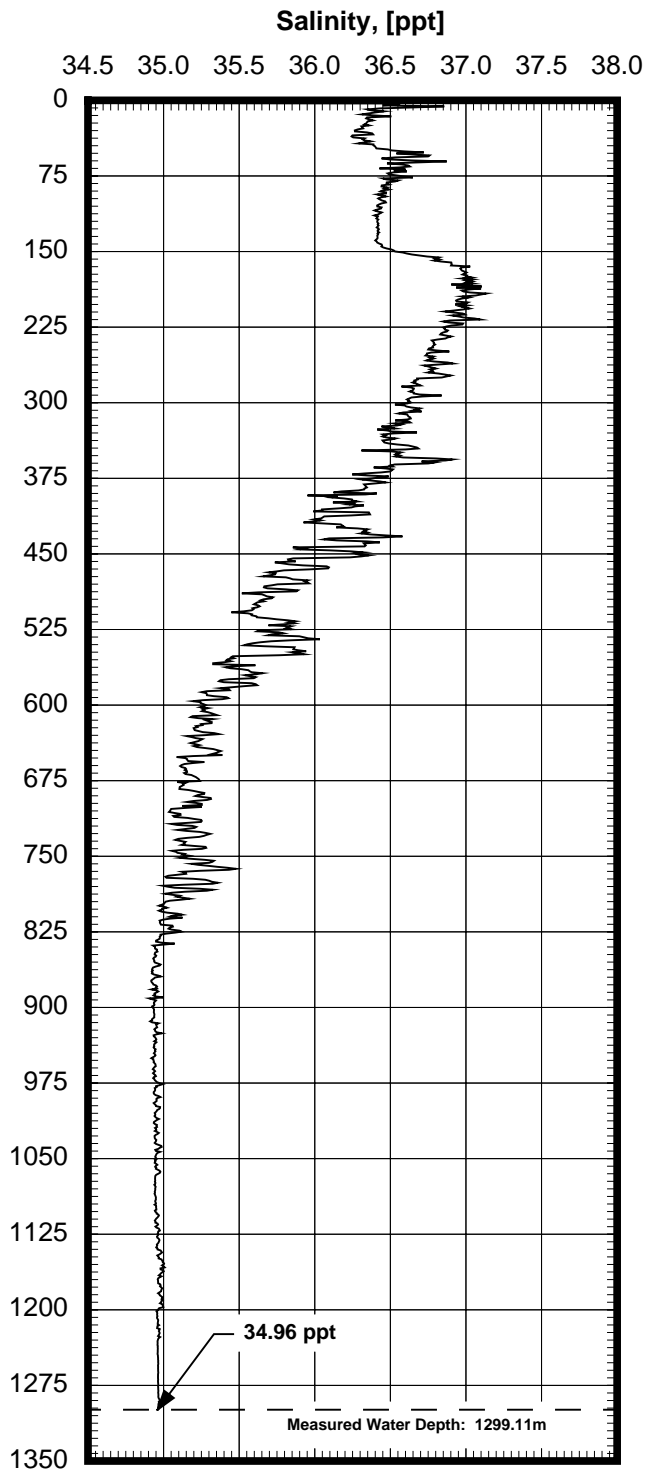
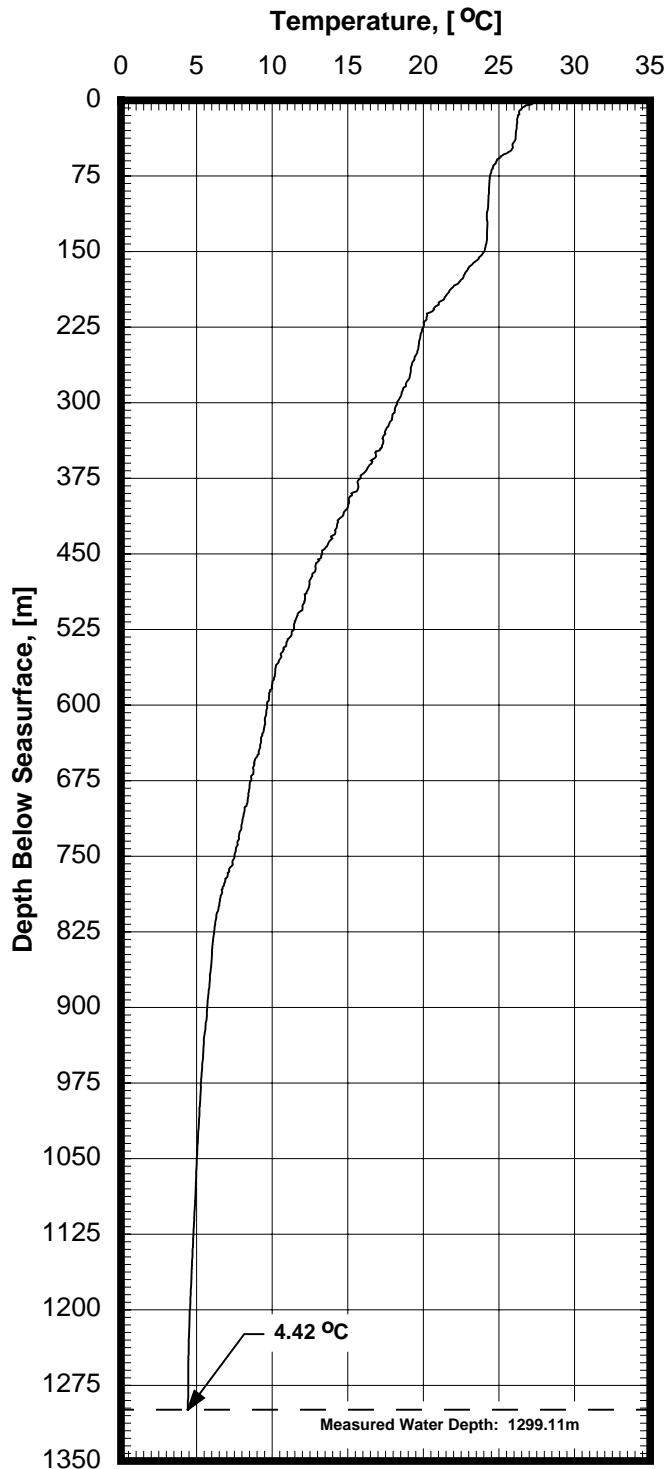

SEABIRD CTD DATA
 SEABIRD CTD Cast at AT13#1
 Well Location AT13#1
 CVX Gulf of Mexico Gas Hydrates JIP
 Block 13, Atwater Valley Area, Gulf of Mexico

Date:

Drawn By:

Date:

Date:

Checked By:

Approved By:

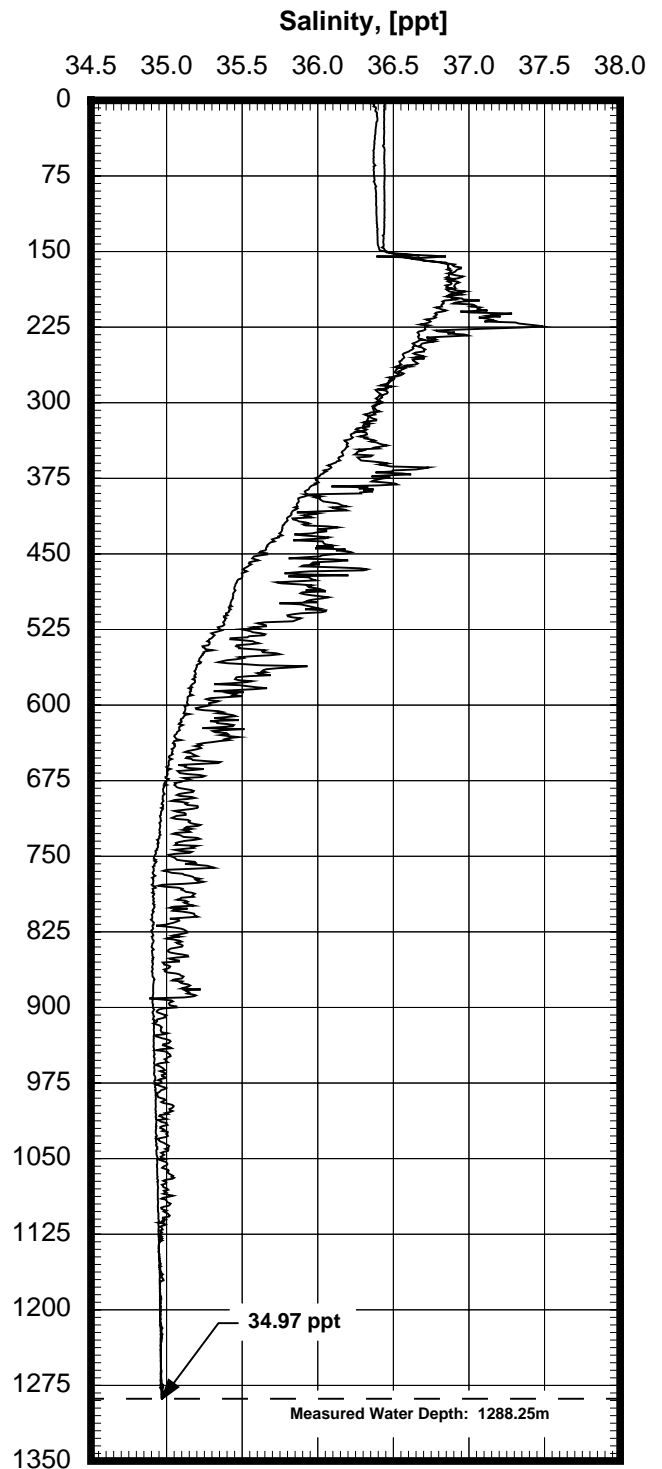
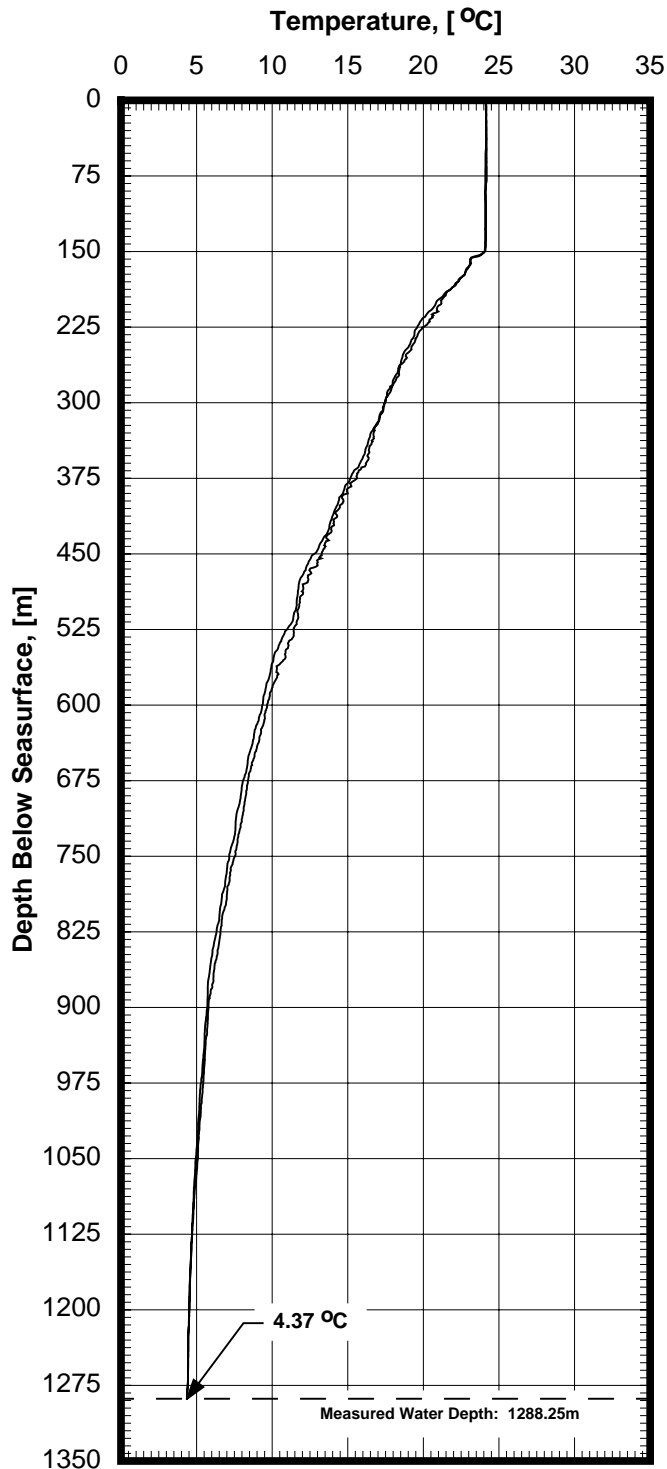

SEABIRD CTD DATA
 SEABIRD CTD Cast at AT13#2
 Well Location AT13#2
 CVX Gulf of Mexico Gas Hydrates JIP
 Block 13, Atwater Valley Area, Gulf of Mexico

Date:

Drawn By:

Date:

Date:

Checked By:

Approved By:

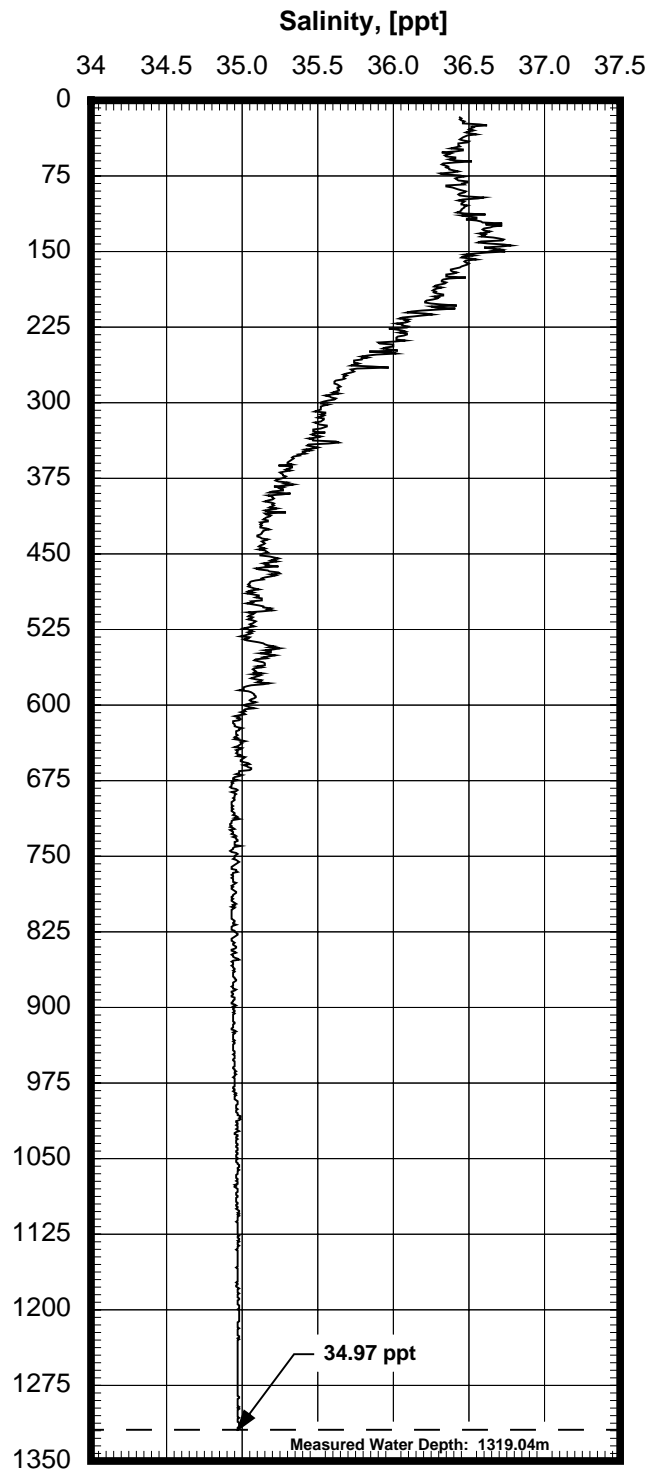
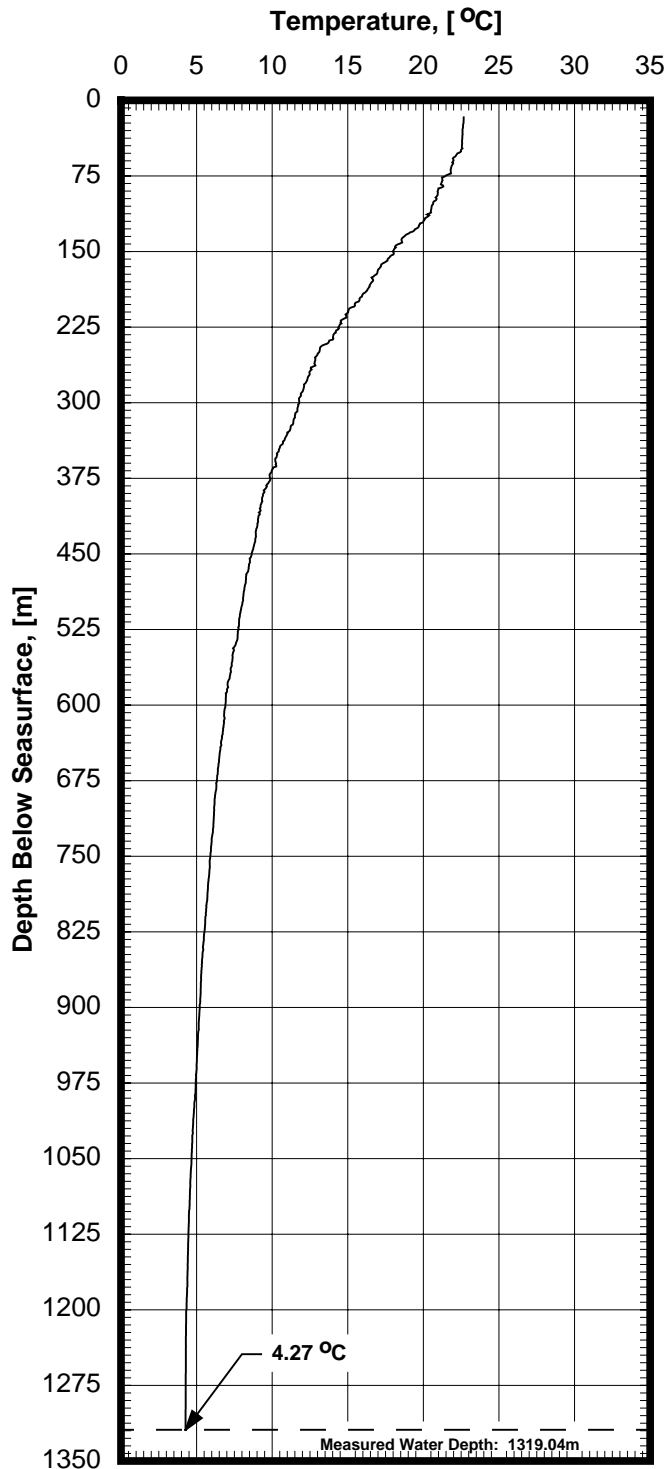

SEABIRD CTD DATA
 SEABIRD CTD Cast at KC151#3
 Well Location KC151#3
 CVX Gulf of Mexico Gas Hydrates JIP
 Block 151, Keathley Canyon Area, Gulf of Mexico

Date: _____
 Drawn By: _____
 Date: _____
 Date: _____
 Checked By: _____
 Approved By: _____

SECTION II
EVALUATION OF STATIC SOIL PROPERTIES

**EVALUATION OF STATIC SOIL PROPERTIES
CONTENTS**

	<u>Page</u>
EVALUATION OF STATIC SOIL PROPERTIES	II-1
Interpretation of Index and Physical Properties	II-1
Specific Gravity	II-2
Grain-Size Distribution	II-2
Index Properties	II-2
Degree of Saturation	II-4
Submerged Unit Weight	II-5
One-Dimensional Consolidation Tests	II-5
Static Shear Strength Parameters	II-7
Conventional Laboratory Strength Tests	II-7
SHANSEP Analysis for Shear Strength Interpretation	II-7
Remolded Shear Strength	II-8
Soil Sensitivity	II-8
TruePath™ K ₀ Consolidated-Undrained Triaxial Extension Tests	II-8
Hydraulic Conductivity Tests	II-9
SERVICE WARRANTY	II-10
REFERENCES	II-12

**EVALUATION OF STATIC SOIL PROPERTIES
ILLUSTRATIONS**

	<u>Plate</u>
Boring AT13#2,	
Water Content Data	II-1
Plasticity Chart	II-2
Plasticity Index Data.....	II-3
Liquidity Index Data.....	II-4
Degree of Saturation Data	II-5
Submerged Unit Weight Data	II-6
Interpreted Effective Vertical Stress Profile	II-7
Undrained Shear Strength Data.....	II-8
Normalized Peak Shear Strength Data.....	II-9
Remolded Shear Strength Data.....	II-10
Soil Sensitivity Data	II-11
Boring KC151#3,	
Water Content Data	II-12
Plasticity Chart	II-13
Plasticity Index Data.....	II-14
Liquidity Index Data.....	II-15
Degree of Saturation Data	II-16
Submerged Unit Weight Data	II-17
Interpreted Effective Vertical Stress Profile	II-18
Undrained Shear Strength Data.....	II-19
Normalized Peak Shear Strength Data.....	II-20
Remolded Shear Strength Data.....	II-21
Soil Sensitivity Data	II-22

EVALUATION OF STATIC SOIL PROPERTIES

The following sections discuss the laboratory test results of the laboratory program conducted onboard the vessel and post-cruise in our laboratory facility in Houston, Texas. Samples available for laboratory testing were limited to the two deep Borings AT13#2 and KC151#3.

The sampling and testing intervals employed during the geotechnical investigation were specified by the JIP scientific party. Continuous coring was conducted in those stratigraphic zones where gas hydrates were expected based on analysis of pre-cruise geophysical data and the corresponding LWD/MWD logging data. Samples tested by FMMG were obtained primarily obtained from the FHPC and FC samples, from the top ~45 mbsf (150-ft) in Borings AT13#2 and KC151#3, and from ~200 mbsf (656-ft) to ~380 mbsf (1,247-ft) in Boring KC151#3.

[Table I-5A](#) presented an overview of the samples from Boring AT13#2 that were made available to FMMG for offshore and onshore laboratory testing. A total of ten (10) FHPC samples (2.60-in.-ID, 3.00 m (10-ft) curatorial length) from the top ~45 m (150-ft) penetration of the boring were made available to FMMG for laboratory testing. This represents approximately 3.8 percent by curatorial length of the total length of sample material recovered from this boring, or 1.5 percent by absolute penetration of the boring.

[Table I-5B](#) presents an overview of those samples from Boring KC151#3 that were made available to FMMG for offshore and onshore laboratory testing. Thirteen (13) sub-sections cut from FHPC and FC cores were provided to FMMG, upon request, upon post-cruise processing of the samples at SCRIPPS laboratory in San Diego, California. Offshore laboratory testing was not performed on those samples.

A total of thirteen (13) FHPC samples (2.60-in.-ID, 3.17 m (10.4-ft) curatorial length), seven (7) FC samples (2.60-in.-ID, 1.37 m (4.5-ft) curatorial length), and one (1) HRC sample (2.00-in.-ID, 0.10 m (0.3-ft) curatorial length) from the top ~45 m (150 ft) and from 210 m (690-ft) to 390 m (1,280-ft) in Boring KC151#3 were available for the laboratory program. This represents approximately 5.0 percent by curatorial length of the total length of sample material recovered from this boring, or 1.1 percent by absolute penetration of the boring.

It should be noted that the amount of sample materials made available from the two (2) deep soil borings for the conventional and advanced laboratory testing program are insufficient to make reliable site-specific interpretation and recommendations. Laboratory test data, therefore, are presented without any interpretation or the derivation of data profiles of soil properties. To gain confidence in the data available and provide a more continuous profile of physical properties, an attempt was undertaken to integrate the different data sets (i.e., physical properties) developed by numerous JIP partners from the scientific community. A request was posted during the JIP post cruise meeting in November 2005, to have data made available for integration into FMMG's data plots. However, only the USGS Laboratory in Woodshole, Massachusetts, under supervision of Mr. W.J. Winters, made their data available to FMMG. Physical properties obtained from the USGS laboratory included physical property data from the various cores recovered from the AT13#2 and KC151#3 borings. The two sets of data (i.e., FMMG and USGS) were integrated to provide a comparison and gain confidence in the data sets.

Interpretation of Index and Physical Properties

The results of physical properties determined for samples from Boring AT13#2 and Boring KC151#3 are briefly discussed in the following paragraph. Seawater typically has a salt concentration of about 32 ppt (parts per thousand). The index and physical properties, i.e., water content, submerged unit weight, specific gravity and degree of saturation were not corrected for the effects of dissolved salts contained in the soil's pore fluid; salinity content was not measured by FMMG. However, the USGS data suggest that the amount of soluble salt content measured in the selected samples obtained from Borings

AT13#2 and KC151#3 ranges from about 32 ppt to 35 ppt. The observed levels of salinity measured in the samples are similar to the salinity content of seawater, typically measured at 32 ppt.

Specific Gravity. Specific gravity (G_s) tests were performed as part of the advanced laboratory testing program on six (6) samples from Boring AT13#2 and twelve (12) samples recovered from Boring KC151#3. The specific gravity is defined as the ratio of the unit weight of soil solids to the unit weight of fresh water. The G_s values for samples from Boring AT13#2 ranged from 2.734 to 2.780, while G_s values for samples from Boring KC151#3 ranged from 2.719 to 2.788, which is well within values commonly seen for these types of sediments (Lambe and Whitman, 1969). An average value of 2.750 has been used for calculating the degree of saturation and estimated submerged unit weight based on 100% saturation. The G_s values are tabulated in [Appendix B](#).

Grain-Size Distribution. The grain-size distribution of six (6) selected cohesive samples recovered from Boring AT13#2, and twelve (12) selected cohesive samples recovered from Boring KC151#3, were determined by hydrometer analyses, as part of the advanced laboratory testing program. The resulting grain-size distribution curves, which are presented in [Appendix B](#), were used as an aid to classify the samples. Results from the hydrometer analyses indicate that, in all of the tests, at least 98 percent of the material by weight passes the No. 200 sieve. Clay-sized fractions (less than 0.002 mm in diameter) is generally high and above 70 percent in the hydrometer tests, with the exception of a few samples that showed the presence of silt and silty fine sand pockets.

Index Properties. Water contents and Atterberg limits were obtained from soil samples recovered from the soil borings to provide information on physical properties and aid in soil classification.

The water contents (w), plastic limits (PL) and liquid limits (LL) are plotted on the boring logs (Plate [I-2](#) and [I-3](#)) and are tabulated in the Summary of Test Results in [Appendix B](#), with the exception of those tests associated with the advanced static testing program, which are tabulated in the summary tables of the corresponding advanced tests in [Appendix B](#).

Water Content. Water content data for Borings AT13#2 and KC151#3 are presented on Plates [II-1](#) and [II-12](#), respectively. The following is a summary of the trends observed for the water content values. Note that additional data obtained by the USGS Woodshole Laboratory are incorporated into the plates for the purpose of presentation and discussion.

Boring AT13#2 (Plate II-1): The water content of the soils decreases with depth. Water content data close to the seafloor and in the top 5 mbsf (15-ft) are between 62 and 72 percent, and are slightly decreasing with depth to about 50 percent at 45 mbsf (150-ft) penetration. [Plate II-1](#) also differentiates between conventional laboratory tests, primarily performed offshore, and those data obtained from the advanced laboratory tests, exclusively performed onshore in Fugro's laboratory in Houston, Texas. Also plotted are data sets provided by the USGS (Woodshole), which exhibit good agreement with FMMG's data set, indicating that good quality control with respect to water content testing was achieved in the field. The concurrence between the FMMG and USGS data sets, as well as field and laboratory water content results also suggests that sample integrity was maintained during packaging and shipping, and data confidence is high.

Boring KC151#3 (Plate II-12): Water content data are presented from mudline to 45 mbsf (150-ft) penetration on [Plate II-12a](#), and from 200 mbsf (656-ft) to 380 mbsf (1,247-ft) penetration on [Plate II-12b](#). Water content data in the top 45 mbsf are typical for deepwater Gulf of Mexico sites, generally high and above 80 percent in the top 5 mbsf (15-ft), and gradually decreasing over depth to approximately 30 percent at 45 mbsf (150-ft) penetration. Data from 200 mbsf (656-ft) to 380 mbsf (1,247-ft) show some degree of cyclicity with depth, in particular between 200 mbsf (656-ft) to approximately 280 mbsf (919-ft), where water content data vary between 30 percent and 40 percent.

Atterberg Limits. Atterberg limits for Borings AT13#2 and KC151#3 are plotted on the Plasticity Charts, Plates II-2 and II-13, respectively, where the plasticity index (PI) is plotted versus the liquid limit (LL), with the plasticity index defined as the difference between the liquid and plastic limit ($PI = LL - PL$). These plasticity charts are used to aid in the classification of cohesive soils. As can be seen from Plates II-2 and II-13, all the data fall within a narrow band, which is essentially parallel to, and above, the A-line. In general, such a trend indicates the soils are from the same or similar geologic origin. Plate II-2 further indicates that samples recovered from the top 45 mbsf in Boring AT13#2 are high plasticity clays (CH), while Plate II-13 shows those samples recovered from Boring KC151#3 being of medium to high plasticity (CH), with the exception of a few samples that show indications of non-organic and low plasticity clays (CL).

Plasticity Index Data. The plasticity index (PI) data for Borings AT13#2 and KC151#3 are presented on Plates II-3 and II-14, respectively. PI data associated with samples from Boring AT13#2 show a slight tendency to increase with depth, with values ranging from about 56 percent in the top 5 mbsf (15-ft) to about 64 percent at 45 mbsf (150-ft) penetration. PI data from Boring KC151#3 are gradually decreasing from about 60 percent near the mudline to about 35 percent at approximately 45 mbsf (150-ft) penetration. Some degree of cyclicity is also revealed in the PI values, where values between 200 mbsf (656-ft) and 220 mbsf (722-ft) and below 250 mbsf (820-ft) range between 44 and 60 percent, while values between 220 mbsf (722-ft) and 250 mbsf (820-ft) are significantly lower and range from 23 to about 34 percent. Data values that plot on the low plasticity (CL) side of the plasticity chart (Plate II-13) are associated with those values obtained on samples from about 220 mbsf (722-ft) to 250 mbsf (820-ft). These observations are consistent with those from water content data, as PI data generally would follow a trend similar to that of the water content data. However, typical trends generally seen in the deepwater environment of the Gulf of Mexico show a continuously decreasing trend with depth.

Liquidity Index Data. Calculated values of liquidity index (LI) data for Borings AT13#2 and KC151#3 are presented on Plates II-4 and II-15, respectively. The LI is an index property, which relates the natural water content (w) of a cohesive soil to its Atterberg limits, and is expressed by the following relationship:

$$LI = \frac{w - PL}{LL - PL} = \frac{w - PL}{PI}$$

Since the undrained shear strength of homogeneous saturated clay sediment is related to its water content, the LI provides an indication of the stress history of the formation. Shear strength trends can be predicted by observing the LI profile, and studies have shown that shear strength is inversely related to LI. In general, an LI of 1.0 or more is representative of very soft unconsolidated sediments, whereas a value close to zero is an indication of very stiff and/or overconsolidated material.

As indicated on Plates II-4 and II-15, the LI values for Borings AT13#2 and KC151#3 generally decrease gradually with depth from approximately 0.7 (1.0 for Boring KC151#3) in the top 5 mbsf (15-ft) penetration to about 0.5 at 45 mbsf (150-ft). Since LI generally decreases with depth, we would expect the shear strength profile to generally increase with depth. The trend changes in the PI profile are generally not revealed in the LI profiles due to corresponding changes in the water content of the clays.

The index and physical properties (such as natural water content, plasticity index and liquidity index) were also obtained on the specimens that were used for advanced static laboratory testing. As shown on Plates II-1 through II-4 for Boring AT13#2 and Plates II-12 through II-15 for Boring KC151#3, the index properties obtained from the specialized testing generally agreed well with the results obtained from the conventional laboratory testing, which indicates that good quality control was achieved in the field and in the laboratory. As mentioned earlier, the data below about 200 mbsf (656-ft) penetration in Boring KC151#3 show some degree of cyclicity, possibly, indicative of changing geologic origin or depositional environment.

Degree of Saturation. During any deepwater geotechnical investigation, a major source of sample disturbance is due to the large stress relief associated with removing a soil sample from a great depth below the sea level and bringing it to the surface. Due to this stress relief (i.e., reduction in hydrostatic pressure), there is a tendency for the sample to swell or expand because of the exsolution of dissolved gas in the pore fluids, or the expansion of free gas in the formation. When coring in formations bearing gas hydrates, gas expansion due to gas hydrate dissociation occurs during the sample recovery. A gas bubble of 1 mm diameter at 1000 m below the sea surface will expand to become a 4.5 mm diameter gas bubble at sea surface, an expansion factor of 100 folds (GEOTEK, 2005). An indication or measure of the degree of disturbance due to stress relief is provided by the degree of saturation of the soil sample (Whelan, 1979). Sample expansion results in a reduction in the degree of saturation in the samples and a decrease in the measured unit weight and UU triaxial shear strength. The degree of saturation (S_r) can be calculated using the following equation:

$$S_r = \frac{\gamma_t - \left[\frac{\gamma_t}{1+w} \right]}{\gamma_{w,\text{fresh}} \times \left[1 - \frac{\gamma_t}{\gamma_{w,\text{fresh}} \times G_s \times (1+w)} \right]}$$

where:

- γ_t = measured total unit weight;
- $\gamma_{w,\text{fresh}}$ = unit weight of fresh water;
- w = natural water content, decimal; and
- G_s = specific gravity adopted from laboratory test results (2.750).

For simplicity, the above equation considers the salt particles in seawater as solids within the total volume of soil sample. This assumption is conservative, since correcting the computed degree of saturation for salt content in the pore fluid (seawater) would lead to slightly higher values. The computed degree of saturation (S_r) data as a function of penetration is presented on Plates II-5 and II-16 for Borings AT13#2 and KC151#3, respectively. The following paragraphs briefly summarize the trends and implications.

Boring AT13#2 (Plate II-5): A clear difference is visible between those values associated with the conventional testing program and those obtained as part of the advanced testing program in the top 45 mbsf (150-ft) penetration. While tests from the conventional testing program yield values as low as 88 percent, S_r values associated with the advanced laboratory testing program are generally high and above 95 percent. Better sub-sampling and testing procedures achieved during post-cruise testing onshore due to smaller sample sizes can explain the difference between those two data sets.

Boring KC151#3 (Plate II-16): Computed degree of saturation data are presented from mudline to 45 mbsf (150-ft) penetration on Plate II-16a, and from 200 mbsf (656-ft) to 380 mbsf (1,247-ft) penetration on Plate II-16b. The S_r values in the top 10 mbsf (33-ft) penetration are generally high (> 90 percent), and are decreasing with depth to approximately 80 percent at 45 mbsf (150-ft) penetration. At deeper penetrations, between 200 mbsf (656-ft) to 380 mbsf (1,247-ft) penetration, the degree of saturation is more erratic and as low as 88 percent.

The effect of sample expansion is believed to be the most significant contributor to the wide range of degree of saturation data presented. The significant expansion encountered during the coring operations in the field is also documented by the thirteen (13) X-rays taken on whole-core FHPC and FC samples post-cruise. Due to sample disturbance, some portions of the FHPC and FC samples were

considered unsuitable for the advanced laboratory testing. The effect of sample expansion on the measured total unit weights and strength test results are discussed in subsequent paragraphs.

Submerged Unit Weight. The total unit weights were determined during the field phase of the investigation for those samples available to FMMG. The density of seawater (assumed to be 10.06 kN/m³ or 64 pcf) was subtracted from the calculated total unit weight to obtain an estimate of the submerged unit weight of the sample. These unit weight measurements are plotted on the boring logs (Plates I-2 and I-3) for Borings AT13#2 and KC151#3, respectively. These data are also tabulated in the Summary of Test Results in Appendix B with the exception of those tests associated with the specialized laboratory testing program, which are tabulated in the summary of each specialized test in Appendix B.

As discussed earlier, sample expansion results in a decrease in the measured total unit weight of the sample and consequently a reduction in the degree of saturation. To further investigate the effect of sample expansion on the measured unit weights, submerged unit weight values were computed using natural water content and an assumed specific gravity of 2.75, with the assumption that the soils are 100 percent saturated in situ. The submerged unit weights were computed using the following equation:

$$\gamma' = \gamma_{w,\text{fresh}} \times \left[\frac{G_s \times (1 + w)}{1 + w \times G_s} \right] - \gamma_{w,\text{Sea}}$$

where:

- γ' = theoretical submerged unit weight;
- $\gamma_{w,\text{fresh}}$ = unit weight of fresh water;
- $\gamma_{w,\text{Sea}}$ = unit weight of sea water;
- w = natural water content, decimal; and
- G_s = specific gravity (assumed 2.75).

The measured and computed unit weight values along with the 'gamma density' measurements from GEOTEK's Multi Sensor Core Logger (MSCL) are plotted on Plates II-6 and II-17 for Borings AT13#2 and KC151#3, respectively, and on the boring logs, Plates I-2 and I-3. Also plotted on these plates are the unit weight values measured on additional samples by the USGS Woodshole laboratory. Measured and theoretical values of submerged unit weight values correlate well within limits, which generally suggests that sample expansion was minor. The MSCL data show excellent agreement with the corresponding measured and theoretical values of submerged unit weight in Boring AT13#2, giving high confidence in all data sets presented on Plate II-6. Values presented on Plate II-17a for Boring KC151#3 show somewhat more scatter, especially the USGS data are higher than FMMG's measured values, and those obtained from MSCL measurements in the top 45 mbsf (150-ft) penetration.

One-Dimensional Consolidation Tests. Two (2) samples from Boring AT13#2 and ten (10) samples from Boring KC151#3 were selected and used to perform controlled-rate-of-strain (CRS) one-dimensional consolidation tests. The maximum past stresses ($\sigma'_{v,m}$) were determined using the classical Casagrande Method (Casagrande, 1936) and the Work per Unit Volume Method proposed by Becker et al. (1987). The results are plotted on Plates II-7 and II-18 for Borings AT13#2 and KC151#3, respectively. For purpose of presentation and discussion only, an effective overburden pressure ($\sigma'_{v,\text{sub}}$) profile based on a constant submerged unit weight assumed to 6.0 kN/m³ (38 pcf) is plotted together with the results from the CRS tests. The effective overburden pressure profile on Plates II-7 and II-18 are solely for the purpose of discussion and presentation and should not be used for any other purpose unless specified herein.

The stress history of a formation is defined by the overconsolidation ratio (OCR), which is the ratio of the effective maximum past stress to the present effective overburden pressure. Based on a comparison of the effective overburden stresses to the estimated effective maximum past stresses, it is suggested that

clays in both locations (AT13#2 and KC151#3) are in a state of under-consolidation. Values of the maximum past stresses ($\sigma'_{v,m}$) show significant variations when using either the classical Casagrande Method (Casagrande, 1936) or the Work per Unit Volume Method proposed by Becker et al. (1987), with the last mentioned generally yielding the higher side.

Permeability and coefficient of consolidation (C_v) data from the CRS test are presented in [Appendix C](#) along with the consolidation curves for the tests performed.

Sample Quality Assessment. Various approaches to assess the sample quality have been taken and described in the previous paragraphs. A common method for evaluating sample disturbance is based on the assessment of the amount of the volumetric strain change that a sample undergoes during the re-consolidation to its in situ effective pressure (or pre-consolidation pressure, whichever is smaller), during a one-dimensional consolidation test. During CRS test, a sample must undergo less than 2 percent volumetric strain change when consolidated to the in situ stress condition to be undisturbed (Andresen and Kohlsted, 1979). Therzaghi (1996) and Lunne et al. (1997) both developed quantitative assessment criteria to categorize sample disturbance. Therzaghi's approach utilizes the volumetric strain (ϵ_{vol}) that a sample undergoes during the re-consolidation phase to categorize the sample quality ranging from grade "A" representing very good quality with less than 1 percent volumetric strain, to grade "E" representing very poor sample quality with more than 10 percent volumetric strain. Lunne et al. uses the change in void ratio over initial void ratio ($\Delta e/e_0$) to assess sample quality. Furthermore, Lunne et al. incorporated the overconsolidation ratio in their analysis to account for sample susceptibility to disturbance due to varying stress states. [Table II-1](#) and [Table II-2](#) below present the criteria developed by Therzaghi and Lunne et al., respectively, to assess sample quality.

Table II-1 – Therzaghis' Criteria to Evaluate Sample Disturbance using ϵ_{vol}

Volumetric Strain	< 1%	1 – 2%	2 – 4%	4 – 10%	> 10%
Sample Quality	A	B	C	D	E
	<i>very good</i>			→	<i>extremely poor</i>

Table II-2 – Lunne's Criteria to Evaluate Sample Disturbance using $\Delta e/e_0$

Sample Quality		<i>very good to excellent</i>	<i>good to fair</i>	<i>poor</i>	<i>very poor</i>
OCR	1 – 2	< 0.04	0.04 - 0.07	0.07 - 0.14	> 0.14
	2 - 4	< 0.03	0.03 - 0.05	0.05 - 0.10	> 0.10

Using the above criteria to assess sample disturbance effects for the two (2) CRS tests conducted in Boring AT13#2, the samples are indicated to be of poor (D) to very poor (E) quality. The volumetric strain calculated for samples from Boring AT13#2 ranges from 3.82 percent to 6.28 percent, while the change in void ratio is estimated to be 0.06 to 0.10, depending on the pre-consolidation pressure utilized for either assessment (i.e., Casagrande vs. Becker).

Sample quality determined from the ten (10) CRS tests conducted on samples from Boring KC151#3 falls within a somewhat broader range. The volumetric strain calculated for those samples ranges from 3.37 to 12.11 percent and the change in void ratio is estimated between 0.07 and 0.22. Sample quality determined from the CRS tests conducted in Boring KC151#3 suggests also poor (D) to very poor (E) quality.

Static Shear Strength Parameters

In this investigation, the undrained shear strengths of the clays were evaluated by conventional laboratory strength tests (Miniature vane shear and UU triaxial compression tests), and specialized laboratory tests (direct simple shear tests).

Conventional Laboratory Strength Tests. Standard strength tests were performed on 2.6-in.-diameter FHPC and FC samples immediately after recovery from the borings and MSCL logging. Miniature vane (MV), unconsolidated-undrained (UU) triaxial compression, Torvane (TV) and pocket penetrometer (PP) tests were performed to evaluate soil shear strength in the field and onshore. Results of the conventional laboratory strength tests are presented on the Logs of Boring and Test Results (Plates I-2 and I-3) for Boring AT13#2 and KC151#3, respectively.

Undrained shear strength data from MV and UU triaxial compression tests are typically used as the basis for shear strength interpretation. Quiros et al. (1983) reported that MV and UU triaxial shear strength measurements agree very well in soils that do not exhibit expansive behavior. Significant sample expansion, as previously discussed, has been observed in the field and has caused significant disturbance to the samples. Although good agreement between various data sets of submerged unit weight measurements and/or estimates has been observed (Plates II-6 and II-17), and might suggest that sample expansion was only limited, analysis of CRS tests indicate that significant disturbance occurred throughout the un-pressurized coring intervals.

SHANSEP Analysis for Shear Strength Interpretation. To better assess the remote vane shear and the conventional strength test results relative to in situ conditions, K_o -consolidated, static, strain-controlled direct simple shear (CK_oU' -DSS) tests were performed. The SHANSEP (Stress History And Normalized Soil Engineering Properties) approach proposed by Ladd and Foott (1974) was utilized to determine the undrained shear strength of the soil corresponding to a direct simple shear mode of failure. This approach requires reliable determination of the in situ stress history and is restricted to clays exhibiting normalized behavior, thus excluding naturally cemented and highly sensitive clay deposits.

The SHANSEP undrained shear strength interpretation involves three stages. The first step is to establish the stress history of the clay from the laboratory one-dimensional consolidation (CRS) tests. Then, representative K_o -consolidated, static, strain-controlled direct simple shear (CK_oU' -DSS) tests are performed to determine the normalized soil parameters. Third, providing normalized behavior is observed, undrained shear strength estimates for normally to overconsolidated clays may be calculated using the equation below, proposed by Ladd et al. (1977):

$$S_u = \left(\frac{c_u}{\sigma'_{v,c}} \right)_{nc} \times \sigma'_{v,sub} \times (OCR)^{0.8}$$

where:

$\left(\frac{c_u}{\sigma'_{v,c}} \right)_{nc}$	=	normalized shear strength ratio obtained from CK_oU' -DSS tests, often called the c/p-ratio;
$\sigma'_{v,c}$	=	effective vertical consolidation pressure in CK_oU' -DSS tests;
$\sigma'_{v,sub}$	=	effective hydrostatic overburden stress; and
OCR	=	overconsolidation ratio (≥ 1.0)

Prior to shearing, CK_oU' -DSS test specimens to be used with the SHANSEP approach were consolidated to about 1.5 to 3.0 times the laboratory measured maximum past stress ($\sigma'_{v,m}$). This testing

procedure was intended to reduce the effects of sample disturbance that occur during soil sampling and specimen preparation by inducing a normally consolidated state of stress ($OCR = 1.0$) with respect to the past consolidation stress. Difficulties to determine the laboratory measured maximum past stresses for the CRS tests on samples from Boring AT13#2 and KC151#3 were discussed previously. Upon completion of consolidation, the specimens were sheared under constant volume conditions (undrained) at a shear strain rate of about five percent per hour.

A total of two (2) K_0 -consolidated, static, strain-controlled direct simple shear (CK_0U -DSS) tests for Boring AT13#2 and nine (9) tests for Boring KC151#3 were carried out to characterize the behavior of the soils encountered. These tests were performed according to the SHANSEP approach at an induced overconsolidation ratio (OCR) of one. The normalized peak shear strength data ($c_u/\sigma'_{v,c}$) versus depth are plotted on Plates II-9 and II-20 for Borings AT13#2 and KC151#3, respectively, and are also summarized in Appendix B.

The DSS Shear strengths computed in accordance with the above SHANSEP equation are several times higher than the undrained shear strengths measured in the laboratory on recovered samples and it appears that the normalized peak shear strength data (Plates II-9 and II-20) are within the range commonly seen in the deepwater environment of the Gulf of Mexico for c/p -ratios in the range of 0.20 to 0.35. This leads to the conclusion that introducing a normally consolidated stress state with respect to the past consolidation stress to the DSS test samples seems to reduce the effects of sample disturbance to some degree, although the poor quality of CRS test data and respective measured maximum past stresses affect the DSS shear strength computed in accordance with the SHANSEP equation.

Remolded Shear Strength

Knowledge of the remolded shear strength and its variation with depth is an important design parameter for computing self weight penetration of piles, conductors, and casings. In this case, it is useful to once again assess the data quality of the undisturbed conventional laboratory tests. Results of remolded miniature vane shear tests performed on samples from Borings AT13#2 and KC 151#3 are shown on the boring logs, Plates I-2 and I-3, and on Plates II-10 and II-21, respectively.

Soil Sensitivity

Soil sensitivity is defined as the ratio of peak undrained shear strength to remolded undrained shear strength, without change in water content (Lambe and Whitman, 1969). In this study, only miniature vane shear strengths were used to evaluate soil sensitivity. Soil sensitivity data are presented on Plates II-11 and II-22 for Borings AT13#2 and KC151#3, respectively.

The majority of the measured soil sensitivity data obtained for samples from the top 45 mbsf (150-ft) penetration in Borings AT13#2 and KC151#3 fluctuate between 0.4 and 3.8. Soil sensitivity data measured on samples recovered from 200 mbsf (686-ft) to 380 mbsf (1,247-ft) penetration in Boring KC151#3 are consistently lower than 2.0, indicating that the samples are significantly disturbed and, thus, the calculated soil sensitivity values may not be representative.

TruePath™ K_0 Consolidated-Undrained Triaxial Extension Tests

A total of four (4) static TruePath™ K_0 consolidated-undrained triaxial extension tests (TPK₀U-TE) with pore-water pressure (PWP) measurements and strain-controlled loading were conducted as part of the advanced laboratory testing program. Two (2) samples from Boring AT13#2, from depths of 23.59 mbsf (77.4-ft) and 41.30 mbsf (135.5-ft), and two (2) samples from Boring KC151#3, from depths of 216.62 mbsf (710.7-ft) and 258.99 mbsf (849.7-ft), were selected for the triaxial extensions tests, in order to determine the K_0 consolidation and undrained shear parameters. A table summarizing selected physical properties, consolidation and shearing parameters and stress-strain properties for the four (4) TPK₀U-TE tests is

presented in [Appendix B](#). Also presented in [Appendix B](#) are the testing procedures employed and the individual test results.

Hydraulic Conductivity Tests

A total of four (4) hydraulic conductivity (permeability) test (S₂-CI-HC-VHR) series with multiple consolidation stages were conducted as part of the advanced laboratory testing program. A test series commonly consists of three individual tests with the specimen orientation being representative of vertical, horizontal, or remolded conditions. One sample from Boring AT13#2 from a depth of 8.14 mbsf (26.7-ft), and three (3) samples obtained from Boring KC151#3 from depths of 44.11 mbsf (144.7-ft), 100.78 mbsf (35.4-ft), and 243.66 mbsf (799.4-ft) were used to determine the hydraulic conductivity, *k*, and to assess how *k* is affected by direction of flow and remolding. A table summarizing selected physical properties, permeability and change of permeability with change of flow direction or sample condition is presented in [Appendix B](#). Also presented in [Appendix B](#) are the testing procedures employed and the individual test results.

SERVICE WARRANTY

This section entitled "Service Warranty" outlines the limitations and constraints of this report in terms of a range of considerations including, but not limited to, its purpose, its scope, the data on which it is based, its use by third parties, possible future changes in design procedures and possible changes in the conditions at the site with time. This section represents a clear description of the constraints, which apply to all reports issued by FMMG. It should be noted that the Service Warranty does not in any way supersede the terms and conditions of the contract between FMMG and the Client.

1. This report and the assessment carried out in connection with the report (together the "Services") were compiled and carried out by Fugro-McClelland Marine Geosciences, Inc. (FMMG) for the Client in accordance with the terms of the Contract. Further, and in particular, the Services were performed by FMMG taking into account the limits of the scope of works required by the Client, the time scale involved, and the resources, including financial and manpower resources, agreed between FMMG and the Client. FMMG has not performed any observations, investigations, studies, or testing not specifically set out or required by the Contract between the Client and FMMG.
2. The Services were performed by FMMG exclusively for the purposes of the Client, and Client warrants that this report will not be transferred or conveyed to any other persons or entities for any reason, with the sole exception of classification societies or other regulatory agencies necessary for Client's purposes. Should this report or any part of this report, or details of the Services or any part of the Services be made known to any such other person or entity not authorized herein, and such person or entity relies thereon, that party does so wholly at its own and sole risk and FMMG disclaims any liability to such party.
3. It is FMMG's understanding that this report is to be used for the purpose described in the report. That purpose was a significant factor in determining the scope and level of the Services. Should the purpose for which the report is used, and/or should the Client's proposed development or use of the site change (including in particular any change in any design and/or specification relating to the proposed use or development of the site), this report may no longer be valid or appropriate and any further use of, or reliance upon, the report in those circumstances by the Client without FMMG's review and advice shall be at the Client's sole and own risk. Should FMMG be requested, and FMMG agree, to review the report after the date hereof, FMMG shall be entitled to additional payment at the then existing rates or such other terms as may be agreed between FMMG and Client.
4. The passage of time may result in changes (whether man-made or otherwise) in site conditions and changes in regulatory or other legal provisions, technology, methods of analysis, or economic conditions, which could render the information and results presented in the report inaccurate or unreliable. The information, recommendations, and conclusions contained in this report should not be relied upon if any such changes have taken place, without the written agreement of FMMG. In the absence of such written agreement of FMMG, reliance on the report after any such changes have occurred shall be at the Client's own and sole risk. Should FMMG agree to review the report after such changes have taken place, FMMG shall be entitled to additional payment at the then existing rates or such other terms as may be agreed between FMMG and the Client.
5. Where the Services have involved FMMG's interpretation and/or other use of any information (including documentation or materials, analyses, recommendations and conclusions) provided by third parties (including independent testing and/or information, services or laboratories) or the Client and upon which FMMG was reasonably entitled to rely or involved FMMG's observations of existing physical conditions of any site involved in the Services, then the Services clearly are

limited by the accuracy of such information and the observations which were reasonably possible of the said site. Unless otherwise stated, FMMG was not authorized and did not attempt to independently verify the accuracy or completeness of such information, received from the Client or third parties during the performance of the Services. FMMG is not liable for any inaccuracies (including any incompleteness) in the said information, save as otherwise provided in the terms of the contract between the Client and FMMG.

6. The soil and ground conditions information provided in the Services are based solely on evaluations of the soil and ground condition samples (and in situ tests if applicable) at determined sample test locations and elevations. That information cannot be extrapolated to any area or elevation outside those locations and elevations unless specifically so stated in the report. In the light of the information available to FMMG, the soil and ground conditions information is considered appropriate for use in relation to the geotechnical design and installation aspects of the structures addressed in the report, but they may not be appropriate for the design of other structures.

REFERENCES

- American Society for Testing and Materials (2004), "Soil and Rock; Dimension Stone; Geosynthetics", Annual Book of ASTM Standards, Vol. 4.08, ASTM, Philadelphia.
- Becker, D.E., Crooks, J.H.A., Been, K., and Jefferies, M.G. (1987), "Work as a Criterion for Determining In situ and Yield Stresses in Clays", Canadian Geotechnical Journal, Vol. 24., pp. 549-564.
- Casagrande, A. (1936), "The Determination of the Preconsolidation Load and Its Practical Significance", Proceedings of the First International Conference on Soil Mechanics and Foundation Engineering, Cambridge, Vol. III, pp. 60-64.
- Claypool (2005), Various Internet Sources, i.e., <http://www.netl.doe.gov>, keyword: Gas Hydrates JIP
- Integrated Ocean Drilling Program - IODP (2004), Advanced Piston Corer Temperature (APCT) Tool Manual, IODP, Texas A&M University, College Station, Texas
- Ladd, C.C. and Foott, R. (1974), "New Design Procedures for Stability of Soft Clays", Journal, Geotechnical Engineering Division, ASCE, Vol. 100, No. GT7, pp. 763-786.
- Ladd, C.C., Foott, R., Ishihara, K., Schlosser, F., and Poulos, H.G. (1977), "Stress-Deformation and Strength Characteristics", Proceedings of the Ninth International Conference on Soil Mechanics and Foundation Engineering, Tokyo, Vol. 2, pp. 421-494.
- Lambe, T.W. and Whitman, R.V. (1969), Soil Mechanics, John Wiley & Sons, Inc., New York, p. 448.
- Lunne, T., Berre, T. Strandvik, S. (1997), "Sample Disturbance Effects in Soft Low Plasticity Norwegian Clay", Proceedings of Conference on Recent Development in Soil and Pavement Techniques, Rio de Janeiro, pp. 81-102.
- Quiros, G.W., Young, A.G, Pelletier, J.H., and Chan, J.H-C. (1983), "Shear Strength Interpretation of Gulf of Mexico Clays," Geotechnical Practice in Offshore Engineering, ASCE Conference, Austin, Texas, April 27-29, 1983, pp. 144-165.
- GEOTEK, Ltd. (2005), Characterizing Natural Gas Hydrates in the Deep Water Gulf of Mexico: Application for Safe Drilling and Production Activities, GEOTEK Report for *Gulf of Mexico Gas Hydrates Joint Industry Project*.
- Soderberg, L.O. (1962), "Consolidation Theory Applied to Foundation Pile Time Effects," Geotechnique, Vol. 12, pp.217-225
- Therzaghi, K., Peck, R.B., Mesri, G. (1996), Soil Mechanics in Engineering Practice, John Wiley and Sons, Inc. New York.
- Whelan, T. (1979), "Methane in Marine Sediments", Lectures Notes for Technical Session Presented to McClelland Engineers, Inc., Houston.

SECTION II
ILLUSTRATIONS

Water Content, [%]

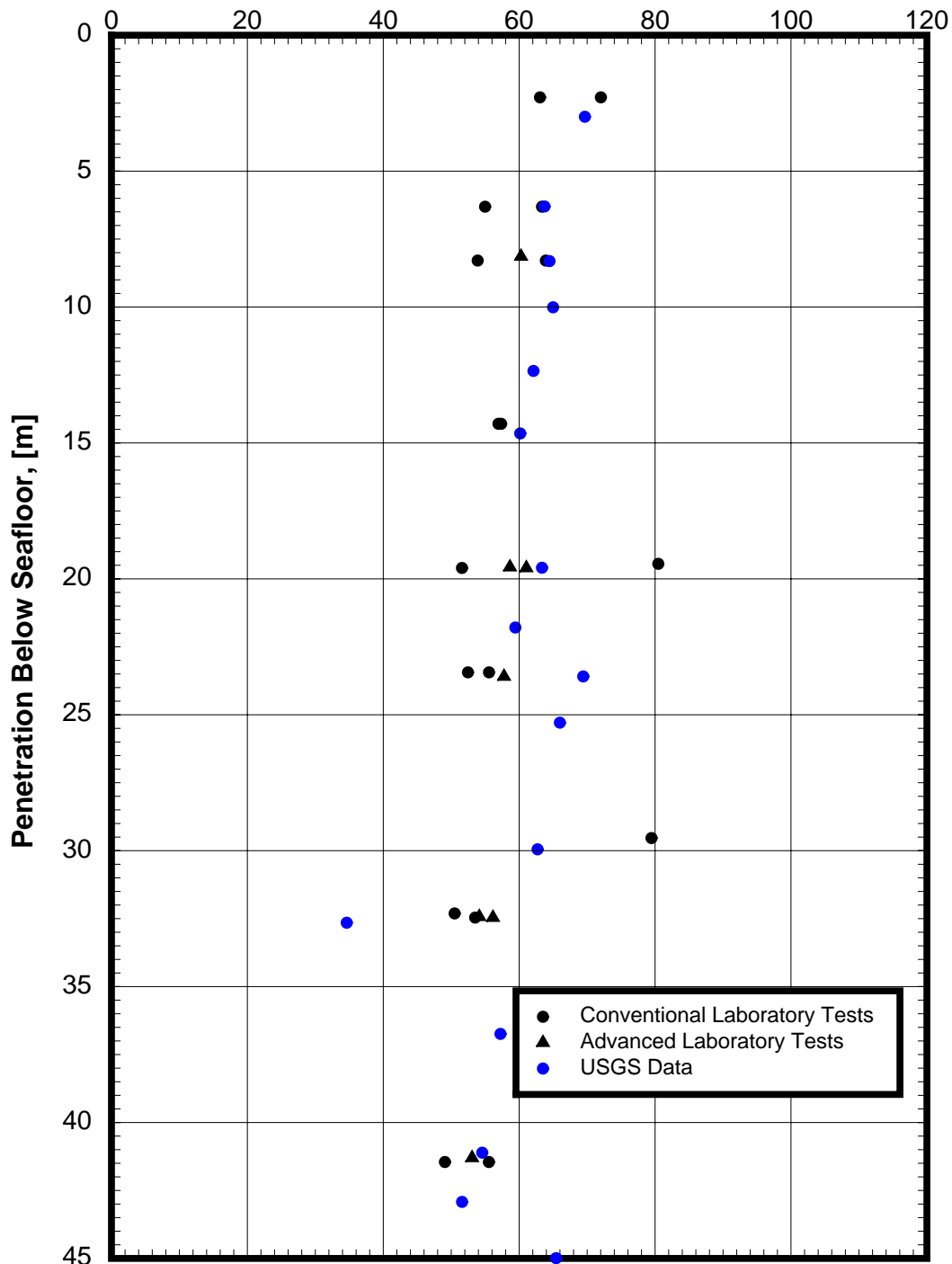

WATER CONTENT DATA
 Boring AT13#2
 CVX Gulf of Mexico Gas Hydrates JIP
 Block 13, Atwater Valley Area, Gulf of Mexico

Date:

Drawn By:

Date:

Date:

Checked By:

Approved By:

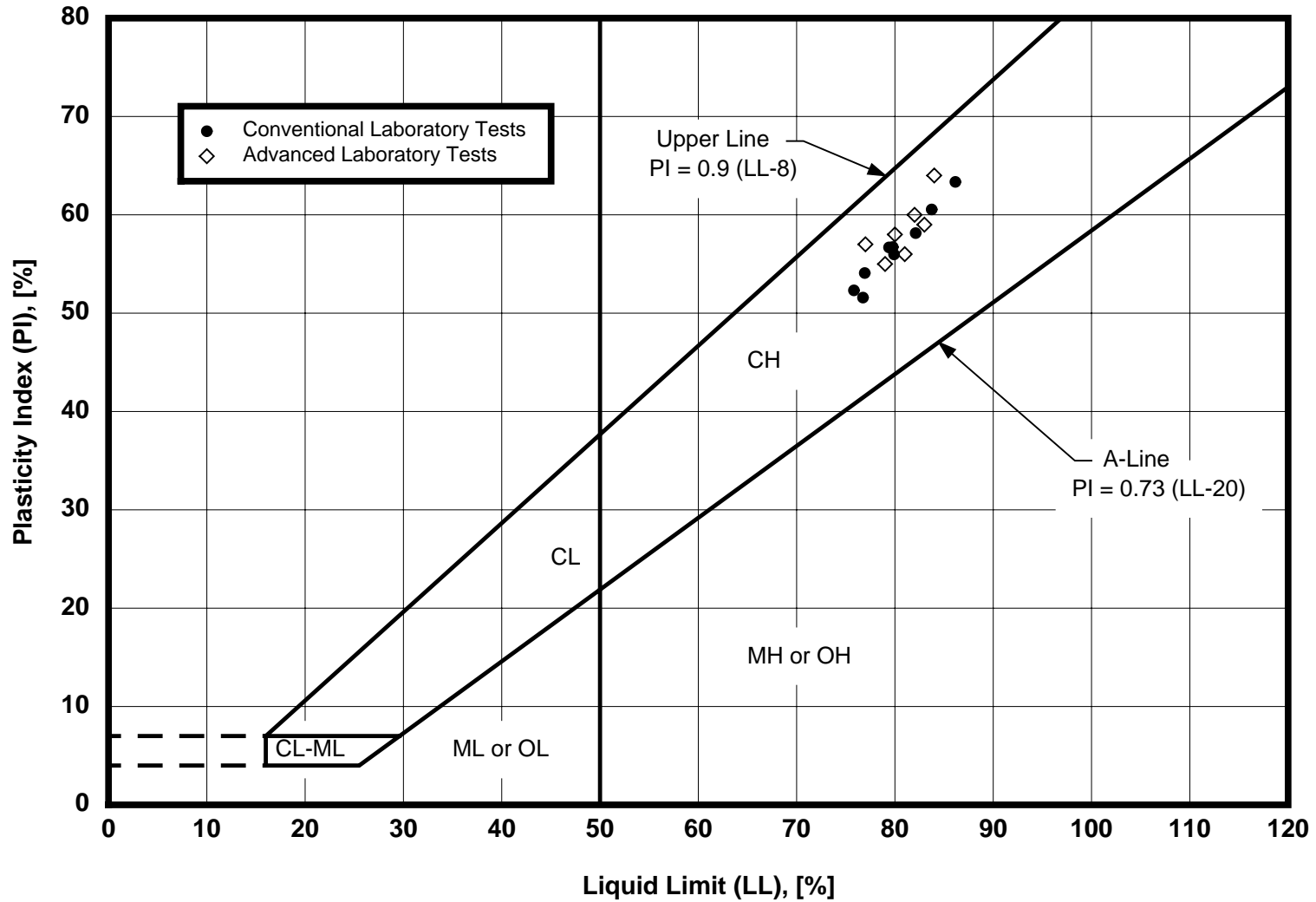

PLASTICITY CHART

Boring AT13#2
CVX Gulf of Mexico Gas Hydrates JIP
Block 13, Atwater Valley Area, Gulf of Mexico

Plasticity Index (PI), [%]

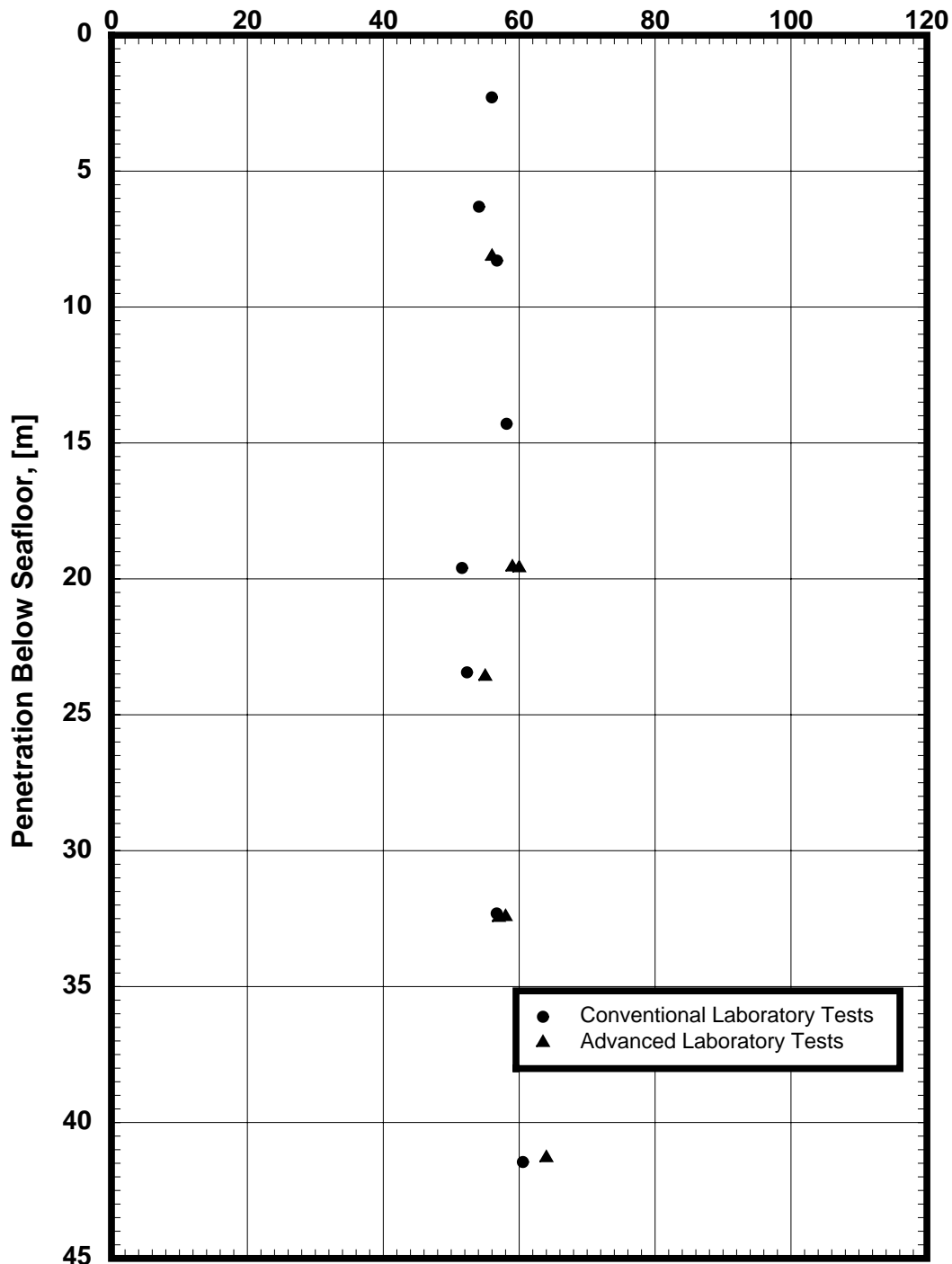

PLASTICITY INDEX DATA
 Boring AT13#2
 CVX Gulf of Mexico Gas Hydrates JIP
 Block 13, Atwater Valley Area, Gulf of Mexico

Date:

Drawn By:

Date:

Date:

Checked By:

Approved By:

Liquidity Index (LI)

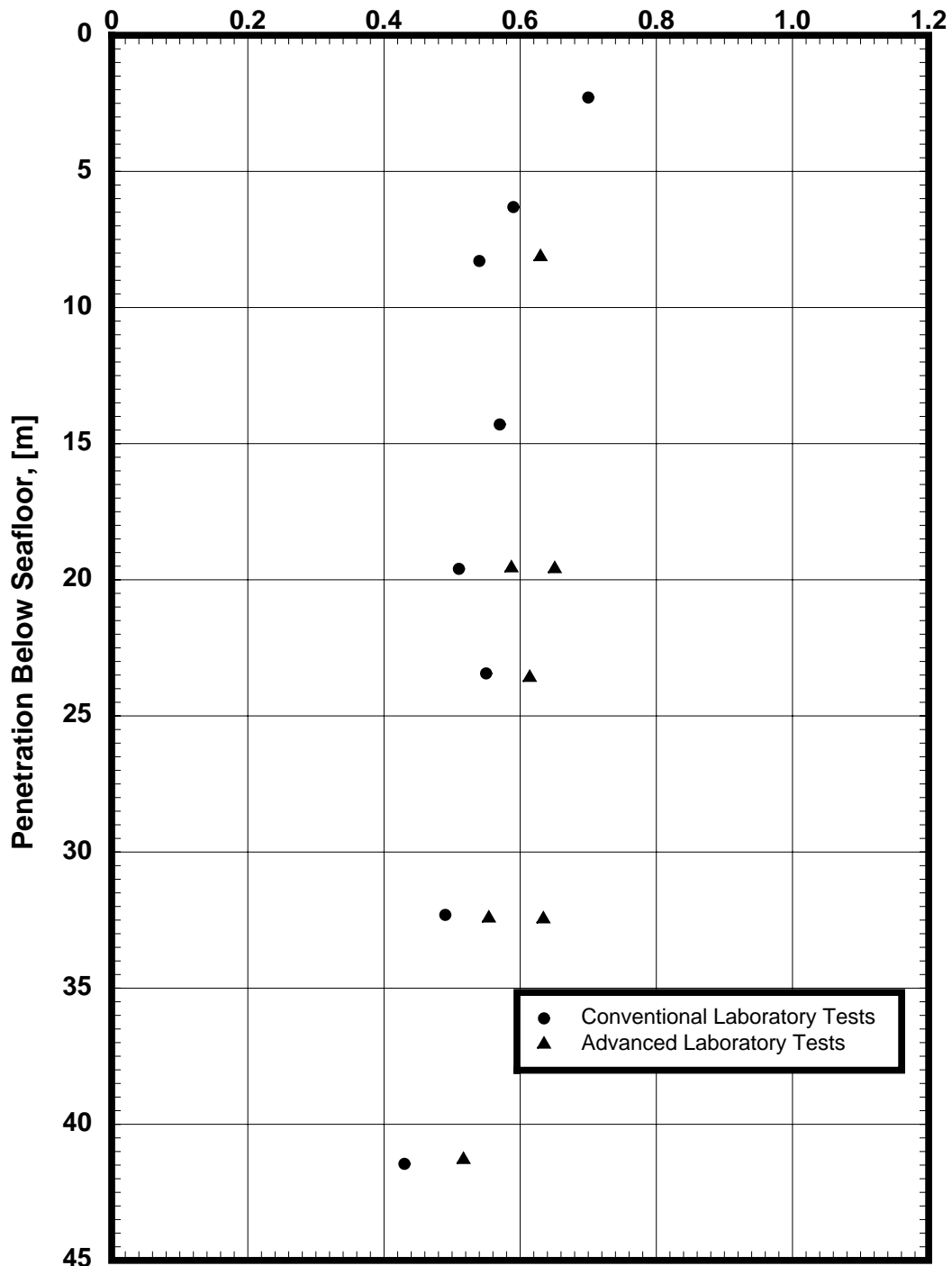

LIQUIDITY INDEX DATA

Boring AT13#2

CVX Gulf of Mexico Gas Hydrates JIP

Block 13, Atwater Valley Area, Gulf of Mexico

Date:

Drawn By:

Date:

Date:

Checked By:

Approved By:

Degree of Saturation, [%]

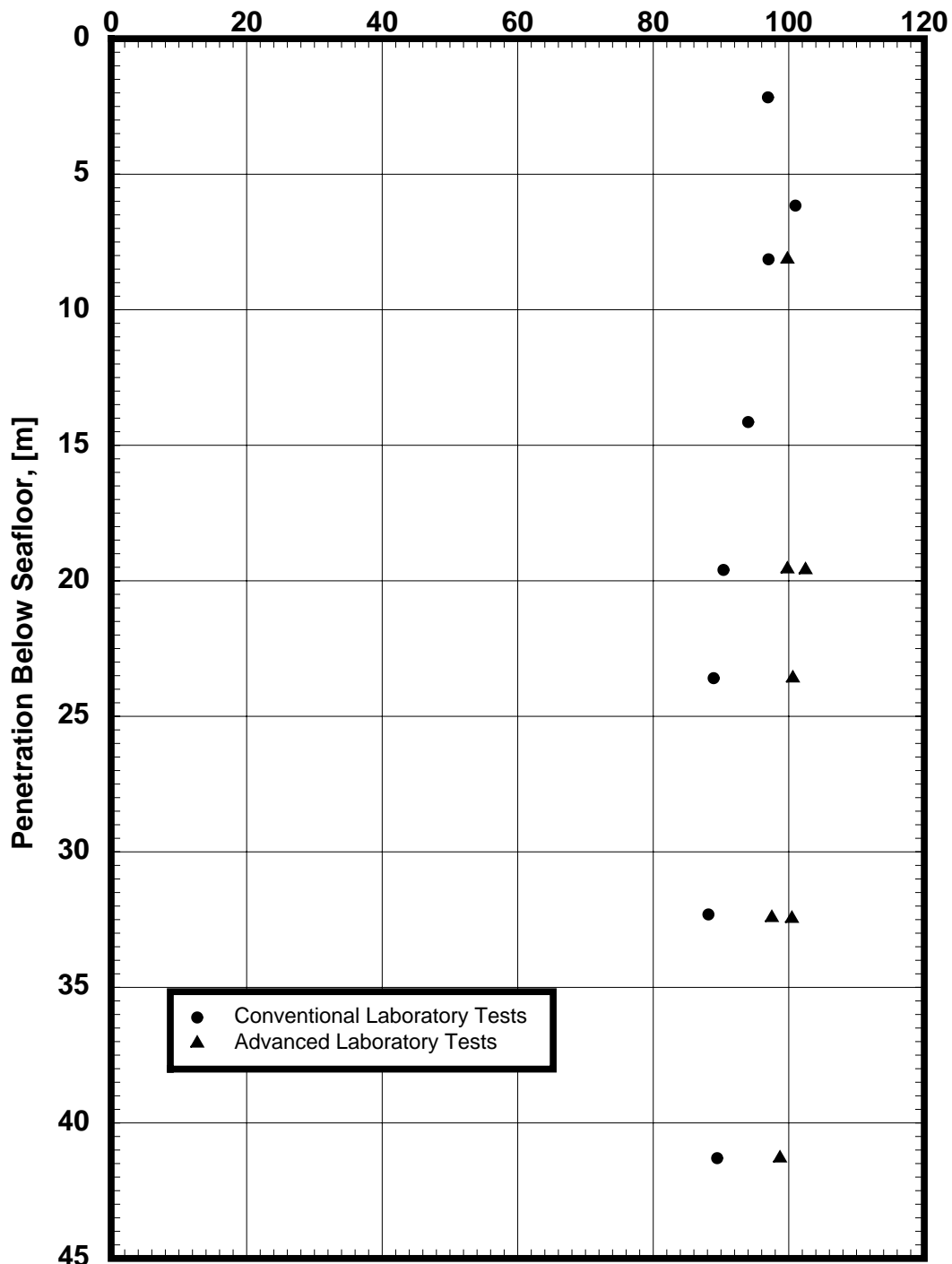

DEGREE OF SATURATION DATA
 Boring AT13#2
 CVX Gulf of Mexico Gas Hydrates JIP
 Block 13, Atwater Valley Area, Gulf of Mexico

Date:

Drawn By:

Date:

Date:

Checked By:

Approved By:

Submerged Unit Weight, [kN/m³]

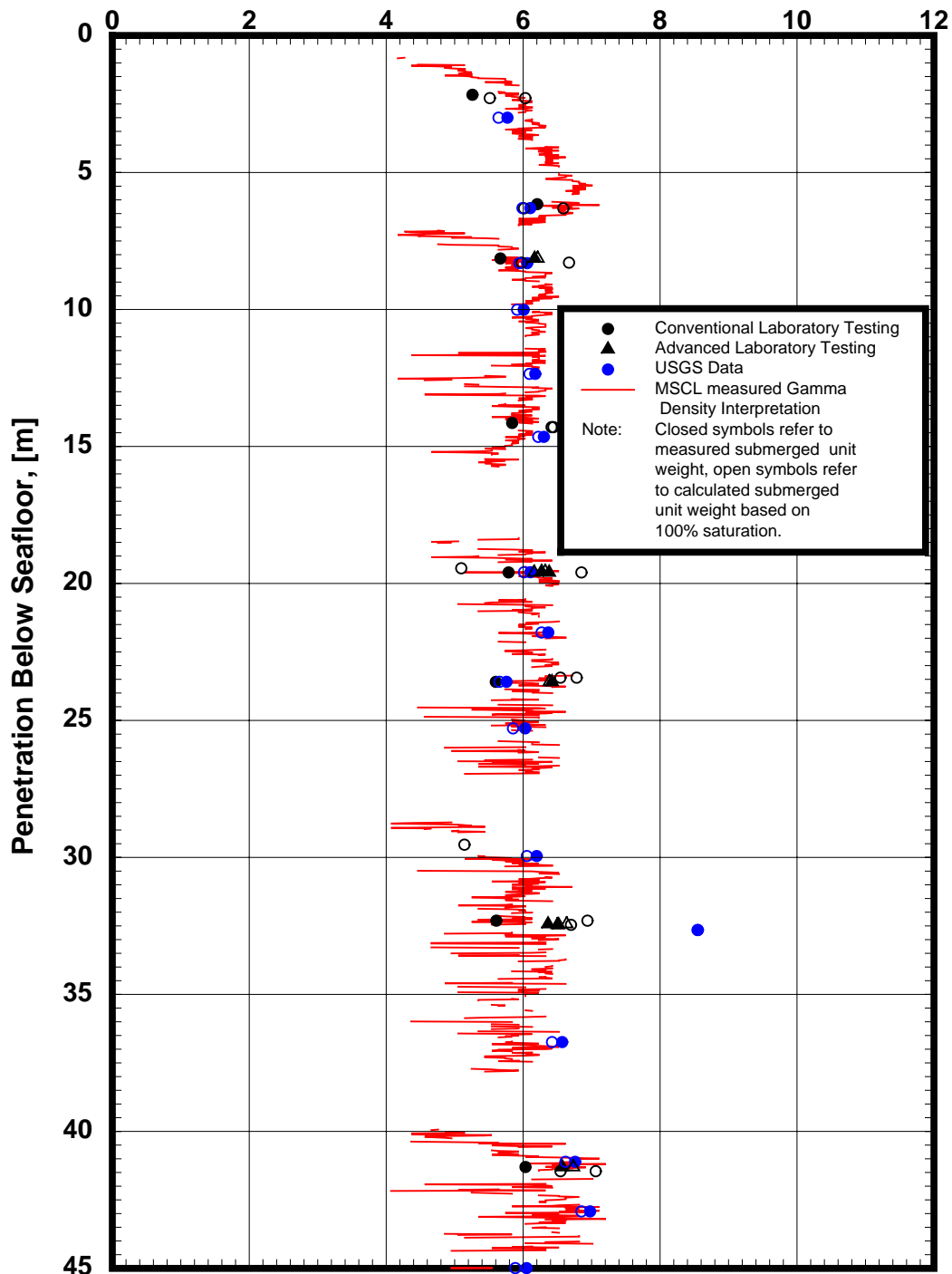

SUBMERGED UNIT WEIGHT DATA
 Boring AT13#2
 CVX Gulf of Mexico Gas Hydrates JIP
 Block 13, Atwater Valley Area, Gulf of Mexico

Date: _____
 Drawn By: _____
 Date: _____
 Date: _____
 Checked By: _____
 Approved By: _____

Effective Vertical Stress, [kPa]

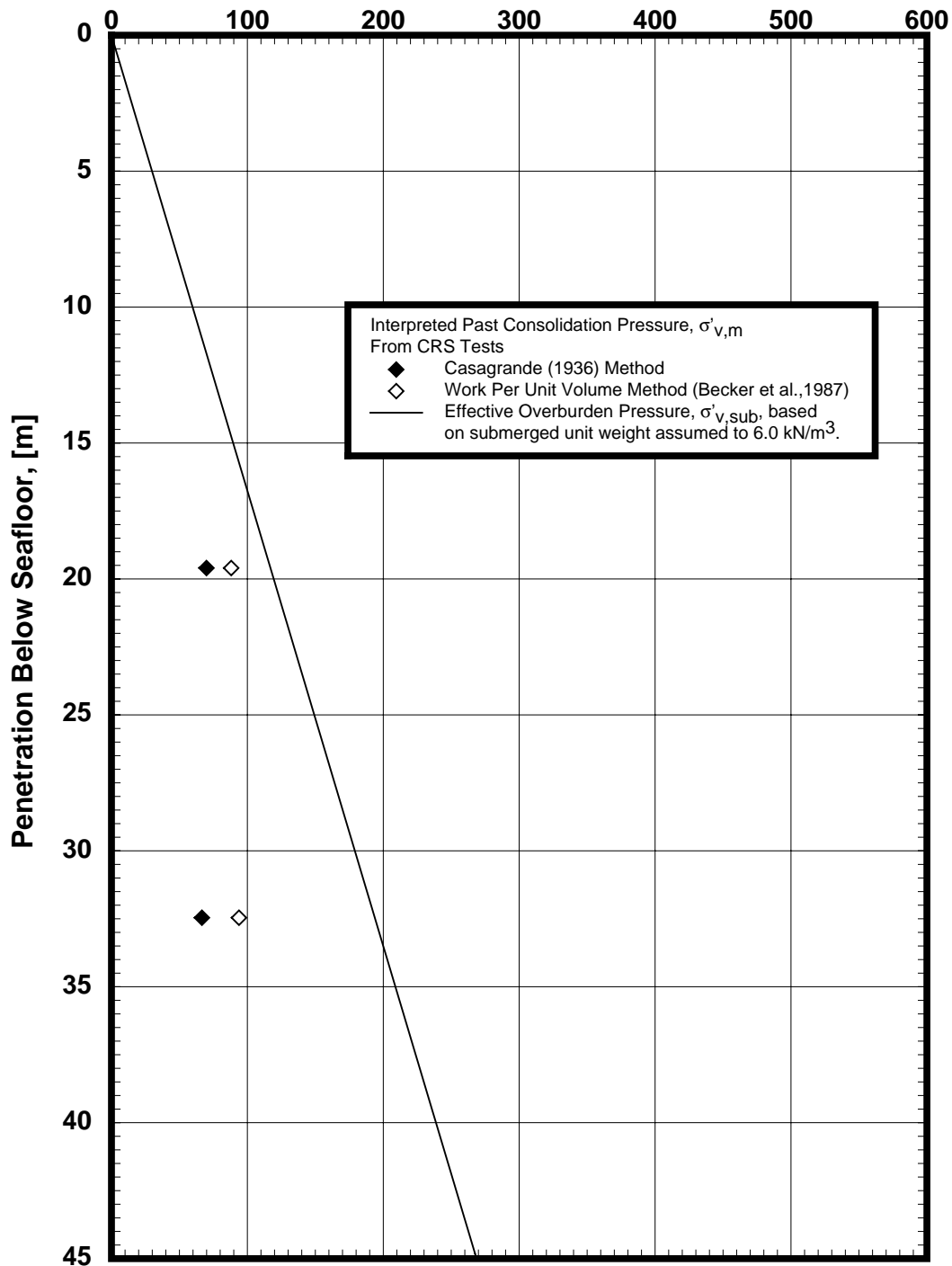

INTERPRETED EFFECTIVE VERTICAL STRESS PROFILE

Boring AT13#2

CVX Gulf of Mexico Gas Hydrates JIP

Block 13, Atwater Valley Area, Gulf of Mexico

Date:

Drawn By:

Date:

Date:

Checked By:

Approved By:

Undrained Shear Strength, [kPa]

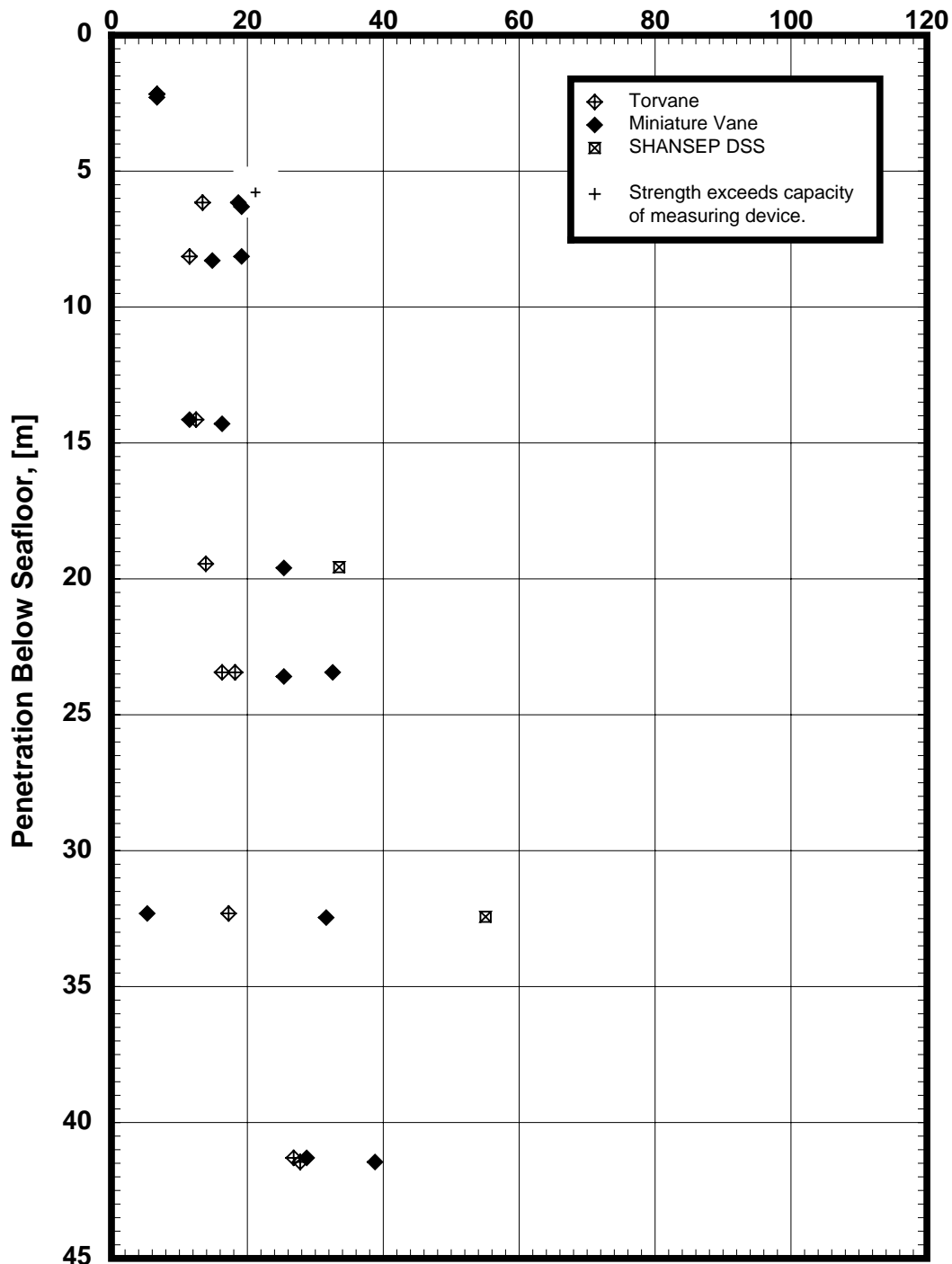

UNIDSTURBED SHEAR STRENGTH DATA
 Boring AT13#2
 CVX Gulf of Mexico Gas Hydrates JIP
 Block 13, Atwater Valley Area, Gulf of Mexico

Date:

Drawn By:

Date:

Date:

Checked By:

Approved By:

Normalized Shear Strength ($c_u/\sigma'_{v,d}$)

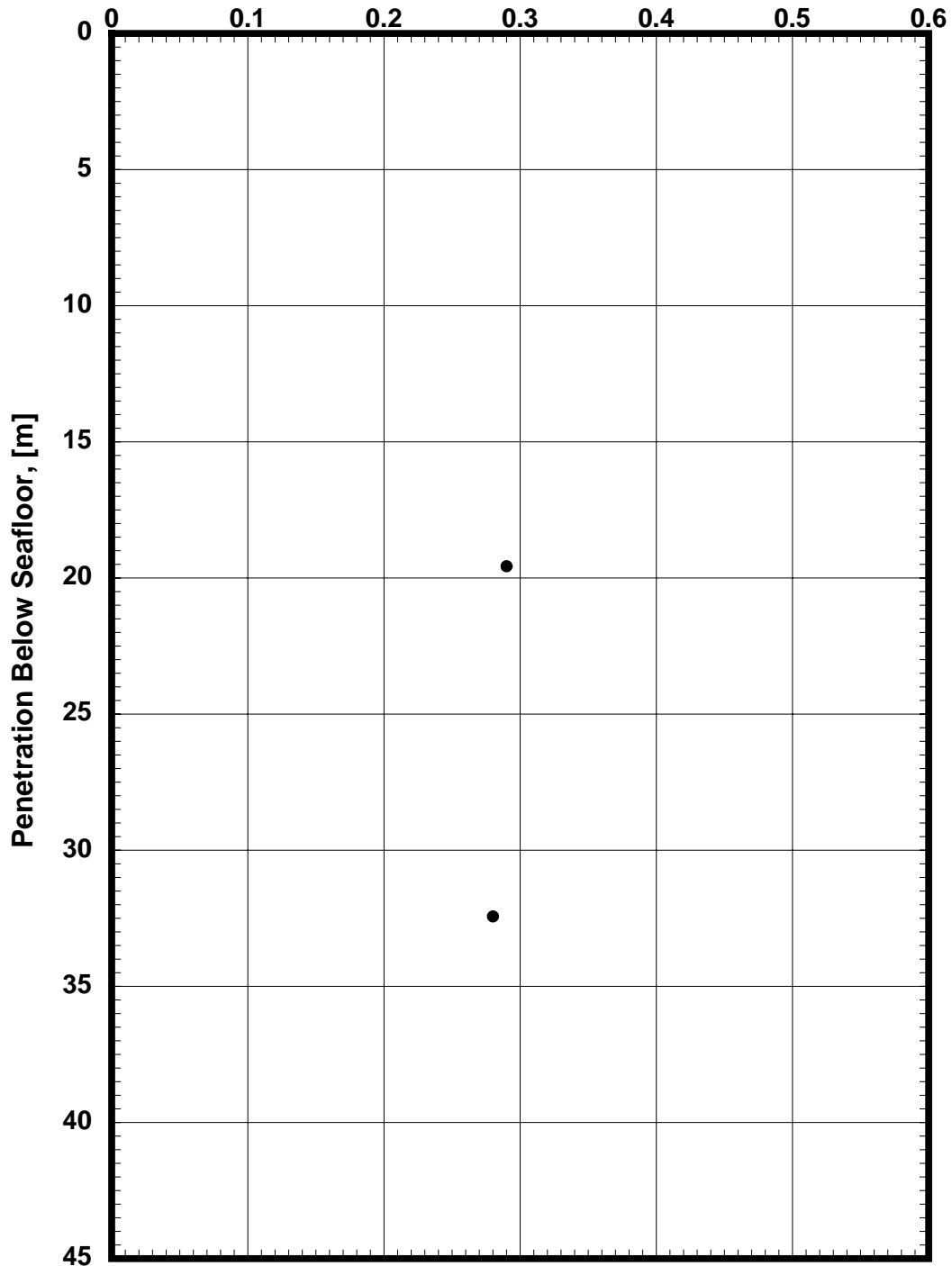

Normalized Shear Strength ($c_u/\sigma'_{v,d}$)
 Boring AT13#2
 CVX Gulf of Mexico Gas Hydrates JIP
 Block 13, Atwater Valley Area, Gulf of Mexico

Date:

Drawn By:

Date:

Date:

Checked By:

Approved By:

Remolded Shear Strength, [kPa]

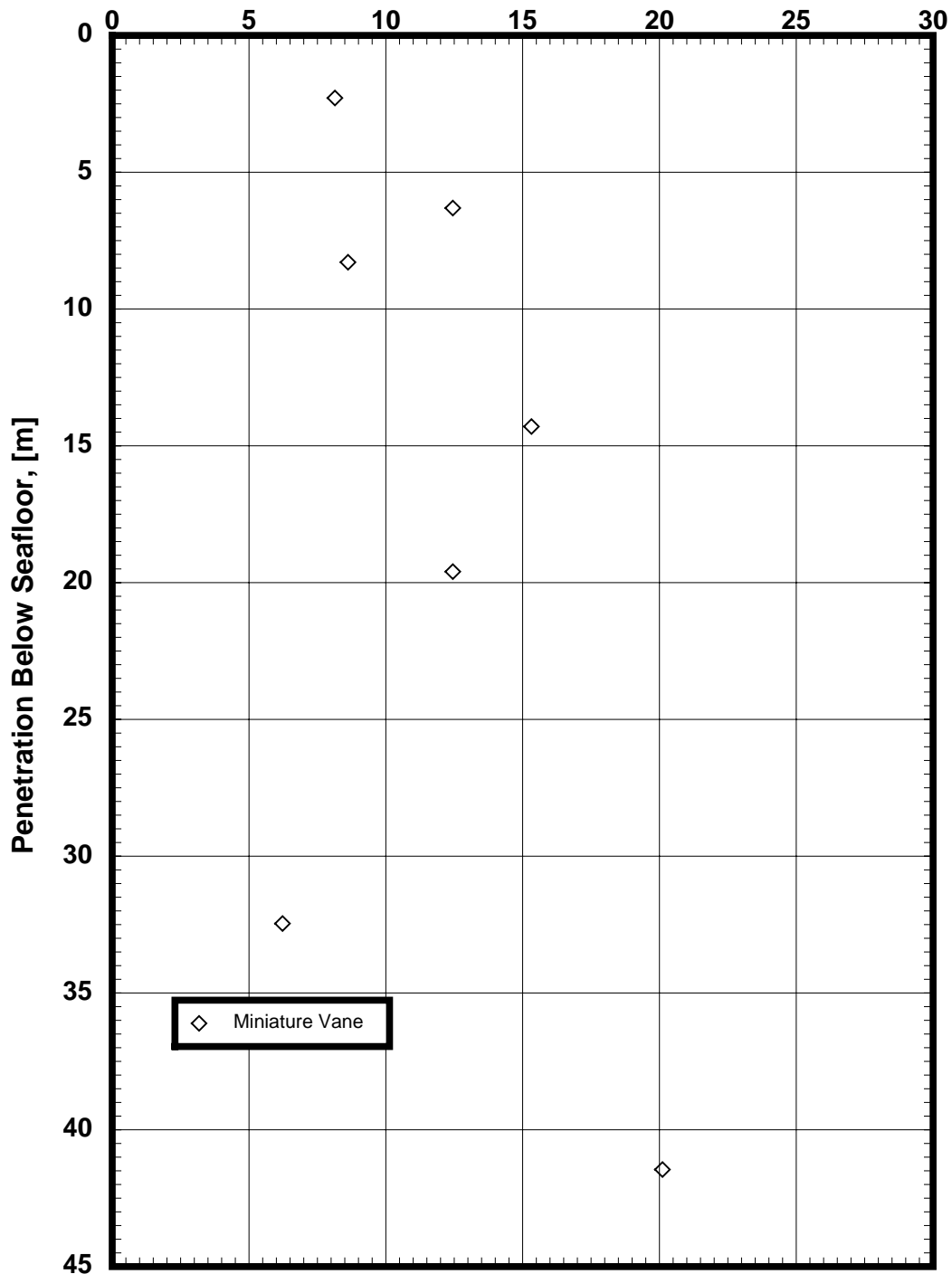

REMOLDED SHEAR STRENGTH DATA
 Boring AT13#2
 CVX Gulf of Mexico Gas Hydrates JIP
 Block 13, Atwater Valley Area, Gulf of Mexico

Date:

Drawn By:

Date:

Date:

Checked By:

Approved By:

Soil Sensitivity

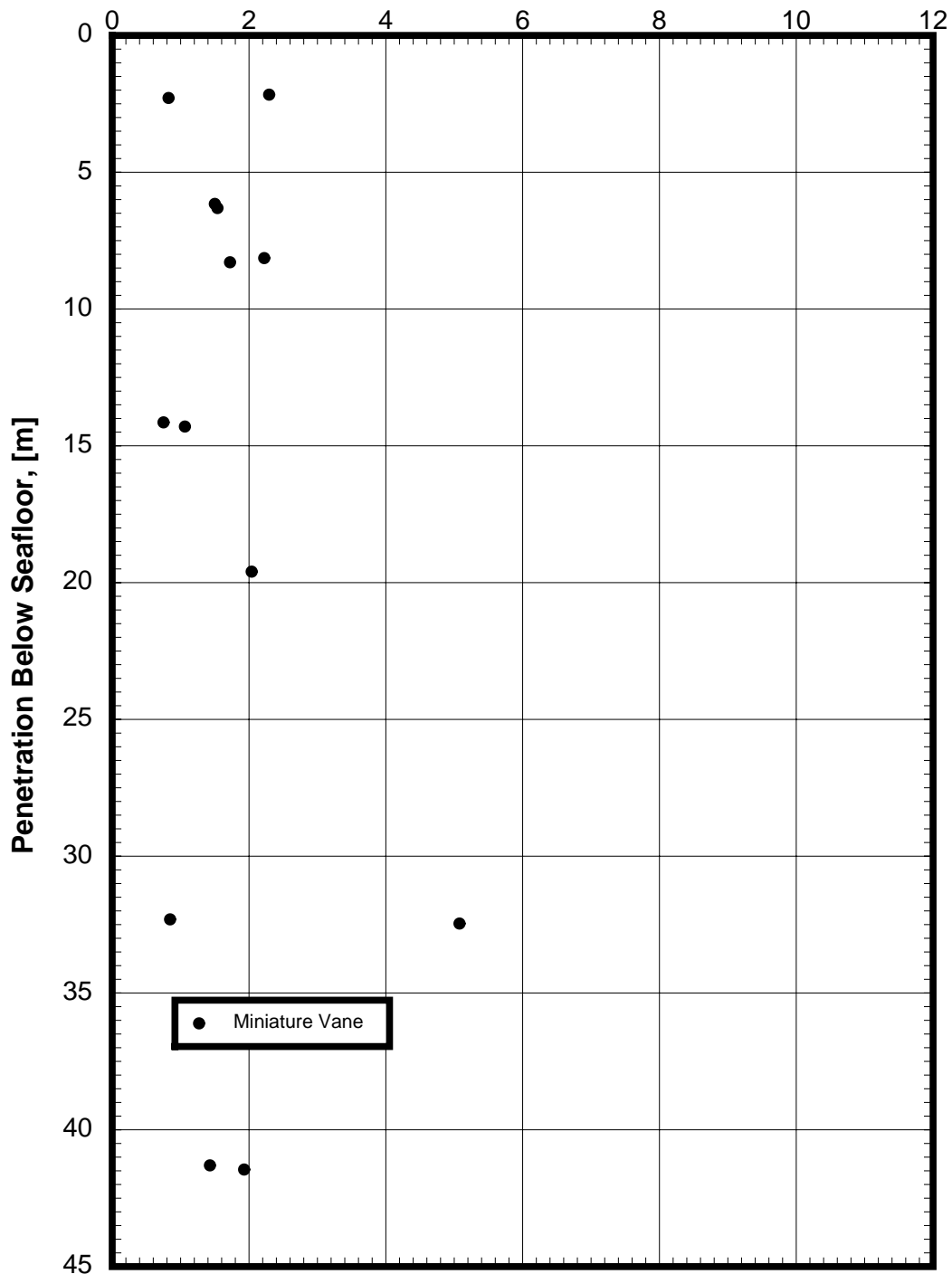

SOIL SENSITIVITY DATA
 Boring AT13#2
 CVX Gulf of Mexico Gas Hydrates JIP
 Block 13, Atwater Valley Area, Gulf of Mexico

Date:

Drawn By:

Date:

Date:

Checked By:

Approved By:

Water Content, [%]

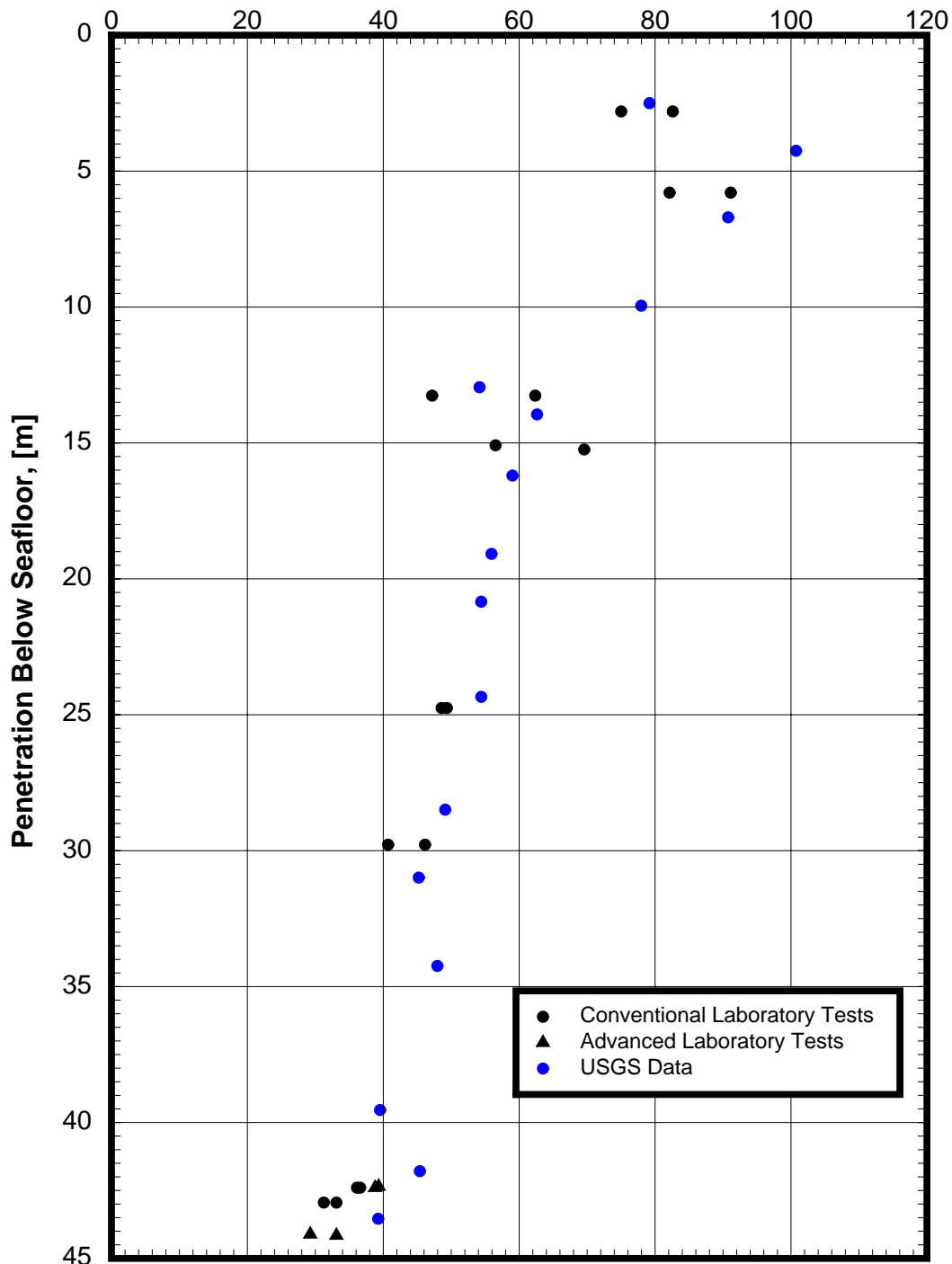

WATER CONTENT DATA
 Boring KC151#3
 CVX Gulf of Mexico Gas Hydrates JIP
 Block 151, Keathley Canyon Area, Gulf of Mexico

Date:

Drawn By:

Date:

Date:

Checked By:

Approved By:

Water Content, [%]

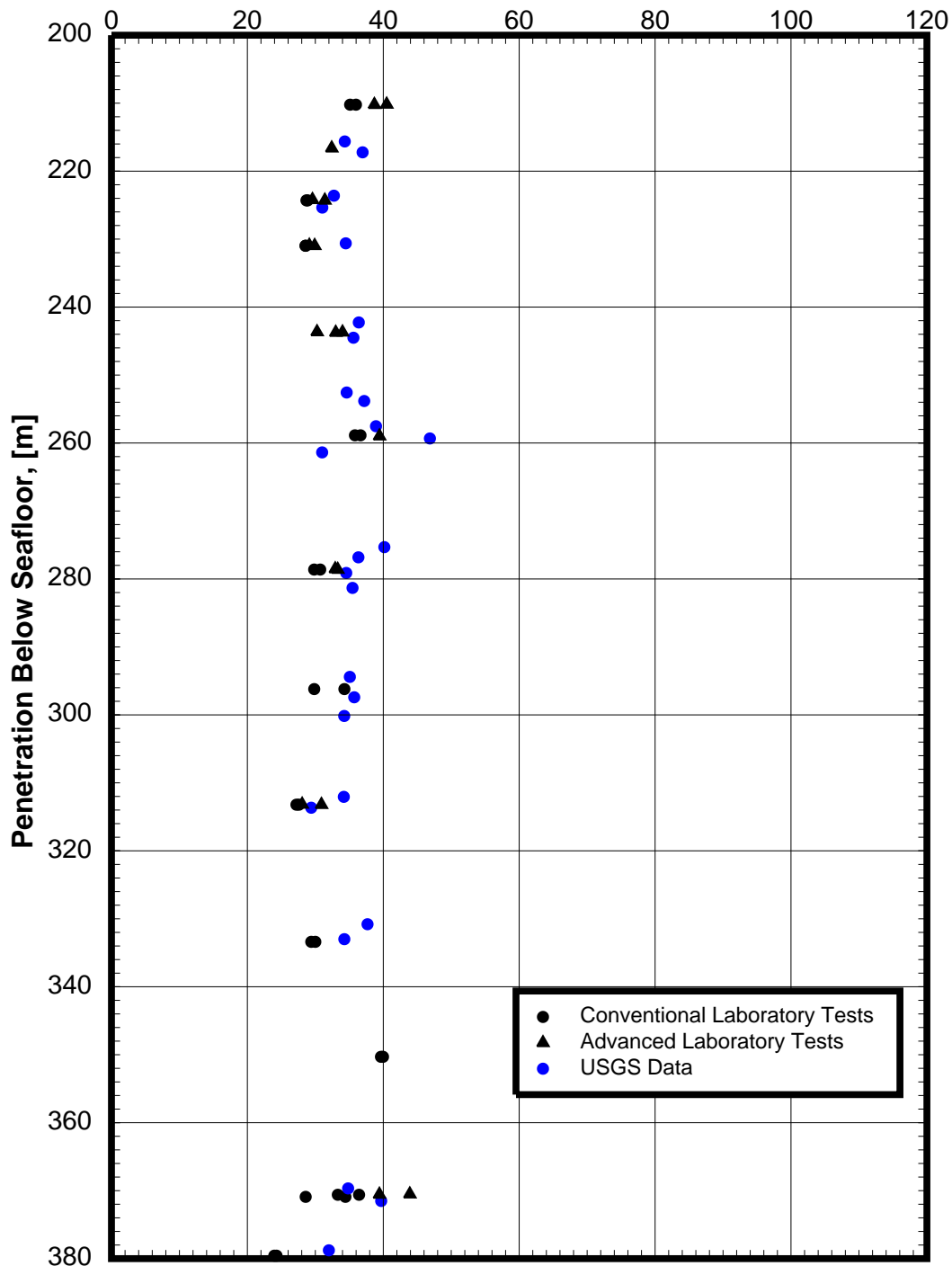

WATER CONTENT DATA
 Boring KC151#3
 CVX Gulf of Mexico Gas Hydrates JIP
 Block 151, Keathley Canyon Area, Gulf of Mexico

Date: _____
 Drawn By: _____
 Date: _____
 Checked By: _____
 Approved By: _____

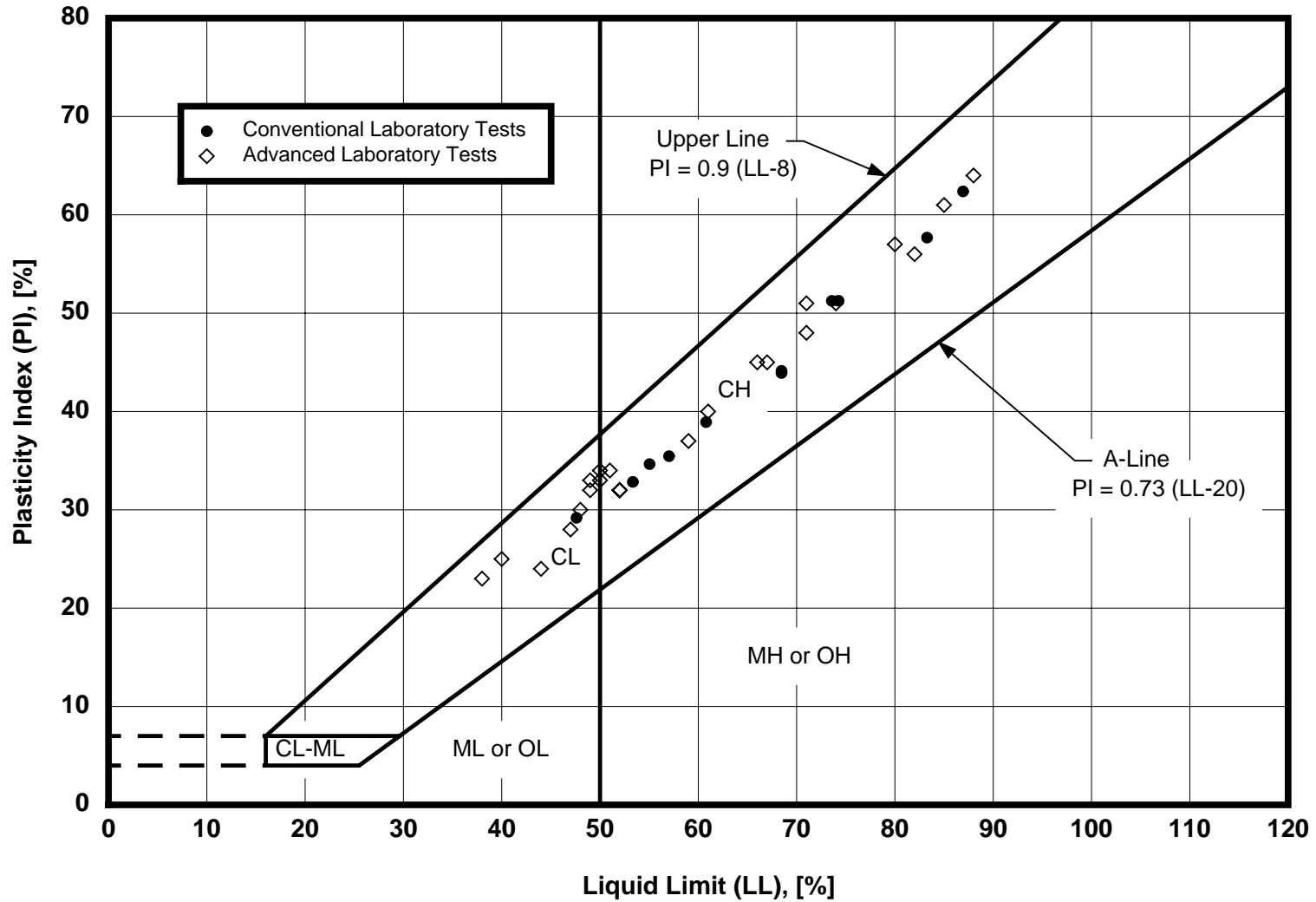

PLASTICITY CHART

Boring KC151#3
CVX Gulf of Mexico Gas Hydrates JIP
Block 151, Keathley Canyon Area, Gulf of Mexico

Plasticity Index (PI), [%]

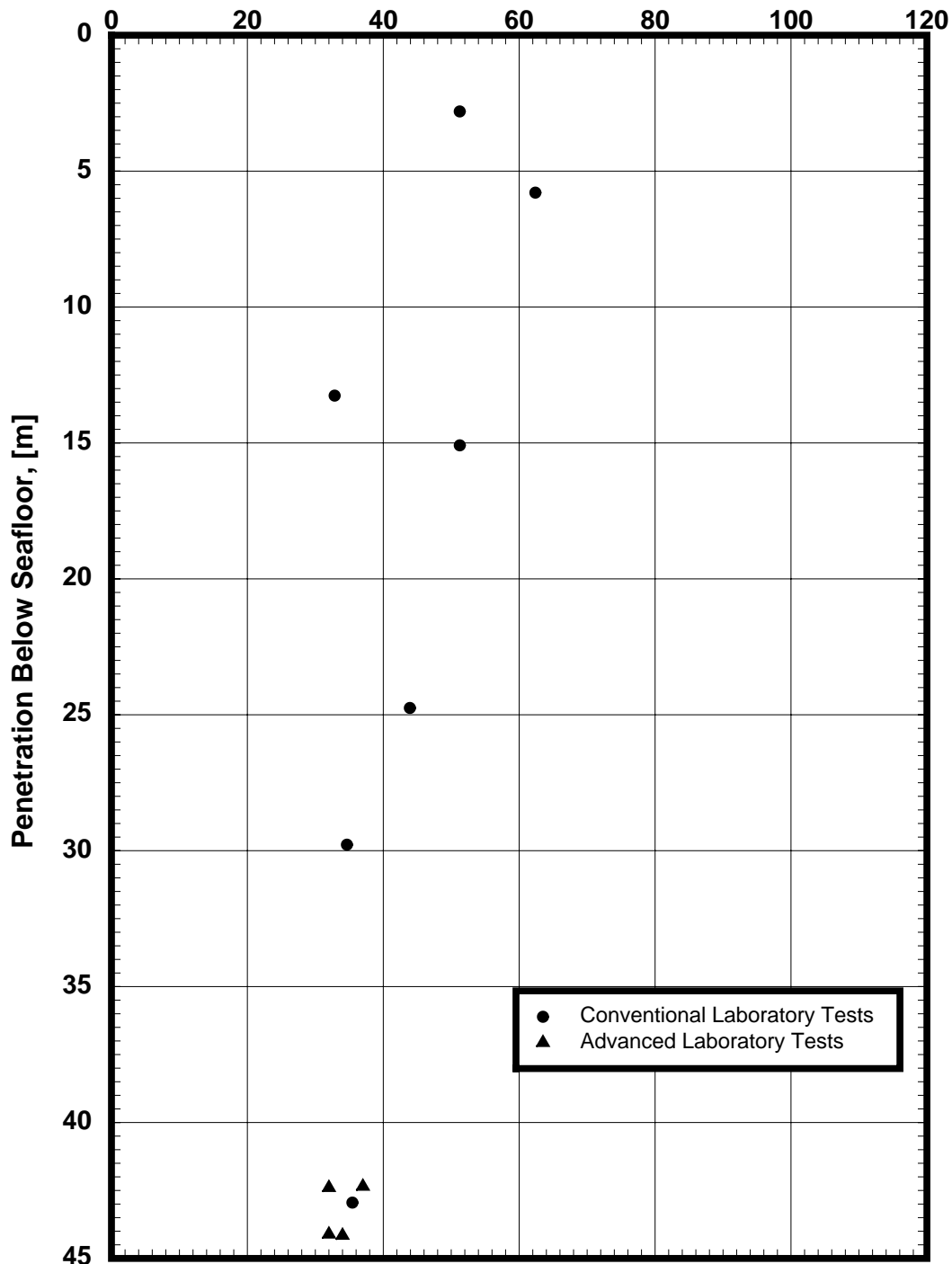

PLASTICITY INDEX DATA
 Boring KC151#3
 CVX Gulf of Mexico Gas Hydrates JIP
 Block 151, Keathley Canyon Area, Gulf of Mexico

Date:

Drawn By:

Date:

Date:

Checked By:

Approved By:

Plasticity Index (PI), [%]

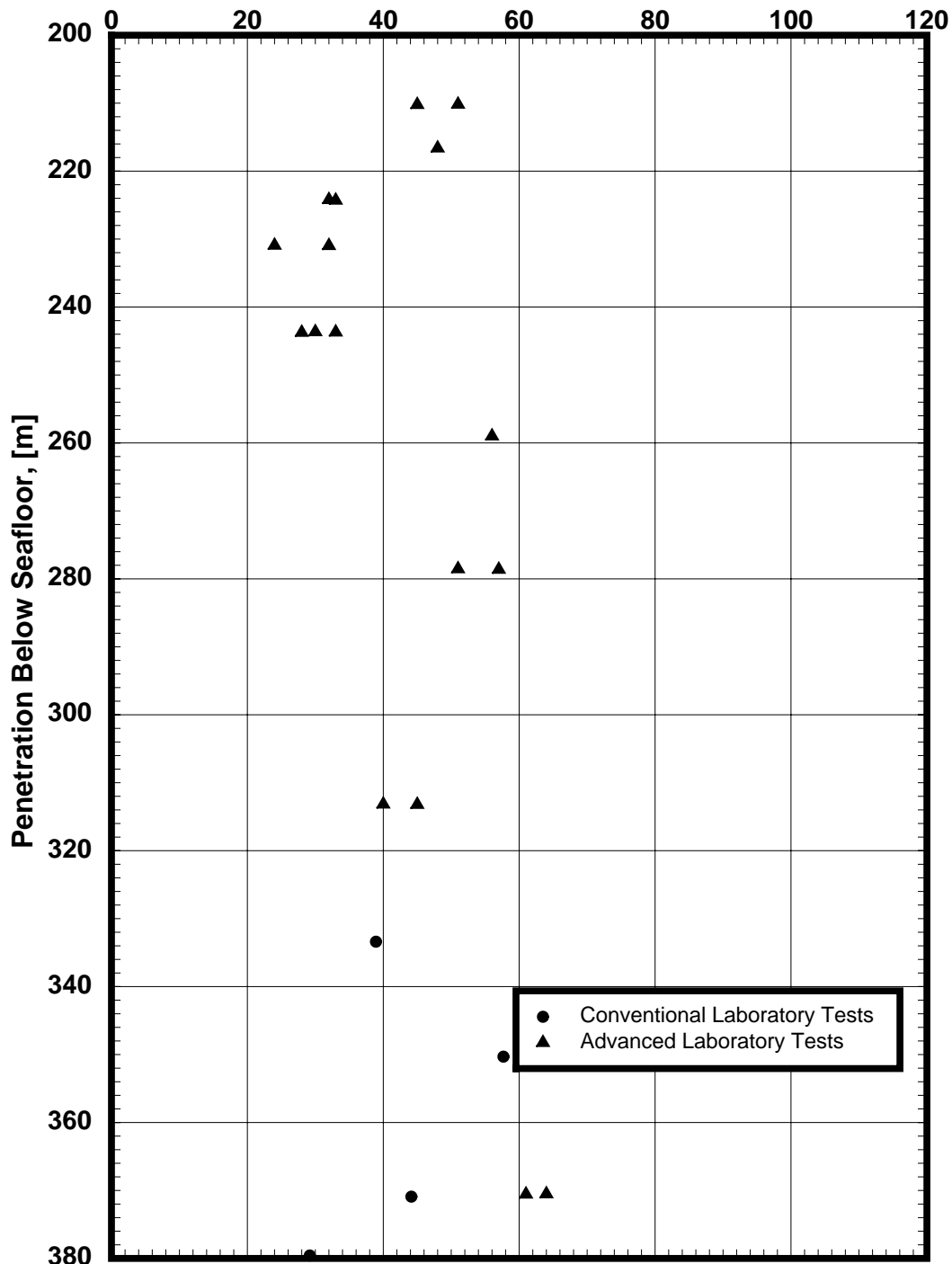

PLASTICITY INDEX DATA
 Boring KC151#3
 CVX Gulf of Mexico Gas Hydrates JIP
 Block 151, Keathley Canyon Area, Gulf of Mexico

Date:

Drawn By:

Date:

Date:

Checked By:

Approved By:

Liquidity Index (LI)

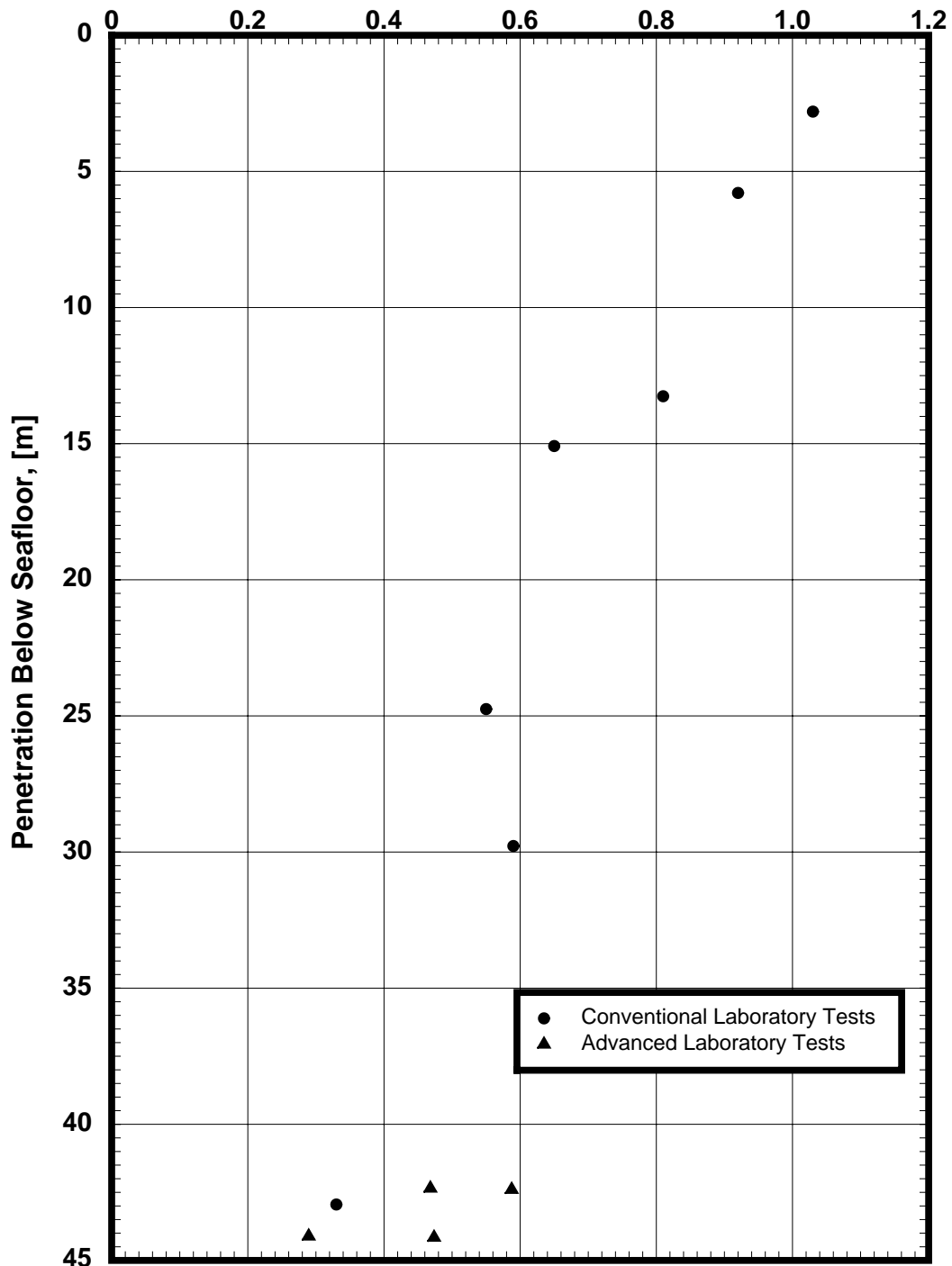

LIQUIDITY INDEX DATA
 Boring KC151#3
 CVX Gulf of Mexico Gas Hydrates JIP
 Block 151, Keathley Canyon Area, Gulf of Mexico

Date:

Drawn By:

Date:

Date:

Checked By:

Approved By:

Liquidity Index (LI)

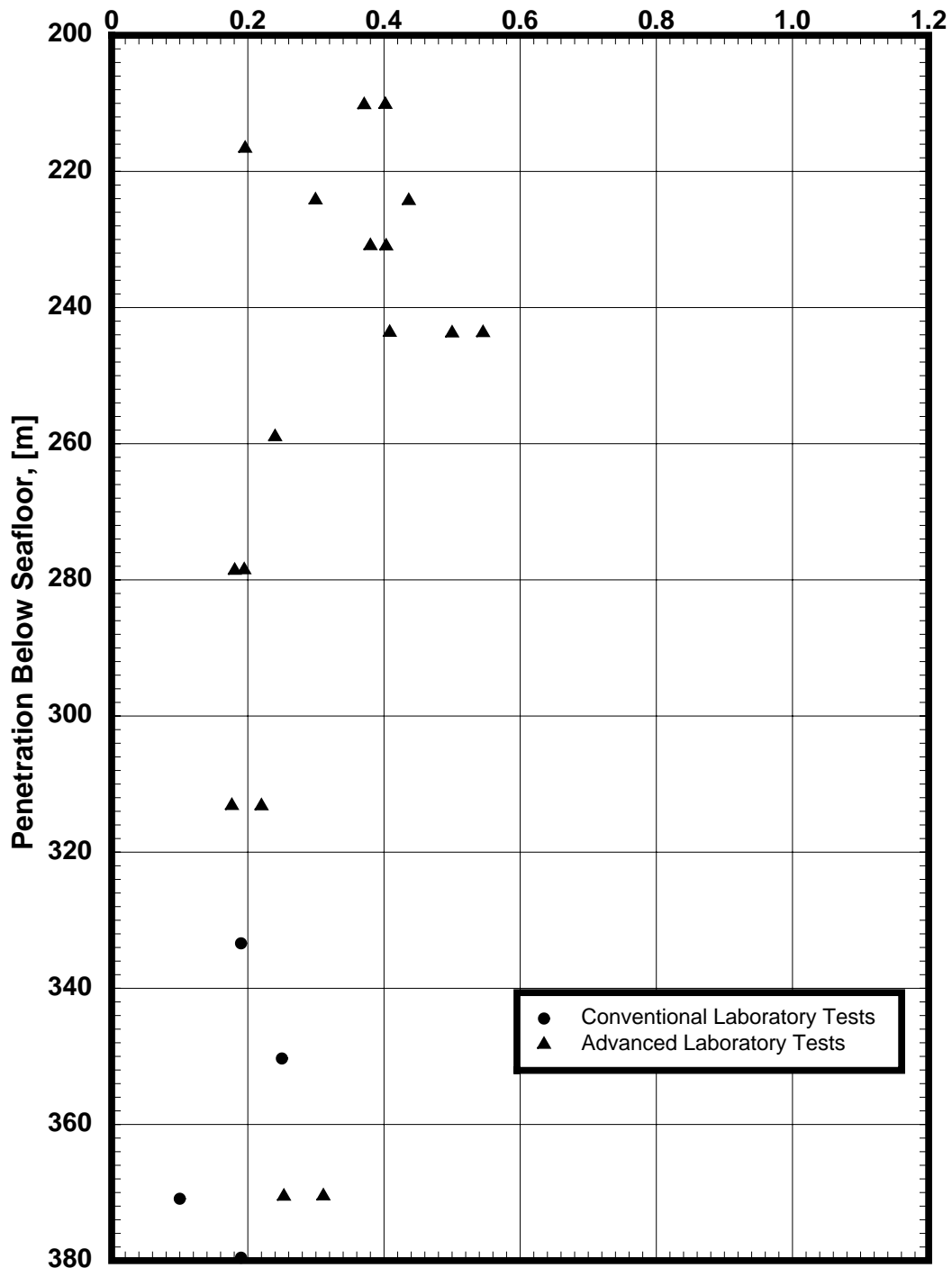

LIQUIDITY INDEX DATA
 Boring KC151#3
 CVX Gulf of Mexico Gas Hydrates JIP
 Block 151, Keathley Canyon Area, Gulf of Mexico

Date: _____
 Drawn By: _____
 Date: _____
 Checked By: _____
 Approved By: _____

Degree of Saturation, [%]

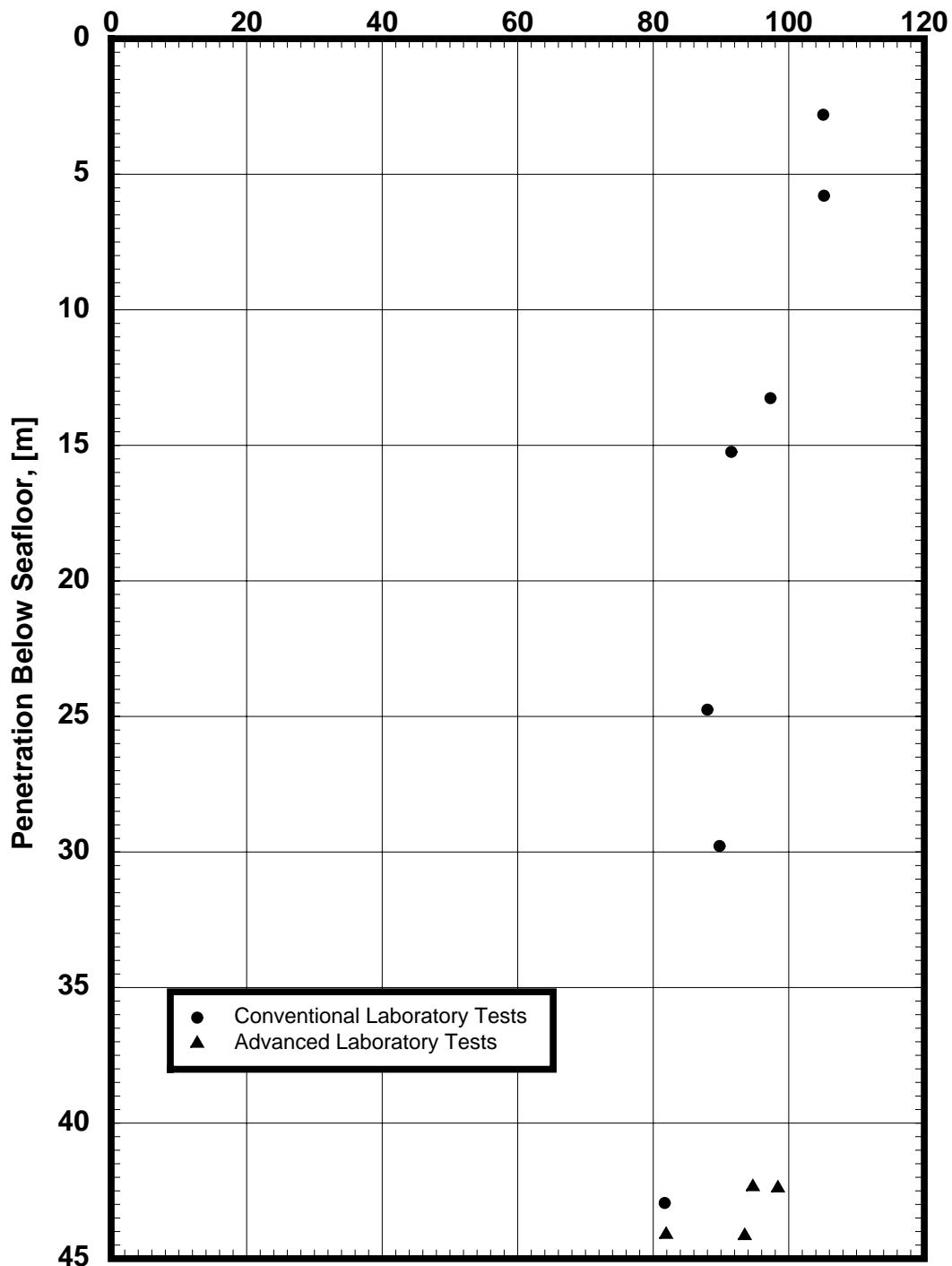

DEGREE OF SATURATION DATA
 Boring KC151#3
 CVX Gulf of Mexico Gas Hydrates JIP
 Block 151, Keathley Canyon Area, Gulf of Mexico

Date:

Drawn By:

Date:

Date:

Checked By:

Approved By:

Degree of Saturation, [%]

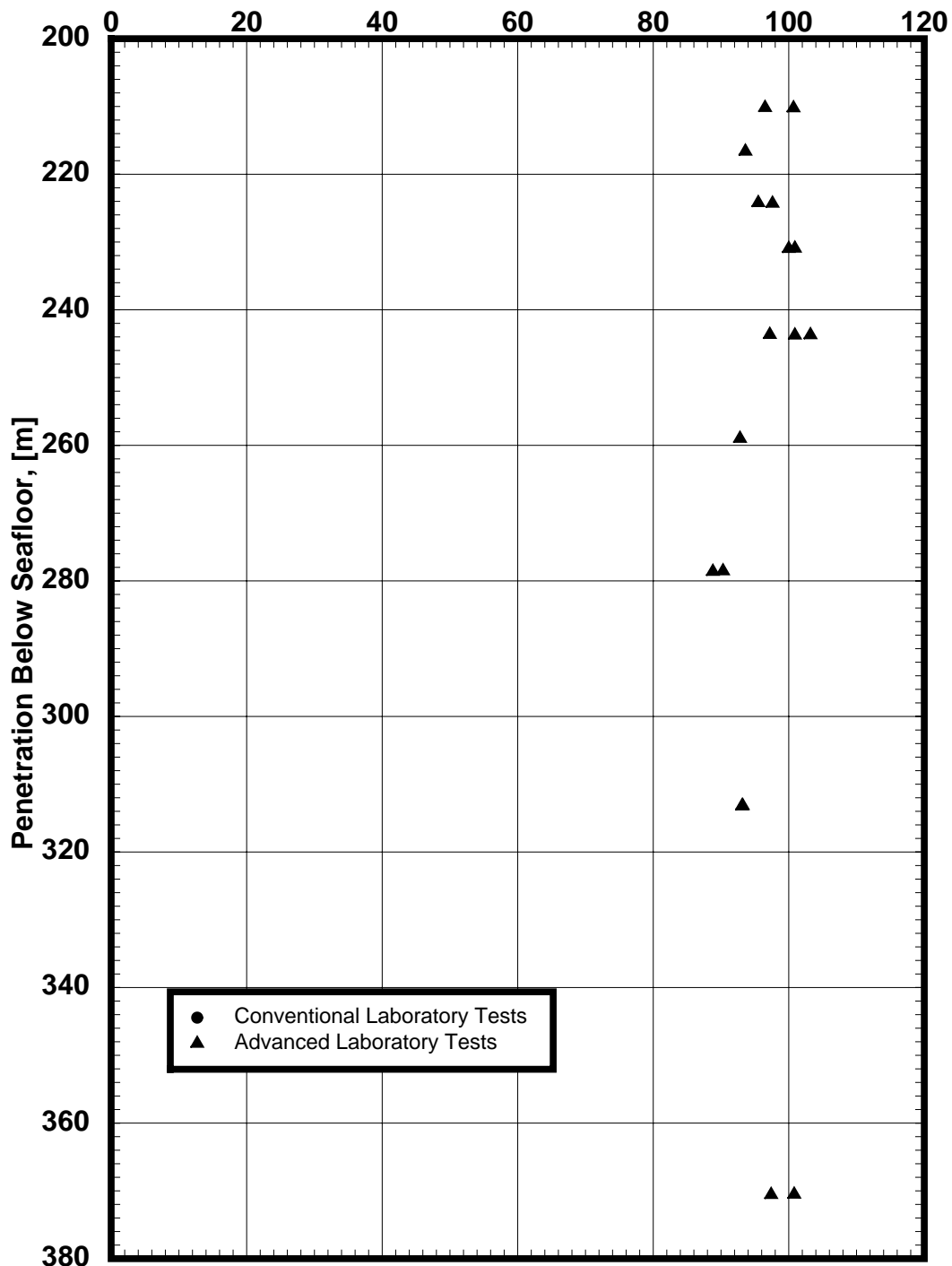

● Conventional Laboratory Tests
▲ Advanced Laboratory Tests

DEGREE OF SATURATION DATA
 Boring KC151#3
 CVX Gulf of Mexico Gas Hydrates JIP
 Block 151, Keathley Canyon Area, Gulf of Mexico

Date:
 Drawn By:
 Date:
 Date:
 Checked By:
 Approved By:

Submerged Unit Weight, [kN/m³]

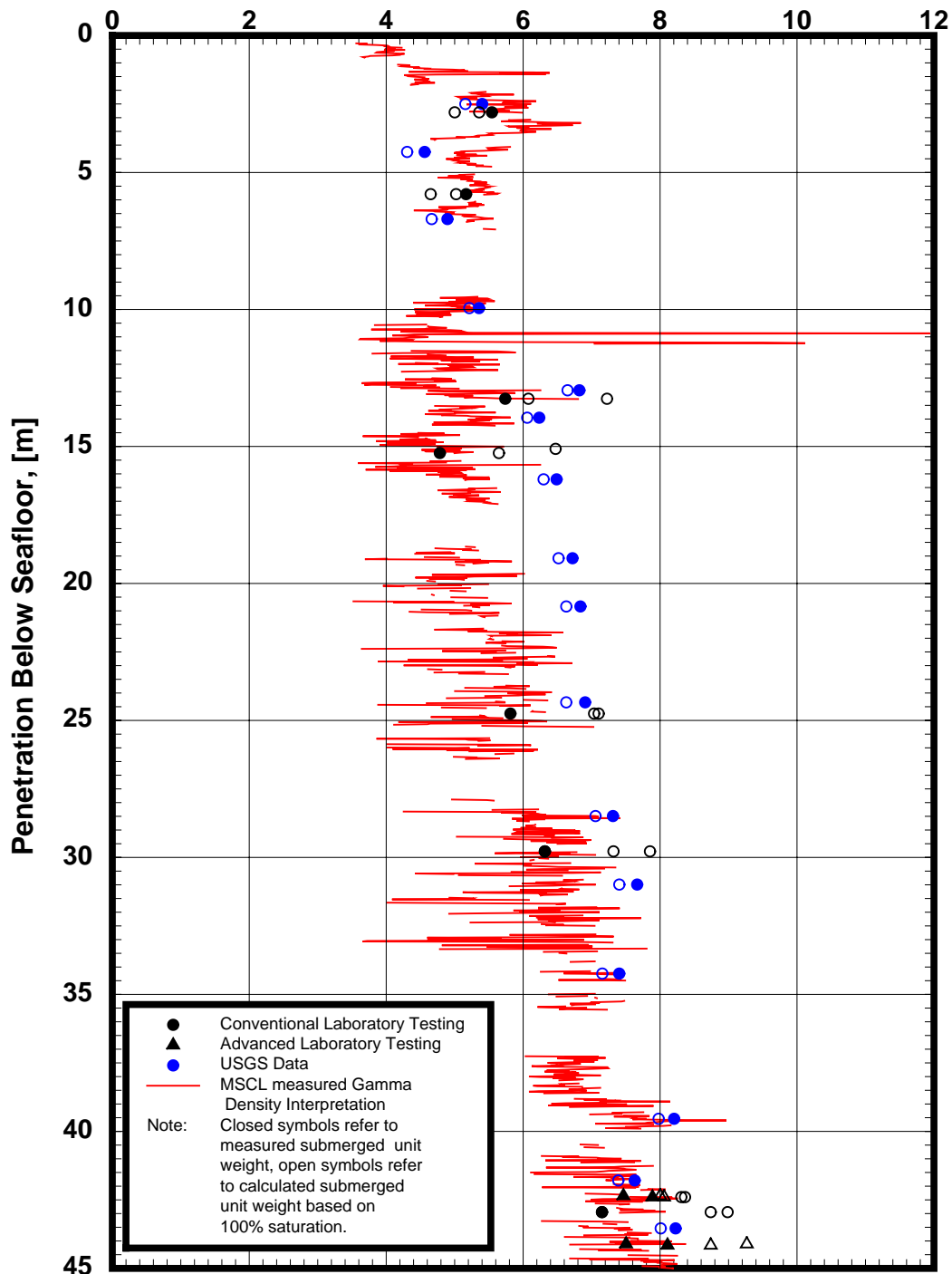

SUBMERGED UNIT WEIGHT DATA
 Boring KC151#3
 CVX Gulf of Mexico Gas Hydrates JIP
 Block 151, Keathley Canyon Area, Gulf of Mexico

Date:

Drawn By:

Date:

Date:

Checked By:

Approved By:

Submerged Unit Weight, [kN/m³]

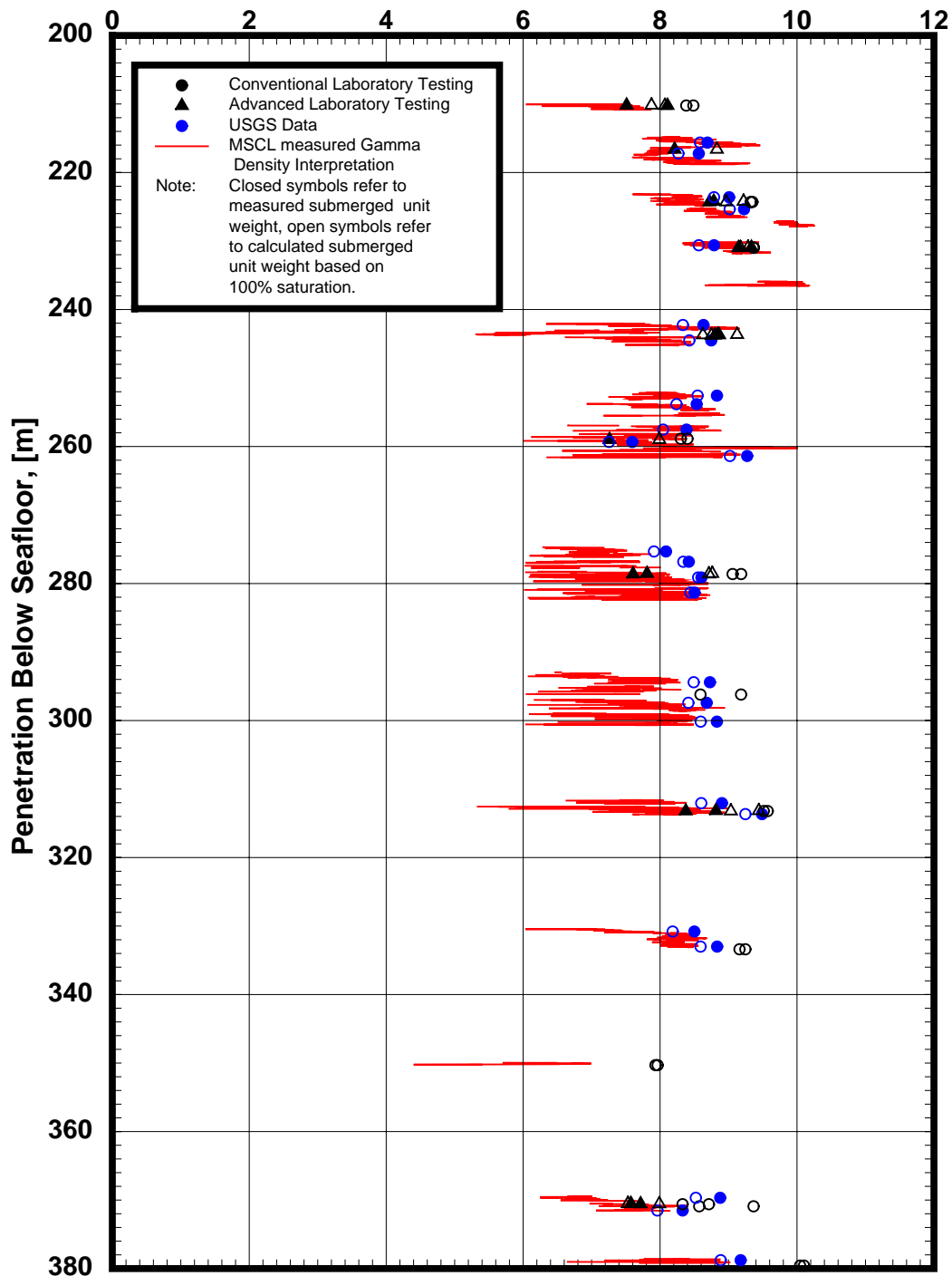

SUBMERGED UNIT WEIGHT DATA
 Boring KC151#3
 CVX Gulf of Mexico Gas Hydrates JIP
 Block 151, Keathley Canyon Area, Gulf of Mexico

Date: _____
 Drawn By: _____
 Date: _____
 Date: _____
 Checked By: _____
 Approved By: _____

Effective Vertical Stress, [kPa]

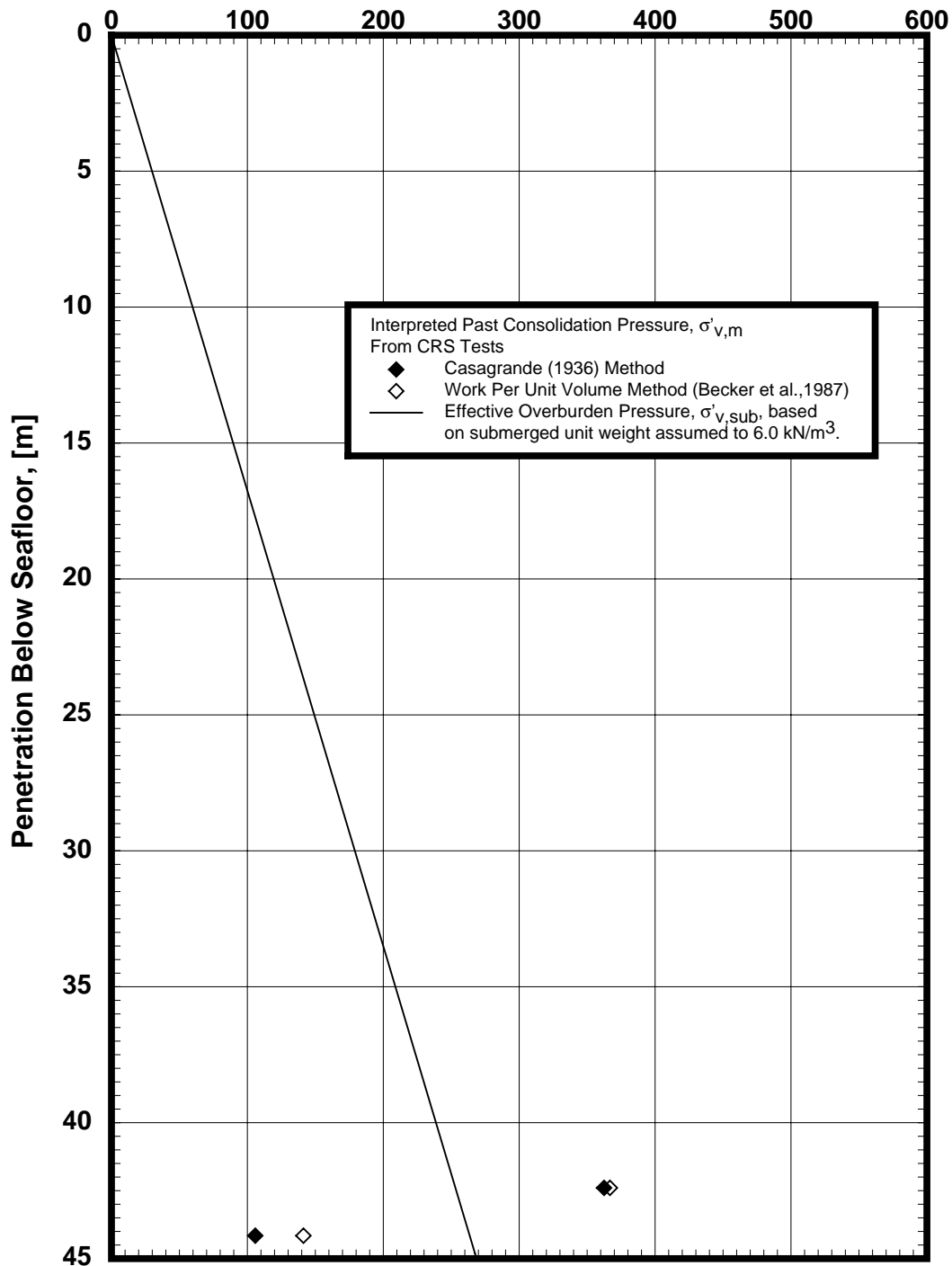

INTERPRETED EFFECTIVE VERTICAL STRESS PROFILE

Boring KC151#3

CVX Gulf of Mexico Gas Hydrates JIP

Block 151, Keathley Canyon Area, Gulf of Mexico

Date:

Drawn By:

Date:

Date:

Checked By:

Approved By:

Effective Vertical Stress, [kPa]

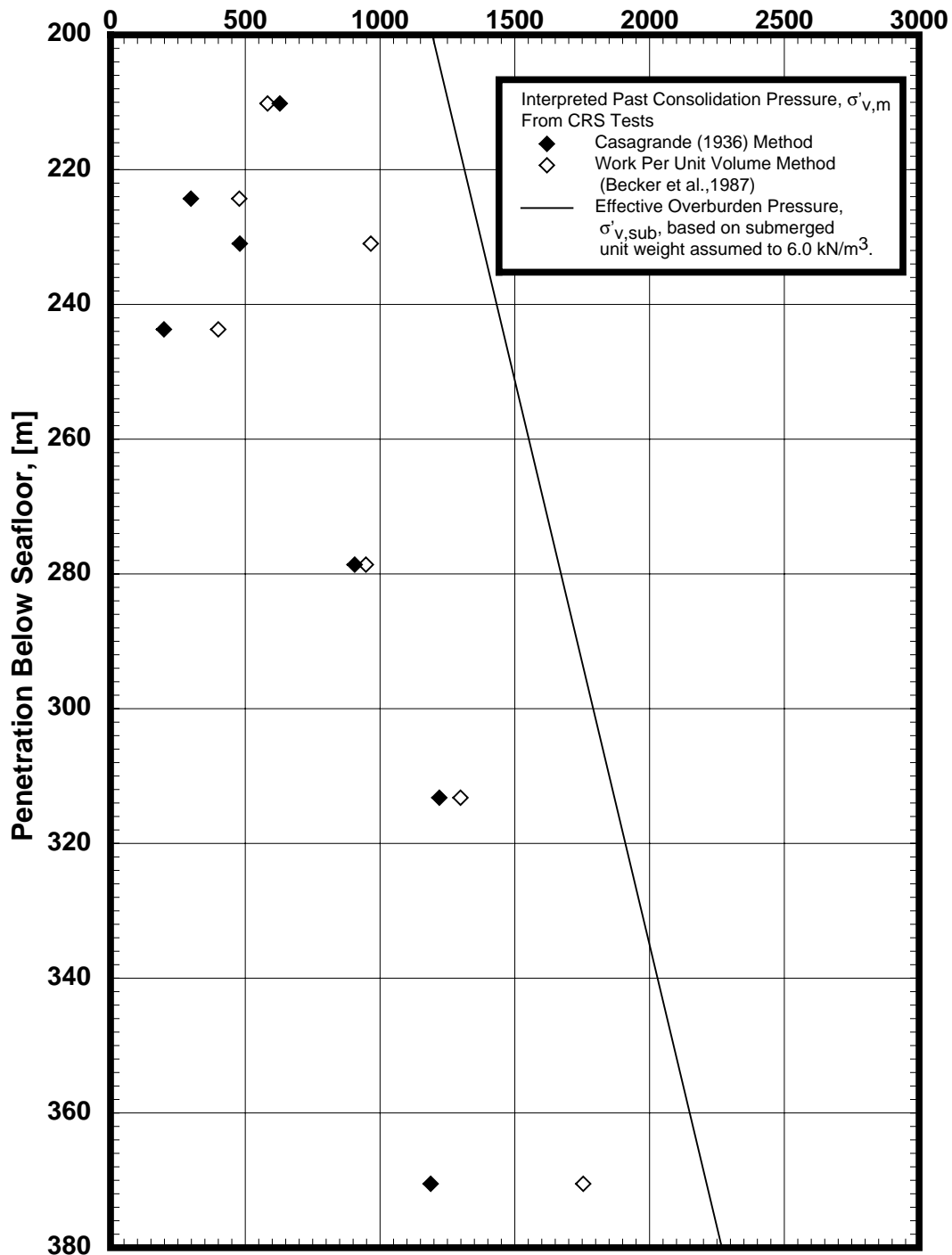

INTERPRETED EFFECTIVE VERTICAL STRESS PROFILE

Boring KC151#3

CVX Gulf of Mexico Gas Hydrates JIP

Block 151, Keathley Canyon Area, Gulf of Mexico

Date:

Drawn By:

Date:

Date:

Checked By:

Approved By:

Undrained Shear Strength, [kPa]

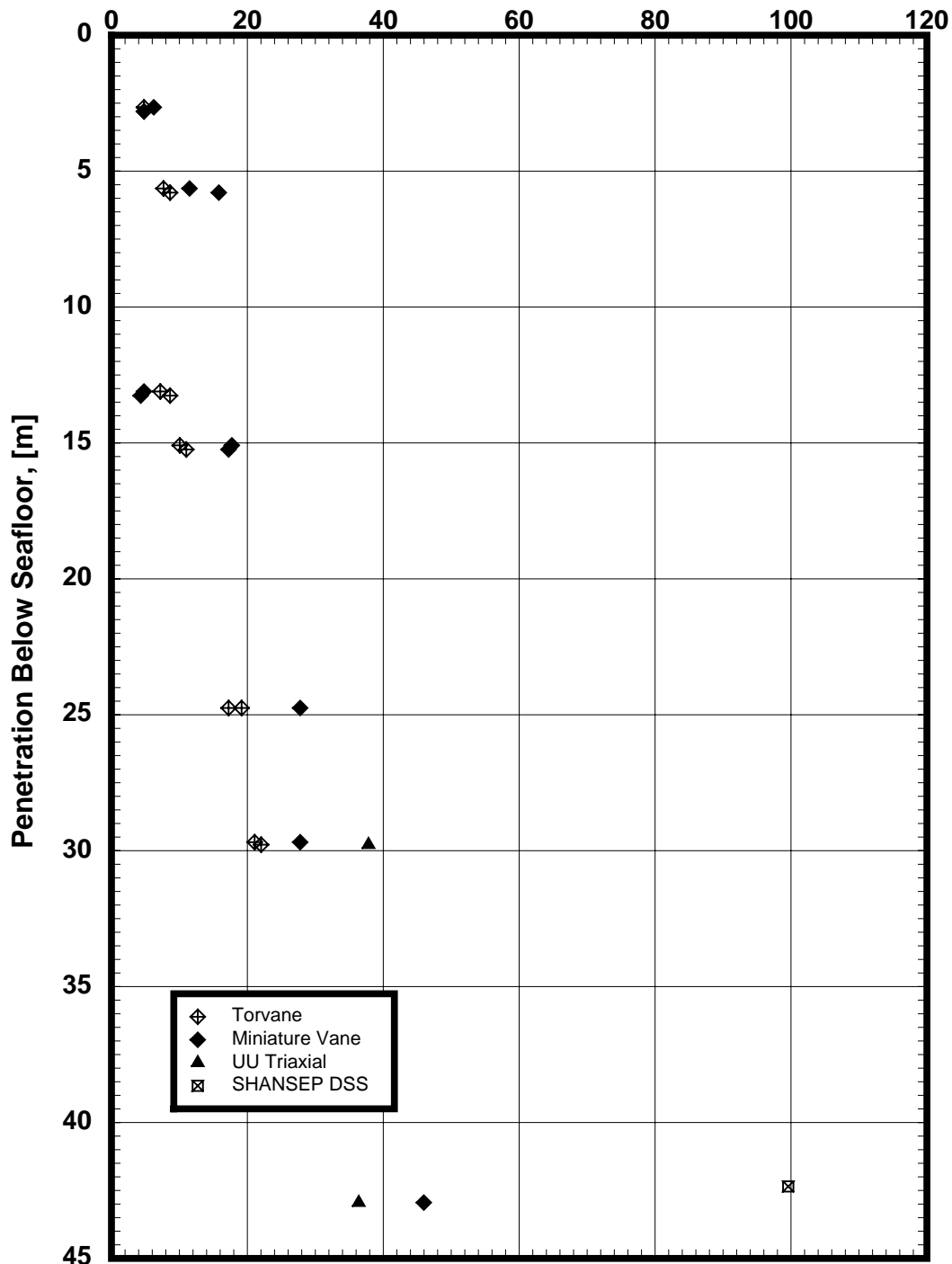

UNIDSTURBED SHEAR STRENGTH DATA
 Boring KC151#3
 CVX Gulf of Mexico Gas Hydrates JIP
 Block 151, Keathley Canyon Area, Gulf of Mexico

Date:

Drawn By:

Date:

Date:

Checked By:

Approved By:

Undrained Shear Strength, [kPa]

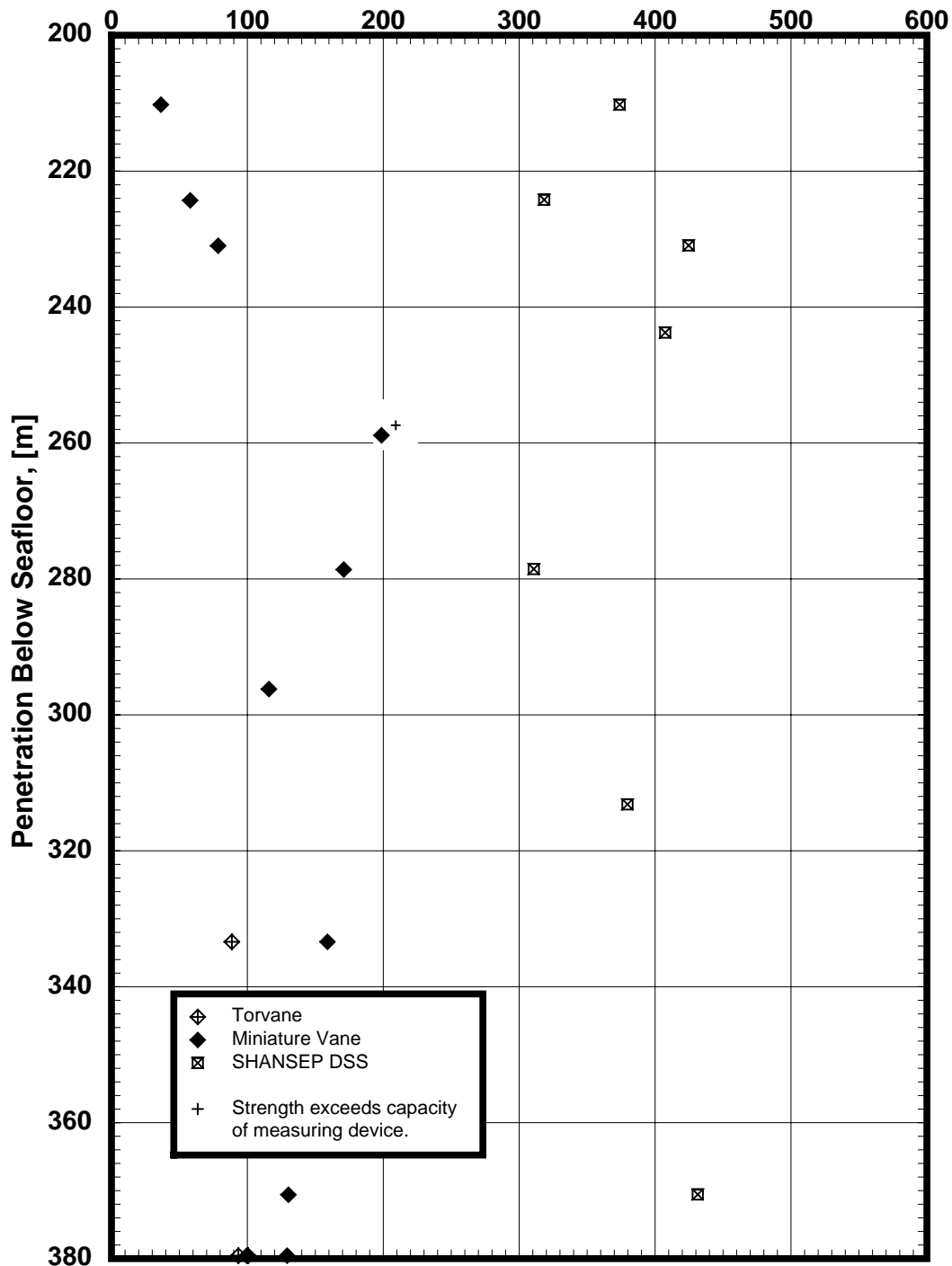

UNIDSTURBED SHEAR STRENGTH DATA
 Boring KC151#3
 CVX Gulf of Mexico Gas Hydrates JIP
 Block 151, Keathley Canyon Area, Gulf of Mexico

Date:

Drawn By:

Date:

Date:

Checked By:

Approved By:

Normalized Shear Strength ($c_u/\sigma'_{v,d}$)

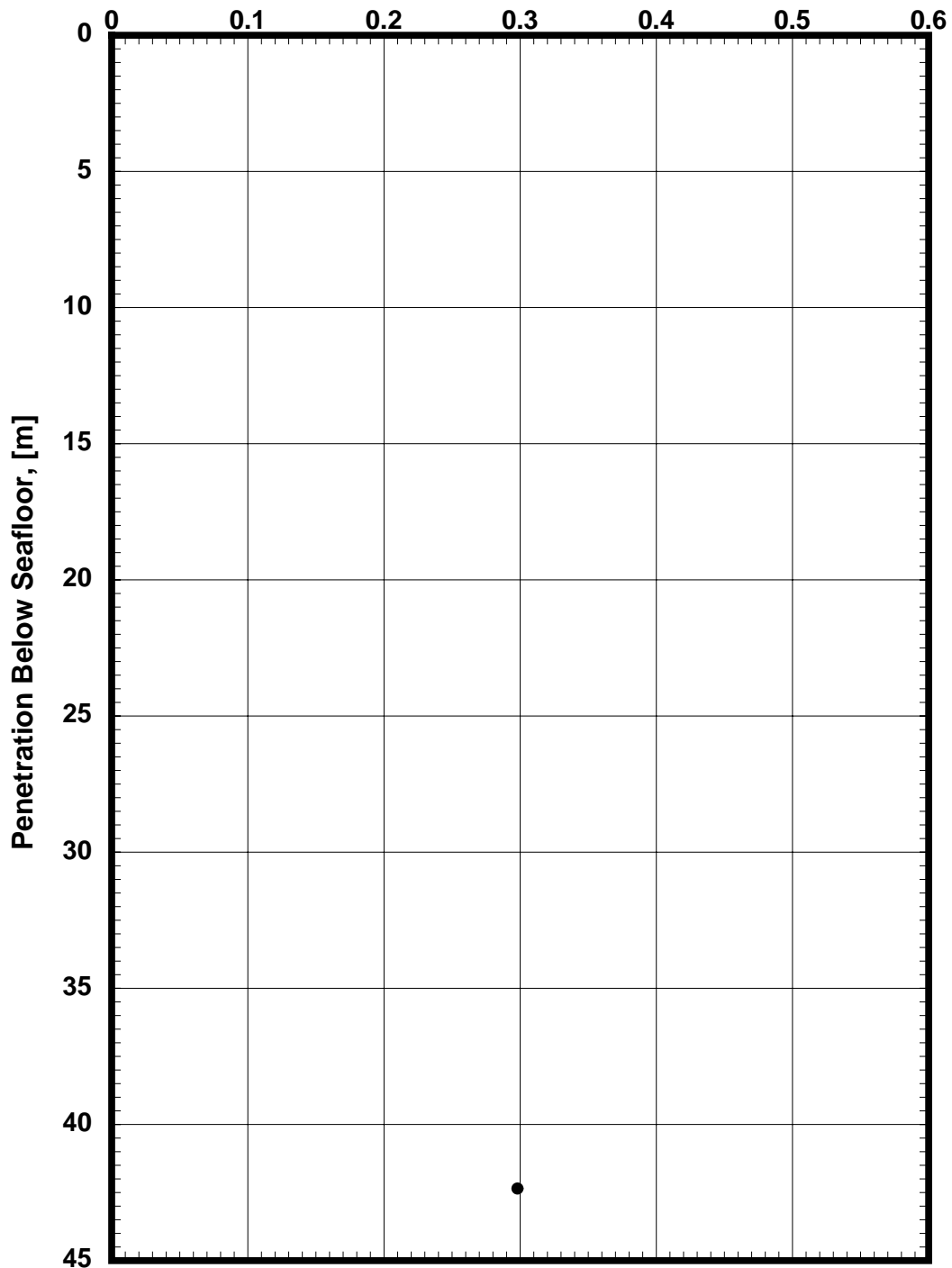

Normalized Shear Strength ($c_u/\sigma'_{v,d}$)
 Boring KC151#3
 CVX Gulf of Mexico Gas Hydrates JIP
 Block 151, Keathley Canyon Area, Gulf of Mexico

Date:

Drawn By:

Date:

Date:

Checked By:

Approved By:

Normalized Shear Strength ($c_u/\sigma'_{v,d}$)

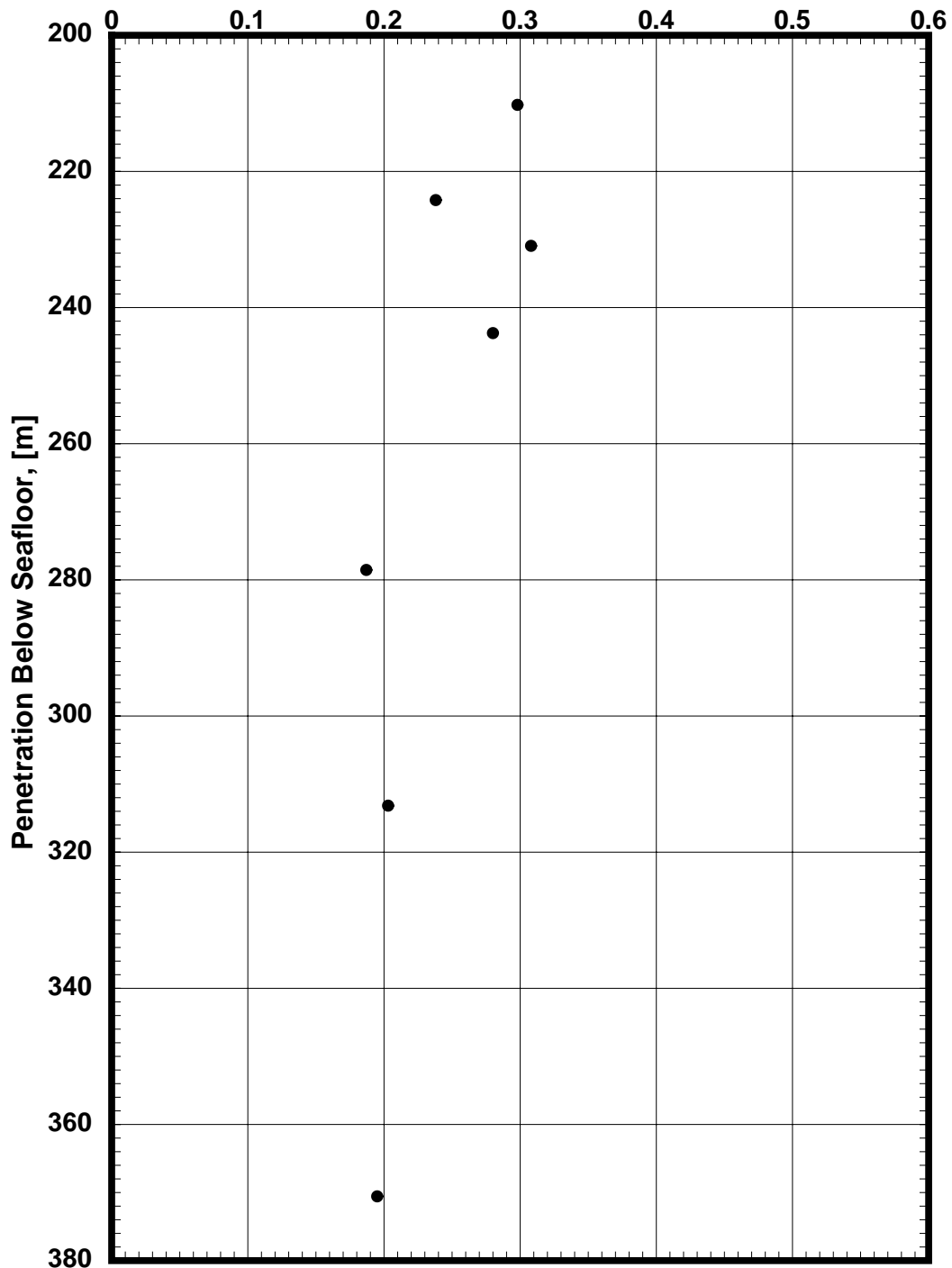

Normalized Shear Strength ($c_u/\sigma'_{v,d}$)
 Boring KC151#3
 CVX Gulf of Mexico Gas Hydrates JIP
 Block 151, Keathley Canyon Area, Gulf of Mexico

Date:

Drawn By:

Date:

Date:

Checked By:

Approved By:

Remolded Shear Strength, [kPa]

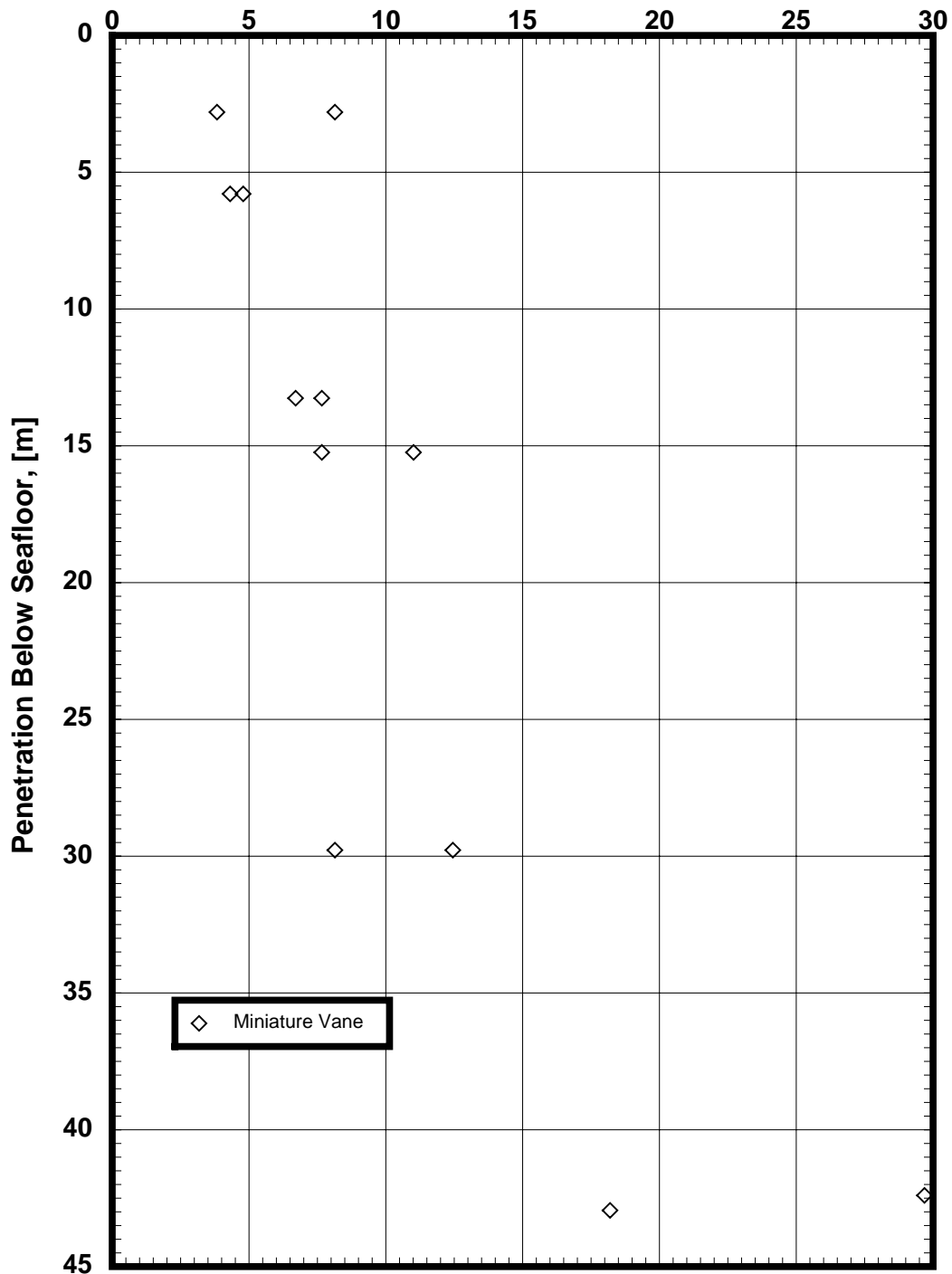

REMOLDED SHEAR STRENGTH DATA
 Boring KC151#3
 CVX Gulf of Mexico Gas Hydrates JIP
 Block 151, Keathley Canyon Area, Gulf of Mexico

Date:

Drawn By:

Date:

Date:

Checked By:

Approved By:

Remolded Shear Strength, [kPa]

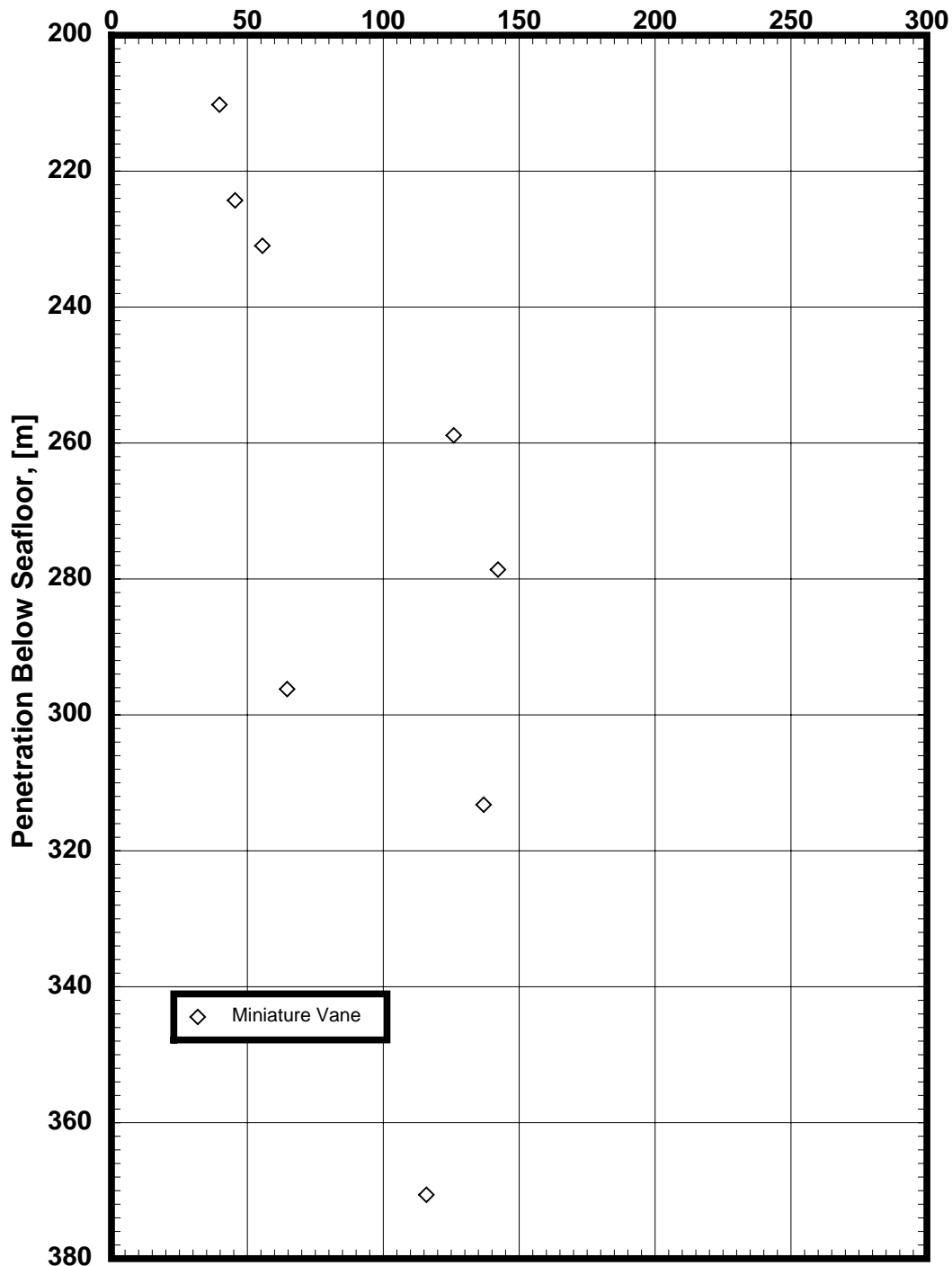

REMOLDED SHEAR STRENGTH DATA
 Boring KC151#3
 CVX Gulf of Mexico Gas Hydrates JIP
 Block 151, Keathley Canyon Area, Gulf of Mexico

Date:

Drawn By:

Date:

Date:

Checked By:

Approved By:

Soil Sensitivity

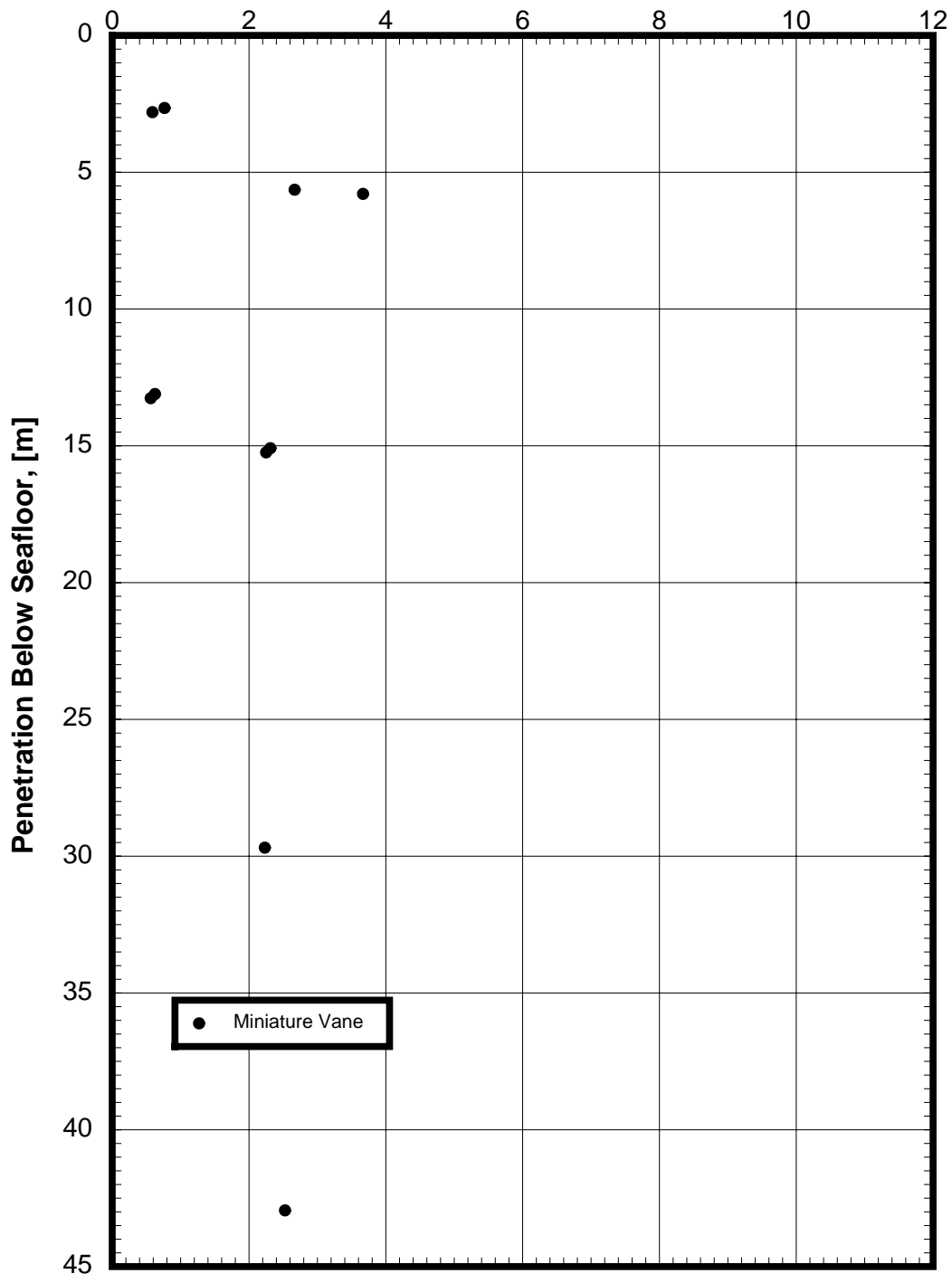

SOIL SENSITIVITY DATA
 Boring KC151#3
 CVX Gulf of Mexico Gas Hydrates JIP
 Block 151, Keathley Canyon Area, Gulf of Mexico

Date:

Drawn By:

Date:

Date:

Checked By:

Approved By:

Soil Sensitivity

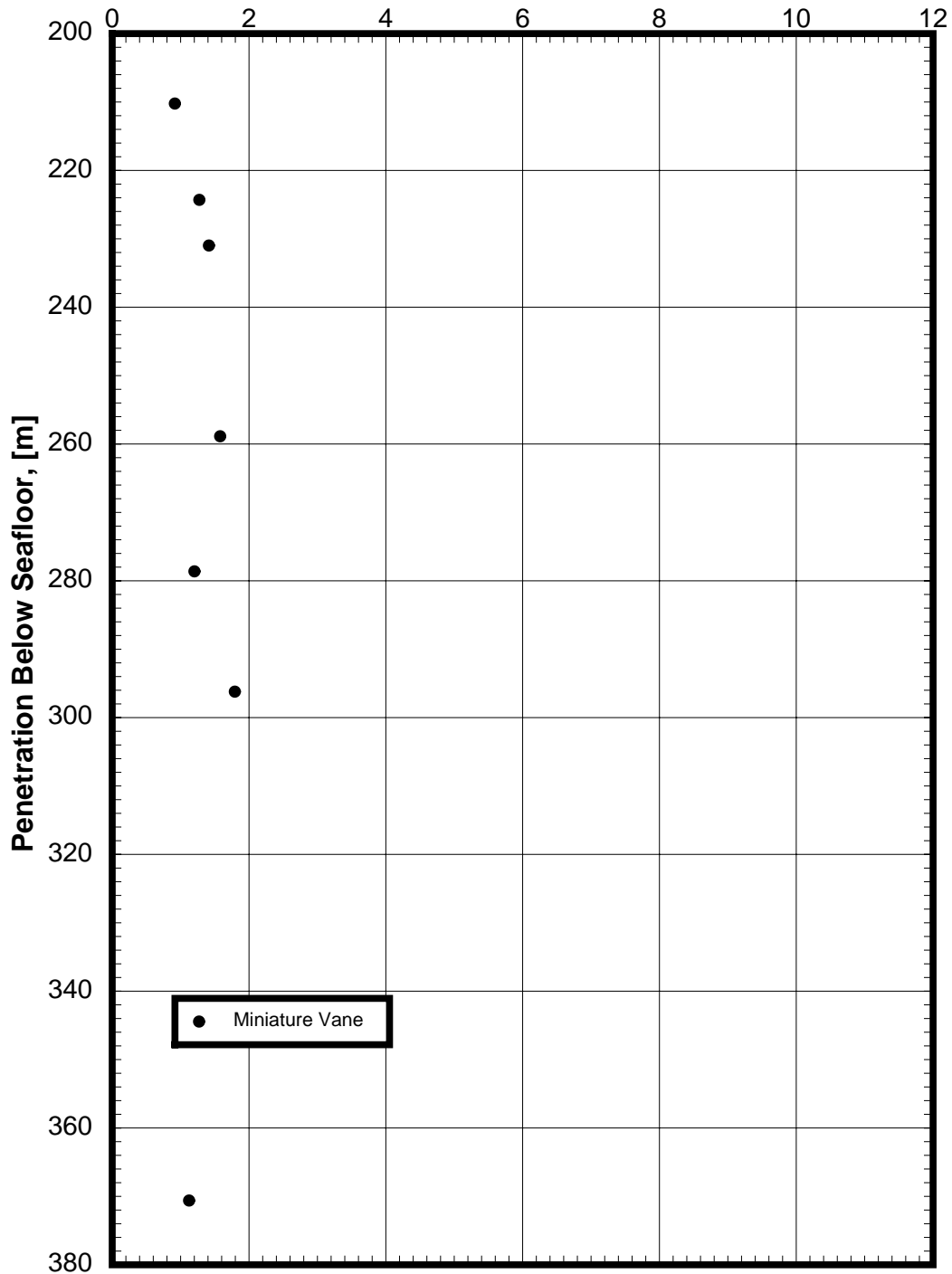

SOIL SENSITIVITY DATA
 Boring KC151#3
 CVX Gulf of Mexico Gas Hydrates JIP
 Block 151, Keathley Canyon Area, Gulf of Mexico

Date:

Drawn By:

Date:

Date:

Checked By:

Approved By:

APPENDIX A
FIELD INVESTIGATION AND FIELD LABORATORY TESTING

**FIELD INVESTIGATION AND FIELD LABORATORY TESTING
CONTENTS**

	<u>Page</u>
FIELD INVESTIGATION	A-1
Operational Facilities and Personnel	A-1
Positioning and Vessel Operations	A-1
Drilling Equipment and Procedures	A-1
Derrick and Rotating Equipment	A-1
Drill String.....	A-1
Coring Equipment and Procedures – Non-Pressurized Systems	A-2
Fugro-Hydraulic Piston Corer (FHPC)	A-2
Fugro Corer (FC).....	A-3
Sampling Equipment and Procedures – Pressurized Systems	A-4
Fugro Pressure Corer (FPC).....	A-4
HYACE Rotary Corer (HRC).....	A-4
CTD Testing Equipment and Procedures	A-4
Advanced Piston Corer Temperature Tool	A-5
Water Depth Measurements	A-5
FIELD LABORATORY TESTING.....	A-6
Classification Tests	A-6
Water Content and Density Measurements	A-6
Carbonate Content Tests	A-6
Strength Tests	A-6
Torvane Tests	A-6
Pocket Penetrometer Tests	A-6
Miniature Vane Tests	A-6
Unconsolidated-Undrained Triaxial Compression Tests.....	A-7

ILLUSTRATIONS

	<u>Plate</u>
Summary of Field Operations	A-1
Fugro Hydraulic Piston Corer	A-2
Fugro Corer	A-3
Fugro Pressure Corer	A-4
Hyace Rotary Corer	A-5
Data Sheet – SBE Seacat CTD Profiler	A-6
Data Sheet – Advanced Piston Corer Temperature (APCT) Tool	A-7

FIELD INVESTIGATION

Operational Facilities and Personnel

The vessel used for the field phase of the scientific research investigation was the MSV *Uncle John* owned and operated by CalDive International. The vessel is a dynamically positioned, twin hull, semi-submersible vessel approximately 253 ft in length and 173 ft wide. The Superintendent and Master of the MSV *Uncle John* were in charge of vessel operation and personnel safety during drilling and related sub-surface activities. Fugro-McClelland Marine Geosciences, Inc. provided geotechnical engineers, drilling personnel, soil and electro-mechanical technicians for drilling and coring operations, core processing, in situ and laboratory testing. Fugro Chance (CHANCE) provided personnel and onboard surface and sub-surface navigation and positioning services.

Positioning and Vessel Operations

The MSV *Uncle John* was positioned on location using the STARFIX Differential GPS positioning system. The vessel was held on location by the use of thrusters controlled by a Cegelic DPS 902 Duplex (fully redundant) dynamic positioning (DP) system. A calibrated Sonardyne LUSBL (Long and Ultra Short Baseline) acoustic reference system was also incorporated into the vessel's DP system to determine the horizontal position of the vessel relative to a SIMRAD transponder, lowered to subsurface operations. Changes in position were monitored by a GEM80 400 PLC processor, which calculate the forces and moments necessary to restore the vessel's position. The processor controlled the pitch and orientation of six thrusters to maintain the vessel's position.

Drilling Equipment and Procedures

The MSV *Uncle John* was specially equipped for performing geotechnical field investigations in harsh environments and deep water. Drilling was performed using conventional open-hole wet rotary techniques with the drilling returns expelled at the seafloor. The mud program used to aid drilling and remove cuttings was designed and monitored by the CVX representatives onboard the vessel, and consisted of seawater, salt water gel, weighted mud, and additives (XCD polymer) to suppress gassy and expansive formation. A kill pit of weighted mud was kept ready for use to control possible kicks and shallow water flows during the drilling operations. Due to shallow flow that was encountered at the KC151#2 location, the borehole was grouted with a weak slurry mix of saltwater gel and cement. Our drilling personnel drilled the logging- and geotechnical boreholes in accordance with the specifications as outlined by the onboard CVX drilling engineer. The following paragraphs describe the drilling equipment used to complete the geotechnical field investigation at the Atwater Valley and Keathley Canyon sites.

Derrick and Rotating Equipment. The MSV *Uncle John* is equipped with a Dreco built derrick and top drive rated for 150 metric tonne hook loads. A Hydraudyne built traveling block compensator with a five-meter stroke and 150 metric tonne capacity is used. The top drive was hydraulically driven and had a maximum torque of approximately 23,000 ft-lbs. It was equipped with a unique collet for handling the drill pipe that eliminated the need to use elevators. A pipe handling system built by Dreco was also incorporated into the drilling system.

Drill String. The drill string was made up from a combination of 7.00-in.-OD, 4.00-in.-ID drill collars, 5.50-in.-OD, 4.125-in.-ID steel drill pipes and 5.50-in.-OD, 4.125-in.-ID aluminum drill pipes. For the LWD/MWD borings (AT13#1, AT14#1, KC151#2), the bottom 102.90 m (337.6-ft) of the drill string was made up from a combination of the BHA (consisting of the drill bit, and Schlumberger GeoVision Resistivity, EcoScope, TeleScope, proVision, and Azimuthal Density Tools, and crossover) and four (4) drill collars, the Schlumberger JAR, followed by another eight (8) drill collars. For the remaining four (4) soil sampling borings (AT13#2, ATM1, ATM4, KC151#3), the bottom 97.12 m (318.6-ft) of the drill string was

made up from a combination of the drill bit, a bit sub, one long and one short seal bore collar, the landing sub, driver sub 'Holland', driver sub 'Houston', and an additional nineteen (19) drill collars.

The remainder of the drill string was made up of sixty-two (62) steel and aluminum drill pipes. The borings were advanced by conventional open-hole wet rotary techniques, with drilling returns expelled at the seafloor. During the drilling operations, seawater, fresh-water gel and weighted drilling mud were used to help remove drill cuttings. Expansive and gassy formations were controlled by using XCD polymer, an additive to the weighted mud used during the drilling operations.

Coring Equipment and Procedures – Non-Pressurized Systems

The objective of the JIP coring program was aimed at the recovery of hydrate-bearing sediments for geotechnical, geochemical, geological and micro-biological testing. Four (4) coring systems were selected to provide fast, reliable, and continuous recovery of sediment material downhole. The coring systems can be categorized in two groups: Non-Pressurized and Pressurized Cores.

Fugro-Hydraulic Piston Corer (FHPC). The FHPC is a wireline-retrievable, hydraulic piston corer. The FHPC tool is designed *"...so that coring operations can be continuous, non-stop, high recovery rate and provide a nearly complete sample of the cored interval to depths in marine sediment up to 200-300 m below the seafloor. Years of use of similar tools by research and organizations have shown that the tools are rugged and reliable, require minimal maintenance, and produce core samples of marine sediments which are less disturbed than by any other known coring system."* (Assembly, Operations and Maintenance Manual for Fugro-Hydraulic Piston Corer, 2002).

A schematic of the FHPC tool is presented on [Plate A-1](#). The FHPC tool was deployed through the 4.125-in.-ID.drill pipe to take long, relatively undisturbed, non-pressurized core samples. The principle behind the tool is that stored energy inside the drill string is obtained from pressurization of the fluid column to fire the piston sampler into the soil formation by overcoming the strength of pre-selected shear pins placed in the tool. Activation pressure for the piston corer came from an auxiliary high-pressure pump or mud pump. The tool was lowered to the landing ring (Houston Landing Sub) in the Bottom Hole assembly (BHA) using the sandline, at which point the wireline blowout preventor (BOP) was closed around the sandline to isolate the inside of the drill string from the environment. The mud pumps were then started, which slowly increased the pressure in the drill string. The number of shear pins used on the FHPC determined the operating pressure required to launch the piston corer. Similarly, the adjustable control valves on the FHPC were set to regulate the stroke speed of the piston corer, depending on the stiffness of the formation encountered.

Upon reaching the operating pressure inside the drill string, the FHPC was "fired" through the drill bit and into the soil formation at a controlled stroke speed. Following penetration of the FHPC, the tool was extracted from the soil formation using the drill string, and retrieved to deck using the sandline. After recovery, the boring was advanced to the next sampling interval.

Two types of cutting shoes were utilized during the investigation. The standard cutting shoe was designed to provide optimal sample quality. The inner-diameter-to-wall-thickness – ratio of the shoe is comparable to that of geotechnical sampling tools (i.e., Shelby Tube push sample), and believed to reduce sample disturbance due to 'squeezing' and/or expansion effects caused by penetrating the soil stratigraphy. The second type of cutting shoe allows for the deployment of the Advanced Piston Corer Temperature (APCT) tool to monitor and record the temperature dissipation inside the soil formation and, hence, subsequently calculate the formation characteristic temperature gradient. The APCT system is described in greater detail in subsequent sections.

The ID of the nose cone core catcher was about 2.44-in. (62mm), while the ID of the clear plastic cellulose acetate butyrate liner was about 66 mm (2.6-in.) in diameter, leaving an annulus of about 0.08 in.

(2mm) for sample expansion as the soil passes through the core catcher into the liner. This difference in ID resulted in less radial confinement for the FHPC cores than for the geotechnical PUSH samples, which may be critical for soils where gas expansion is likely. It is difficult to assess the effects of this difference in diameter on sample expansion and, ultimately, sample quality.

Sample expansion during FHPC coring was significant, as could be expected from hydrate bearing sediments. Various control and preventive measures, in addition to the standard FHPC setup, were taken to optimize sample quality and recovery, as well as accommodate any HSE concerns. These measures included:

- Core barrel length of 30-ft while using a 25-ft stroke piston to allow sample expansion of up to 5-ft before extrusion out of the liner may occur; and
- Small pressure indicator holes within the threads of the core barrel seal sub to indicate the pressure inside the sample liner and allow for implementing preventive measure in case of any.

These measures worked with varying degree of success during the JIP campaign, and may be modified for future gas hydrate coring campaign.

Fugro Corer (FC). The Fugro Corer (FC) is a lightweight downhole hydraulic percussion coring tool for obtaining high quality cores in a range of ground conditions, ranging from very soft clays to weak rock. The Fugro Corer was developed in response to the demand for a tool capable of obtaining high quality samples of very dense, hard, and cemented soils and weak rocks. The Fugro Corer was selected as a secondary coring tool during the JIP for formations where the FHPC was incapable to operate (e.g., granular and cemented material) and/or once the FHPC threshold has been exceeded (limited or no-recovery e.g., hard clay).

The FC ([Plate A-2](#)) tool was deployed through the 4.125-in.-ID drill pipe to take long, non-pressurized core samples in formations where the FHPC would either give limited or no-recovery due to formation stiffness, or in predominantly granular stratigraphy. The activation and penetration of the FC is achieved through stored energy inside the drill string generated from pressurization of the fluid column to force the corer into the soil formation. Opposite to the shot-like penetration characteristics of the FHPC, the FC required a threshold-resistance on the corer to activate the water hammer to overcome the formation resistance and achieve penetration up to 4m (13.1-ft) ahead of the drill bit. In softer sediments where the threshold resistance was not provided, the FC operated like a hydraulically activated push corer.

After drilling the borehole to the designated coring depth, the FC was allowed to free-fall down the drill string and come to rest on the landing ring inside the Holland Seal Sub, with the core tube extending below. The drill string was then sealed off by closing the BOP, and the mud pumps were started, which slowly increased the pressure inside the drill string. Upon reaching the operating pressure inside the drill string that started the water-driven hammer mechanism, the corer was forced into the soil formation. An immediate pressure drop inside the drill string (monitored on the operator's panel on the drill floor) alerted the operator and indicated full stroke of the tool. An abrupt pressure increase would be indicative of a short stroke of the tool due to high resistance. The tool was extracted from the soil formation using the drill string, and retrieved to deck using the overshot and sandline. After recovery, the boring was advanced to the next sampling interval.

The core-cutting shoe and nose cone assembly were identical to the ones utilized during FHPC coring. The APCT tool was attempted unsuccessfully during one of the FC deployments. We believe that the hammer mechanism (i.e., vibration) caused the APCT to malfunction during deployment. The FC was also modified to utilize the identical coring barrels as the FHPC and, therefore, the same clear plastic cellulose acetate butyrate liner of 66 mm (2.6-in.)-inner-diameter. Samples obtained using the FC tool showed significantly less expansion than those obtained using the FHPC system ([Appendix C](#)). This characteristic is further discussed in subsequent paragraphs.

Sampling Equipment and Procedure – Pressurized Systems

Fugro Pressure Corer (FPC). The Fugro Pressure Corer (FPC) is a prototype coring system of the Fugro Dolphin Tool family that was made available to the CVX GoM Gas Hydrates JIP campaign through Fugro's involvement. The driving mechanism of the FPC is identical to and interchangeable with the ones of the FC. The system was developed as part of the European HYACE (Hydrate Autoclave Coring Equipment) project and incorporated an autoclave system into the Fugro Corer with the objective of sealing the core tube at ambient in situ pressure and thermal conditions.

The FPC ([Plate A-3](#)) tool was deployed through the 4.125-in.-ID drill pipe to take up to 1 m (3.3-ft) long, pressurized core samples in soft to stiff clays or sandy to gravelly material. The FPC was designed to retain a pressure of up to 25 MPa (3625 psi). The tool was lowered to the landing ring in the BHA using the sandline, at which point the wireline BOP was closed around the sandline. The mud pumps were then started, which slowly increased the pressure in the drill string. The driving and penetration characteristics of the FPC compare with those previously described for the FC. The tool was extracted from the soil formation using the drill string. The core was then retracted inside the autoclave by pulling on the wireline. Once full retraction was achieved, a flapper valve mechanism sealed the retained pressure inside the autoclave. The corer was then recovered to deck using the wireline.

A pressure sensor incorporated in the tool monitored the pressure development during coring and recovery of the system remotely, and gave a first indication of the retained pressure inside the autoclave upon recovery of the system to deck. FPC samples were not available to Fugro for any geotechnical analysis. A detailed review of the FPC system and mechanics as well as associated core processing systems (i.e., Shear Transfer Chamber) is presented in the associated report by GEOTEK (2005).

HYACE Rotary Corer (HRC). The HYACE Rotary Corer (HRC) is a prototype coring system developed by the Technical University of Berlin and the Technical University of Clausthal, Germany. The HRC uses a water-driven rotary motor (Inverse Moineau Motor) that is powered by the circulation of drilling fluids through the drill string. The HRC ([Plate A-4](#)) tool was deployed through the 4.125-in.-ID drill pipe to take 50.0 mm (1.97-in.) diameter, and up to 1 m (3.3-ft) long, pressurized core samples in soft to stiff clays or sandy to gravelly material. The HRC is designed to retain a pressure of up to 25 MPa (3625 psi). The cutting shoe of the HRC used a narrow kerf, dry auger design with polycrystalline diamond (PCD) cutting elements. This design allowed the corer to enter into the inner barrel before any flushing fluid could contaminate the material being cored. The tool was lowered to the landing ring in the BHA using the sandline, at which point the wireline BOP was closed around the sandline. The auxiliary high pressure pump was then started, which slowly increased the pressure in the drill string. The tool was extracted from the soil formation using the drill string. The core was then retracted inside the autoclave by pulling on the wireline, in a similar manner to that used for the FPC, and a specially designed flapper valve assembly sealed the pressure inside.

CTD Testing Equipment and Procedures

A Sea-Bird Electronics, Inc. (of Bellevue, Washington) SBE 19 Seacat CTD (Conductivity, Temperature and Depth) Profiler was mounted on FMMG's Halibut basket and lowered to the seafloor at boring location AT13#1, AT13#2, and KC151#3 to obtain (1) additional water depth measurement for comparison with the water depth measurements obtained using the drill string, and (2) measure conductivity, temperature and density properties of the water column. The elevation of the CTD tool, with the Halibut basket resting on the seafloor, was approximately 8 ft above the mudline. Conductivity, temperature and water density profiles from the deployment of the CTD profiler are presented in Section I of this report. The water depth measurements obtained using the CTD profiler are tabulated in Section I of this report.

The speed of sound in the water column correlated from CTD data were used to calibrate the SONARDYNE acoustic beacon that was mounted on the seabed frame and used for subsurface-positioning and secondary water depth estimates.

Advanced Piston Corer Temperature Tool

The Advanced Piston Corer Temperature (APCT) tool is a temperature data logger that logs temperature data in a deep-sea borehole (IOPD, 2004). The tool was originally designed and fitted to be deployed with IODP's Advanced Piston Corer (APC). A specially fabricated cutting shoe was used to house the APCT mounted on a cylindrical metal frame and attached to the FHPC during selected deployments. By mounting the APCT to the FHPC cutting shoe, the formation temperature and universal time could be obtained at the same time a core sample was being retrieved with only minimal time increase. Upon recovery of the FHPC to deck, the APCT was recovered from the cutting shoe and connected to a PC to download and process the recorded data. Plots of recorded data and their respective designation are presented in Section I of this report.

Water Depth Measurements

Water depths at each of the boring locations were calculated from the pipe tally. In this method, drill pipe was strung to the seafloor until the drill bit was about 10 ft above the seafloor, based on an initial water depth estimate based on bathymetric data and estimated using the ROV. The measured drill string was then lowered to the seafloor until the ROV visually indicated that the bit had contacted the soil. The estimated water depths from the soil borings are presented on the boring logs and are tabulated in Section I of this report.

Prior to running pipe operations, the CTD profiler was deployed at selected sites and an average estimate of the speed of sound in the water column was obtained and incorporated in the model used to calculate the water depth using acoustic beacon signals.

FIELD LABORATORY TESTING

All whole cores obtained from the soil boring were sealed and stored in a refrigerated cooler for subsequent onshore laboratory testing. Thirteen (13) whole core sub-sections were provided to FMMG upon completion of the field investigation for programs of conventional and advanced laboratory testing to be performed in Fugro's laboratory in Houston. The remainder of the samples were extruded from their sample tubes and visually classified by our soil technicians and geotechnical engineers concurrently with the drilling, sampling, and in situ testing operations. Representative portions of the samples, tested in the field, were packed and shipped to Fugro's laboratory in Houston for additional conventional testing. The field laboratory tests were performed in general accordance with ASTM Standards (2004) and are briefly described in the following paragraphs. Summaries of the field laboratory test results are presented in [Appendix B](#).

Classification Tests

Water Content and Density Measurements. Natural water content determinations were made for all unconsolidated-undrained (UU) triaxial compression and miniature vane test specimens, as well as for each "SAVE" tube sample. Density determinations for each extruded soil sample, including each UU triaxial compression test specimen, were made by weighing a soil sample of known volume. The data are tabulated on the Summary of Test Results, presented in [Appendix B](#), and are plotted on the boring log, presented in Section I of this report.

Carbonate Content Tests. Selected samples were tested with diluted hydrochloric acid solution (10% concentration) to obtain a qualitative assessment of the carbonate content in the sample.

Strength Tests

The undrained shear strength of cohesive samples was obtained from Torvane, pocket penetrometer, miniature vane, and unconsolidated-undrained (UU) triaxial compression tests. The results are tabulated on the Summary of Test Results (presented in [Appendix B](#)) and are plotted on the boring log in Section I.

Torvane Tests. The torvane is a small, hand-operated device consisting of a metal disc with thin, radial vanes projecting from one face. The disc is pressed against a flat surface of the soil until the vanes are fully embedded and is rotated through a torsion spring until the soil is sheared. The device is calibrated to indicate shear strength of the soil directly from the rotation of the torsion spring.

Pocket Penetrometer Tests. The pocket penetrometer is a small, hand-held device consisting of a flat-faced cylindrical plunger and spring encased in a cylindrical housing. The plunger is pressed against a flat soil surface, compressing the spring until the soil experiences a punching type bearing failure. The penetrometer is calibrated to indicate shear strength of the soil directly from compression of the spring.

Miniature Vane Tests. In performing the miniature vane test, a small, 4-bladed vane is inserted into either an undisturbed or remolded cohesive specimen. Torque is applied to the vane through a calibrated spring activated by a motorized pulley and belt system, causing the vane to rotate slowly until soil shear failure occurs. The undisturbed or remolded shear strength is computed from the torque transmitted by the calibrated spring by multiplying the rotation, in degrees, by the spring calibration factor. The maximum undrained shear strength that can be measured by the miniature vane device is approximately 3.5 ksf.

In selected undisturbed miniature vane tests, residual shear strengths of very soft to firm clay soils are also measured by allowing the vane to continue rotating after the initial soil shear failure has occurred.

The tests are terminated when the torque applied to the vane through the calibrated spring has reached a constant value. The residual shear strength, which represents the soil shear strength at large strain, is computed by multiplying the net rotation, in degrees, by the spring calibration factor.

Unconsolidated-Undrained Triaxial Compression Tests. In the unconsolidated-undrained triaxial compression test, either an undisturbed or remolded soil specimen is enclosed in a thin rubber membrane and subjected to a confining pressure. Because of the high total stresses in the sediments and the cell pressure limitation (~ 390 psi) of the triaxial set-up, confining pressures for the triaxial tests were taken as 100 psi at the mudline and increased at a rate of 1 psi for every 1-ft penetration. This methodology has, in the past, given good correlation of UU triaxial test data with miniature vane and in situ vane shear data in deepwater investigations. The test specimen is not allowed to consolidate under the influence of this confining pressure prior to and during testing. The undrained shear strength of cohesive soils is computed as one-half the maximum observed stress and are presented on the Summary of Test results in [Appendix B \(Plate B-2\)](#), and are plotted on the Logs of Boring and Test Results presented in Section I of this report. The ϵ_{50} value, percent strain at failure, and type of failure from undisturbed UU triaxial compression tests are also tabulated on the Summary of Test Results (presented in [Appendix B](#)). Selected stress-strain curves are presented in [Appendix B on Plate B-5](#).

APPENDIX A
ILLUSTRATIONS

<u>Date</u>	<u>Time</u>		<u>Description of Activities</u>
	<u>From</u>	<u>To</u>	
April 17, 2005	0000	0910	Mobilizing MSV <i>Uncle John</i> alongside Alabama State Docks, Middlebay Port, AL.
	****	0850	Pilot onboard.
	****	0910	Pushing away from dock.
	0910	2400	En-route to Atwater Valley Area.
	****	1130	Pre-Shift Safety Meeting.
	****	1500	Fire- and Lifeboat Drill, all personnel.
	****	2330	Pre-Shift Safety Meeting.
	April 18, 2005	0000	1535
****		1130	Pre-Shift Safety Meeting.
****		1200	H ₂ S safety training for essential personnel.
****		1340	Load test basket hook for van winch; Halibut basket tested to ~1600 lbs.
****		1430	H ₂ S drill, all personnel.
****		1500	H ₂ S safety training for scientific personnel.
****		1535	Near Location AT 13.
1535		1855	Vessel ballasting down.
1855		2040	DP trials.
2040		2400	Rig up to run pipe. Rig up to deploy Halibut basket with CTD, Niscan bottles and compatts in the water.
****		2050	ROV in the water.
****		2135	ROV on bottom, standing-by in TMS.
****		2150	ROV placed Compatt #1 on seafloor.
****		2208	Deployed Halibut basket with CTD, compatts, Niscan bottles and beacon to depth.
****		2312	ROV picked up and placed Compatts #2 and #3.
****		2315	ROV entangled in lifting line for Halibut basket.
****		2330	Pre-Shift Safety Meeting.
****		2350	Halibut basket recovered on deck.

SUMMARY OF FIELD OPERATIONS

Chevron Texaco Gas Hydrates JIP

Blocks 13 and 14, Atwater Valley Area – Block 151, Keathley Canyon Area
Gulf of Mexico

<u>Date</u>	<u>Time</u>		<u>Description of Activities</u>
	<u>From</u>	<u>To</u>	
April 19, 2005	0000	0415	Rig up and assemble Schlumberger LWD/MWD BHA. ROV continues dive at seabed.
	****	0125	Drill crew to abandon drill floor for Schlumberger to install nuclear source #1 in BHA.
	****	0135	OCC informs of difficulties holding position, thrusters at marginal capacities.
	****	0150	Deploy Halibut basket to depth with three (3) Niscan bottles and five (5) ROV push samplers.
	****	0225	ROV at Halibut basket, ~ 255-ft above ML.
	****	0230	Continue decent of Halibut basket to ~9-ft above ML, ROV standing-by. Re-position Vessel to support Halibut basket touchdown.
	****	0310	Trigger Niscan bottles successfully.
	****	0325	Lower basket to ML. Touchdown ~ 60-ft off location AT13#1.
	****	0335	Attempt to take ROV push core unsuccessful. T-bar lost during attempt to lift corer out of holster.
	****	0350	Take two (2) ROV push core samples successfully.
	****	0355	Attempt to take ROV push core unsuccessful. Core catcher and sample lost during attempt.
	****	0405	Take liner sampler using ROV push core liner successfully. Recover basket and ROV to deck.
	****	0430	ROV in moonpool.
	0415	0750	Run drill pipe to mudline.
	0750	0915	All stop on drill floor: Monitoring high currents (>2 kts.) that make running drill pipe difficult.
	****	0810	Deploy ROV to depth.
	0915	2045	Continue running drill pipe to mudline.
	****	1130	Pre-Shift Safety Meeting.
	****	1230	Move vessel ~ 300-ft off location to attempt USBL spin test.
	****	1505	Abort USBL spin test due to excessive currents.
	****	1805	ROV conducts drill pipe survey: Horizontal offset of drill pipe due to currents at ~ 1,000-ft below sea surface is ~40-ft.
	****	2030	Vessel moving back to position AT13#1.

SUMMARY OF FIELD OPERATIONS

Chevron Texaco Gas Hydrates JIP

Blocks 13 and 14, Atwater Valley Area – Block 151, Keathley Canyon Area
Gulf of Mexico

<u>Date</u>	<u>Time</u>		<u>Description of Activities</u>	
	<u>From</u>	<u>To</u>		
April 19, 2005 (cont.)	****	2040	ROV meets drill bit at ~35-ft above ML.	
	****	2110	Vessel on location AT13#1. Measure water depth to 4,234-ft (1,290.5m) using pipe tally, and 4,229-ft (1,289m) with ROV.	
		2110	2125	Rig up on drill floor for LWD/MWD boring.
		2125	2220	Troubleshoot rooster box: Dismantle rooster box from top drive.
		2220	2305	Continue rig up on drill floor.
		2305	2400	Drilling AT13#1 LWD/MWD boring, from ML to 60-ft (18.3m) penetration.
		****	2330	Pre-Shift Safety Meeting.
	April 20, 2005		0000	2130
		****	1130	Pre-Shift Safety Meeting.
		****	1200	Boring advanced to ~475-ft (144.8m) BML.
		****	2050	Boring advanced to ~685-ft (208.89m) BML.
		2130	2150	Troubleshooting rinsing pump unit.
		2150	2215	Continue boring operations: Sweep hole with 20 BBL gel.
		2215	2245	Troubleshooting rinsing pump unit.
		2245	2400	Continue drilling AT13#1 LWD/MWD boring, from 685-ft (208.8m) to 746-ft (227m) penetration.
		****	2330	Pre-Shift Safety Meeting.
		0000	2400	ROV in the water.
April 21, 2005			0000	0215
		0215	0325	Attempt two (2) 20 BBL sweeps and reaming; pipe resisting rotation (~20,000 lb overpull).
		0325	0845	Pull pipe to 92-ft (28.0m) above mudline.
		0845	1150	Prepare to transit to AT14#1 LWD/MWD boring location.
		****	0900	Helicopter arrives with personnel (CDI crew change).

SUMMARY OF FIELD OPERATIONS

Chevron Texaco Gas Hydrates JIP

Blocks 13 and 14, Atwater Valley Area – Block 151, Keathley Canyon Area
Gulf of Mexico

<u>Date</u>	<u>Time</u>		<u>Description of Activities</u>
	<u>From</u>	<u>To</u>	
April 21, 2005 (cont.)	****	0910	Helicopter departs from vessel with CDI crew. Deploy Halibut basket to depth to retrieve compatts and mark AT13#1 location with buoy.
	****	0947	ROV recovered compatt #1 to basket.
	****	0953	Lower basket 44-ft above mudline. ROV picks up buoy in basket.
	****	1046	Picked up compatt #2, recovered to basket
	****	1105	Picked up compatt #3, recovered to basket.
	****	1108	Recover basket to deck.
	****	1130	Helicopter arrives with personnel (CDI crew change), and FMMG parts. Pre-Shift Safety Meeting.
	****	1150	Helicopter departs from vessel with CDI crew. Halibut basket recovered to deck.
	1150	1535	Move to AT14#1 LWD/MWD boring location on DP.
	1535	1555	Rig up Halibut basket with CTD, (2) Niscan bottles, (5) push core samplers and (3) compatts.
	1555	1955	Basket in the water.
	****	1625	Basket on bottom.
	****	1626	Trigger (1) Niscan bottle.
	****	1652	ROV pick up compatt #1 and position on seafloor.
	****	1723	ROV pick up compatt #2 and position on seafloor.
	****	1746	ROV pick up compatt #3 and position on seafloor.
	****	1800	ROV move basket to AT14#1 location.
	****	1806	ROV pick up sampler #1 from basket.
	****	1814	Push sampler #1 into seafloor. Liner breaks during recovery. Decided to abort push sampling operations.
	****	1848	Lower drill pipe to mudline.
	****	1905	Drill bit near mudline.
	****	1906	Vessel DP alarm on Thruster #9 and #10. No station keeping redundancy. Pick up drillpipe to 10 ft (3m) above mudline. Waiting on weather.
	****	1915	Recover basket to deck.
	****	1950	Basket recovered to deck.

SUMMARY OF FIELD OPERATIONS

Chevron Texaco Gas Hydrates JIP

Blocks 13 and 14, Atwater Valley Area – Block 151, Keathley Canyon Area
Gulf of Mexico

<u>Date</u>	<u>Time</u>		<u>Description of Activities</u>
	<u>From</u>	<u>To</u>	
April 21, 2005 (cont.)	1950	2130	Standing-by: Vessel experiencing current force of 43-tons from west.
	2130	2400	Deploy basket to depth. Conduct seafloor sampling using ROV.
	****	2130	Instructed by CVX Rep. to rig up basket with (2) Niscan bottles and (5) push core samplers.
	****	2157	Basket in the water.
	****	2227	ROV at basket location.
	****	2258	ROV push Sampler #3 into seafloor.
	****	2304	ROV push Sampler #4 into seafloor.
	****	2323	ROV push Sampler #5 into seafloor.
	****	2330	Pre-Shift Safety Meeting.
	****	2357	ROV push Sampler #1 into seafloor.
		0000	2400
April 22,2005	0000	0034	Continue seafloor sampling using ROV.
	****	0012	ROV pushes Sampler #2 into seafloor.
	****	0023	Reposition basket near AT14#1 LWD/MWD boring location using ROV.
	****	0034	ROV triggers Niscan bottle at 10-ft (3m) above mudline near AT14#1 location. Recover basket to deck.
	0034	0110	Standing-by: No redundancy in station keeping capacity.
	0110	0700	Resume drilling operation at AT14#1 LWD/MWD boring location.
	****	0110	Basket with soil and Niscan bottles recovered to deck.
	****	0115	Vessel on position. Measure water depth to 4,266-ft (1,300.3m) using pipe tally and ROV observation and 4,255-ft (1,296.9m) using ROV sensor.
	****	0125	Commence drilling at AT14#1 LWD/MWD boring from mudline to 222-ft (67.7m) penetration.
	0700	0745	Troubleshooting rinsing pump unit.
	0745	2400	Re-commence drilling at AT14#1 LWD/MWD boring from 222-ft (67.7m) to 744-ft (227.0m) penetration.

SUMMARY OF FIELD OPERATIONS

Chevron Texaco Gas Hydrates JIP

Blocks 13 and 14, Atwater Valley Area – Block 151, Keathley Canyon Area
Gulf of Mexico

<u>Date</u>	<u>Time</u>		<u>Description of Activities</u>
	<u>From</u>	<u>To</u>	
April 22, 2005 (cont.)			from 222-ft (67.7m) to 714-ft (217.6m) penetration.
	****	1130	Pre-Shift Safety Meeting.
	****	1218	Crew boat M/V Gilbert McCaw alongside vessel, offloading barite, salt gel and XCD.
	****	1332	Crew boat MS Gilbert departing location.
	****	1945	Instructed to rig up basket with push sampling equipment.
	****	2020	Deploy basket to depth.
	****	2050	Basket ~10-ft off bottom, standing-by.
	****	2115	Completed ROV seafloor survey in vicinity of drillstring.
	****	2135	ROV at basket, taking basket to bottom; obtain ROV push samples in boring vicinity.
	****	2320	ROV back at drill string. Basket coming back up to deck.
	****	2330	Pre-Shift Safety Meeting.
	****	2355	Basket recovered to deck.
		0000	2400
April 23, 2005	0000	0955	Continue drilling AT14#1 LWD/MWD boring, from 714-ft (217.6m) to 940-ft (286.5m) penetration.
	****	0930	Rig up basket to deploy buoy marker and retrieve compatts.
	****	0955	Complete boring at total depth of ~940-ft (286.5m) BML.
	0955	1025	Run mud sweep in hole.
	****	1020	Basket stops at ~60-ft (18.3m) above mudline.
	1025	1310	Pull pipe out of hole and above mudline.
	****	1130	Pre-Shift Safety Meeting.
	****	1115	ROV moves from touchdown point to retrieve Compatt #1. Drillfloor crew performing Blowout Response Drill with use of TIW valve.
	****	1120	ROV picks up Compatt #1.
	****	1156	ROV places Compatt #1 on basket clamp and picks up mudline buoy.

SUMMARY OF FIELD OPERATIONS

Chevron Texaco Gas Hydrates JIP

Blocks 13 and 14, Atwater Valley Area – Block 151, Keathley Canyon Area
Gulf of Mexico

<u>Date</u>	<u>Time</u>		<u>Description of Activities</u>
	<u>From</u>	<u>To</u>	
April 23, 2005 (cont.)			up marker buoy.
	****	1225	Crew boat M/V Gilbert McCaw arrives on location. Sea conditions too rough for taking off cargo; standing-by and waiting on weather.
	****	1235	ROV picks up Compatt #2 and places on basket.
	****	1240	Recover basket with two (2) compatts to deck.
	****	1310	Basket on deck.
	1310	1405	Lift aluminum drill pipe on pipe rack.
	1405	1700	Continue pulling pipe out of hole.
	****	1700	Vessel's feeding pump malfunctions.
	1700	1830	Standing-by for CDI to troubleshoot feeding pump.
	1830	2045	Pull pipe out of hole at slow speed while re-logging the top ~120-ft of the borehole using Schlumberger's LWD/MWD.
	****	2045	Drill pipe ~30-ft above bottom. CDI to offload cargo from M/V Gilbert McCaw.
	2045	2245	Standing-by: CDI crew offloading cargo from M/V Gilbert McCaw.
	****	2120	ROV picks up Compatt #3 off seabed.
	****	2216	ROV performing visual seafloor survey in borehole vicinity.
	****	2240	ROV coming up to ~1000-ft below surface with compatt.
	2245	2400	Continue pulling pipe to deck.
	****	2255	Vessel starting to move on DP towards AT13 boring location.
	****	2315	Continuous problems setting slips on drill floor due to currents, vessel and crane movements.
	****	2330	Pre-Shift Safety Meeting.
	****	2335	Stop transit to AT13 boring location. Correcting ballast of vessel to accommodate drill floor operations.
	****	2400	Bit at 3,966-ft below deck.
	0000	2400	ROV in the water.

SUMMARY OF FIELD OPERATIONS

Chevron Texaco Gas Hydrates JIP

Blocks 13 and 14, Atwater Valley Area – Block 151, Keathley Canyon Area
Gulf of Mexico

<u>Date</u>	<u>Time</u>		<u>Description of Activities</u>	
	<u>From</u>	<u>To</u>		
April 24, 2005	0000	1135	Continue pulling pipe to deck.	
	****	0105	Drill pipe ~780-ft (237.7m) above mudline.	
	****	0215	Drill pipe ~1180-ft (359.7m) above mudline.	
	****	0230	Prepare to lower basket to retrieve last Compatt.	
	****	0240	Basket in the water.	
	****	0247	Lower basket to 1000-ft (304.8m) water depth.	
	****	0312	ROV places Compatt #3 on basket. Recover basket with 1 Compatt to deck.	
	****	0325	Basket back on deck. Drill pipe ~1722-ft (524.9m) above mudline.	
	****	0335	ROV back on deck.	
	****	0430	Vessel starts moving slowly (~0.1 knot) back to AT13 boring location. Drill pipe ~2309-ft (703.8m) above mudline.	
	****	0545	Drill pipe ~2935-ft (894.6m) above mudline.	
	****	0755	All drill pipe on deck, pulling collars and LWD BHA.	
	****	0920	Drill crew abandons drill floor for Schlumberger to remove nuclear source #1 from BHA.	
	****	0945	Radioactive source placed into protective storage.	
	****	1105	Begin loading/offloading cargo to/from the M/V Gilbert McCaw.	
	****	1135	All drill pipe, collars and Schlumberger LWD BHA back on deck. Vessel electrician/engineers troubleshooting top drive compensator electronics.	
		1135	1150	Schlumberger removing nuclear source #2 from BHA on deck. Rig up basket with S4 current meter.
		1150	1215	Cargo transfer from/to M/V Gilbert McCaw, crew boat remaining on stand-by.
		1215	1300	Standing-by for Schlumberger to download data from LWD BHA.
	****	1239		Stop loading/offloading operations. M/V Gilbert McCaw standing-by. Vessel starting to move to WSW on DP.
	1300	1330	Re-rigging basket with S4 current meter onboard.	

SUMMARY OF FIELD OPERATIONS

Chevron Texaco Gas Hydrates JIP

Blocks 13 and 14, Atwater Valley Area – Block 151, Keathley Canyon Area
Gulf of Mexico

<u>Date</u>	<u>Time</u>		<u>Description of Activities</u>
	<u>From</u>	<u>To</u>	
April 24, 2005 (cont.)	1330	1420	Deploy basket to ~2,000-ft below surface to record current profile.
	1420	1622	Rig up on drill floor,
	****	1400	Troubleshooting drill rig's compensator completed.
	****	1420	Basket with S4 current meter recovered to deck. No data recorded.
	****	1438	Vessel begins to move towards WSW from AT13#2 to accommodate currents during pipe running.
	1622	1631	Standing-by, vessel stops: CDI offloading/loading cargo to/from M/V Gilbert McCaw.
	****	1637	Vessel continues to move WSW from AT13#2 to accommodate currents during running pipe operations.
	1631	1827	Continue rigging on drill floor. Lifting reaction mass on drill floor and installing in moonpool on spider beams.
	1827	2045	Standing-by, vessel stops: CDI offloading/loading cargo to/from M/V Gilbert McCaw.
	2045	2245	Continue rigging on drill floor: Making up BHA.
	2245	2335	Lower BHA through reaction mass and install bit locks.
	****	2335	Client advised to stop vessel short of target up-current position, start lowering pipe while beginning controlled drift.
	2335	2350	Waiting for green light to start subsurface operations. Vessel stopping and going into controlled drift.
	2350	2400	Lower reaction mass of spider beams and start running pipe.
	April 25, 2005	0000	0335
0335		2400	Perform servicing on ROV and troubleshoot sonar system.
0000		0440	Continue to lower reaction mass and run pipe to 1530-ft (466.3m) water depth.
****		0015	Verified ROV pressure supplied for hot stab on reaction mass sea clamp system. Pressure set to 1,500 psi.
****		0230	Run pipe to ~821-ft (250.2m) water depth.

SUMMARY OF FIELD OPERATIONS

Chevron Texaco Gas Hydrates JIP

Blocks 13 and 14, Atwater Valley Area – Block 151, Keathley Canyon Area
Gulf of Mexico

<u>Date</u>	<u>Time</u>		<u>Description of Activities</u>
	<u>From</u>	<u>To</u>	
April 25, 2005 (cont.)	****	0310	ROV in the water.
	****	0400	Run pipe to ~1417-ft (431.9m) water depth. Vessel in controlled drift at ~0.25 knots, 3.5NM WSW of location.
	0440	0730	Rig up and conduct FHPC pipe test at 1530-ft (466.3m) water depth.
	****	0507	Troubleshoot burst host on HP mud pump system.
	****	0630	Lower FHPC to depth.
	****	0650	Launch FHPC successfully. Fired at 1,300 psi with two (2) AL-pins.
	****	0710	FHPC back on deck. Vessel 2.7NM off location.
	0730	1020	Resume running pipe from 1530-ft (466.3m) water depth to 2719-ft (828.8m) water depth.
	****	1000	Run pipe to ~2628-ft (801.0m) water depth.
	1020	1340	Stand-by for repairs on bearings of top drive rails.
	****	1130	Pre-Shift Meeting.
	1340	1625	Continue running drill pipe to mudline.
	****	1515	On location: Lower basket with two (2) compatts onboard to seabed.
	****	1550	Survey begins spin test for USBL system.
	****	1600	Recover basket back to deck. ROV placed two (2) compatts on deck.
	1625	1745	Stand-by on drill floor for completion of spin test. Bit at ~4,060-ft (1,237.5m) below deck.
	****	1630	Basket recovered to deck.
	1745	1835	Rigging up rooster box on drill floor.
	****	1810	On location AT13#2.
	1835	1845	Continue running drill pipe to mudline.
	1845	1855	Set up drill floor for sampling and drilling.
	1855	1915	All stop on drill floor: ROV tether entangled around drill string. Standing-by.
	1915	1945	Continue running drill pipe to mudline.
	****	1945	Measure water depth to 4,236-ft using pipe tally and ROV observation.

SUMMARY OF FIELD OPERATIONS

Chevron Texaco Gas Hydrates JIP

Blocks 13 and 14, Atwater Valley Area – Block 151, Keathley Canyon Area
Gulf of Mexico

<u>Date</u>	<u>Time</u>		<u>Description of Activities</u>	
	<u>From</u>	<u>To</u>		
April 25, 2005 (cont.)	1945	2015	Lift FHPC and FPC corers into mouseholes on drill floor.	
	2015	2030	JSA Toolbox Meeting on the drill floor: General D&S Operations, Special Tools.	
	2030	2050	Rig up to lower FHPC to depth.	
	2050	2215	Deploy FHPC to mudline.	
	****	2120	FHPC at bit.	
	****	2135	FHPC pre-sheared during decent. Recover to deck. Overshot pulled off tool various times.	
	****	2155	FHPC pulled out of mud using bit. Recover to deck with overshot.	
	****	2215	Tool dropped during ascent to deck. Recovered overshot, change overshot head.	
	2215	2345	Deploy overshot to depth to recover FHPC tool.	
	****	2330	Pre-Shift Meeting.	
	****	2245	Lost FHPC during ascent at ~1,500-ft below surface.	
	****	2345	FHPC recovered to deck successfully.	
	2345	2400	Recover FHPC liner to deck and into processing container. Re-rig corer for next deployment.	
	April 26, 2005	0000	0125	Troubleshoot drill pipe and FPHC for pre-firing. Vessel moves over ~15-ft NE to re-initiate boring, and re-rig next corer.
		****	0120	Vessel at new location.
0125		0255	Deploy FHPC 1H to ~6-ft (1.8m) above mudline.	
****		0220	Troubleshoot high pressure water pump (no build up of pressure).	
****		0240	Fire FHPC 1H, and commence recovery.	
0255		0355	All stop. Troubleshoot relief valve on sandline winch.	
0355		0430	Recover FHPC 1H to deck. Total recovery = 23-ft (7.0m).	
0430		0545	Boring advanced to ~23-ft (7.0m) BML and rig up FHPC 2H with temperature tool.	
0545		0730	Deploy FHPC 2H at ~23-ft (7.0m) BML.	

SUMMARY OF FIELD OPERATIONS

Chevron Texaco Gas Hydrates JIP

Blocks 13 and 14, Atwater Valley Area – Block 151, Keathley Canyon Area
Gulf of Mexico

<u>Date</u>	<u>Time</u>		<u>Description of Activities</u>
	<u>From</u>	<u>To</u>	
April 26, 2005 (cont.)	****	0634	FHPC 2H at mudline, waiting for three minutes for temperature measurement.
	****	0644	No pressure built-up from high-pressure water pump; switch to mud pump. Ran out of memory on FHPC 2H temperature tool.
	****	0655	Fire FHPC 2H, and commence recovery.
	0730	0800	Recover FHPC 2H to deck. Total recovery = 28-ft (8.5m).
	0800	1007	Standing-by. Awaiting vessel to provide water pressure to restart mud pump. DP informs us that thrusters 9 and 10 are running at 90%. Troubleshoot high pressure water pump.
	****	0955	ROV releases bit locks on seabed frame reaction mass. Seabed frame on seafloor.
	****	1007	OCC gives green light to recommence drilling operation.
	1007	1205	Recommence drilling from 23-ft (7.0m) to 51-ft (15.5m) BML.
	****	1039	Boring advanced to ~51-ft (15.5m) BML and lower FPC 3P.
	****	1055	ROV positions over to clamp drill pipe. FPC 3P lands on bit at ~51-ft (15.5m) BML.
	****	1100	Rig up FHPC 4H with Temperature tool. ROV hot stab to 1500 psi. Chopper lands on vessel for CDI crew change.
	****	1112	FPC 3P on bit (51-ft BML).
	****	1120	Fire FPC 3P, and commence recovery.
	****	1205	All stop on drillfloor. Thrusters up to 60 tons.
	1205	1345	Standing-by on weather.
	****	1240	Recover FPC 3P to deck. Total recovery = 9-ft (2.7m).
	****	1345	Green light to recommence drilling operation.
	1345	1400	Standing-by on Rig; troubleshooting generators.
	1400	1445	Recommence drilling from 51-ft (15.5m) to 60-ft (18.3m) BML.
	1445	1650	Deploy FHPC 4H to 60-ft (18.3m) BML.
****	1525	FHPC 4H on bottom.	

SUMMARY OF FIELD OPERATIONS

Chevron Texaco Gas Hydrates JIP

Blocks 13 and 14, Atwater Valley Area – Block 151, Keathley Canyon Area
Gulf of Mexico

<u>Date</u>	<u>Time</u>		<u>Description of Activities</u>	
	<u>From</u>	<u>To</u>		
April 26, 2005 (cont.)	****	1535	Fire FHPC 4H, and leave tool in formation for temperature data acquisition.	
	****	1550	Commence recovery of FHPC 4H.	
	****	1615	Recover FHPC 4H to deck. Total recovery = 28-ft (8.5m). Chopper lands on vessel for CDI crew change.	
	1650	1740	Drill from 60-ft (18.3m) to 89-ft (27.1m) BML.	
	1740	1930	Deploy HRC 5R to 89-ft BML.	
	****	1820	HRC 5R on bottom. ROV moves over to close clamp on reaction mass.	
	****	1835	Close clamps, and fire HRC 5R.	
	****	1930	Recover HRC 5R to deck. Total recovery = 3.9-ft (1.2m).	
	1930	2025	Rig down HRC and drill to 94-ft (28.7m) BML.	
	2025	2200	Deploy FHPC 6H to 94-ft (28.7m) BML.	
	****	2120	Fire FHPC 6H and commence recovery.	
	****	2200	Recover FHPC 6H to deck. Total recovery = 30-ft (9.1m).	
	2200	2315	Drill to 124-ft (37.8m) and rig up FPC 7P.	
	2315	2400	Deploy FPC 7P to 124-ft (37.8m) BML.	
	****	2345	ROV moves over for hot stab.	
	****	2400	Close clamps to fire FPC 7P.	
		0000	2400	ROV in the water.
	April 27, 2005	0000	0030	Continuing deployment of FPC system to 124-ft (38.8m) BML.
****		0020	Launched FPC 7P at 124-ft (38.8m) BML.	
0030		1855	All Stop. Black-out on drillfloor: Troubleshoot electrical problem on driller's panel and topdrive.	
****		0110	Recovering FPC 7P to deck.	
****		0900	Helicopter lands and departs.	
****		0915	Helicopter arrives with MMS personnel and inspectors.	

SUMMARY OF FIELD OPERATIONS

Chevron Texaco Gas Hydrates JIP

Blocks 13 and 14, Atwater Valley Area – Block 151, Keathley Canyon Area
Gulf of Mexico

<u>Date</u>	<u>Time</u>		<u>Description of Activities</u>
	<u>From</u>	<u>To</u>	
April 27, 2005 (cont.)	****	1015	JSA toolbox meeting: Mounting of wireline sheave for piezoprobe testing.
	****	1030	Mounting wireline crown sheave on derrick.
	****	1240	M/V Gilbert McCall alongside.
	****	1245	Unloading cargo, one (1) CDI personnel boarding rig.
	****	1415	Helicopter with MMS personnel departs.
	****	1533	Recovering ROV to deck.
	****	1605	H ₂ S drill for all personnel.
	****	1656	Helicopter arrives with parts for topdrive.
	****	1700	Helicopter departs.
	****	1810	Continuing to backload M/V Gilbert McCall.
	****	1835	M/V Gilbert McCall departs.
	****	1855	Completed repairs on topdrive. Drill floor back on line.
	1855	2000	Drill to 130-ft (39.6m) BML.
	****	1915	Deploying ROV to depth.
	2000	2130	Deploying and recovering FHPC 8H to/from 130-ft (39.6m) BML.
	****	2010	M/V Gloria B Callais alongside.
	****	2030	Fired FHPC 8H, standing-by for APCT data acquisition at 153-ft (46.6m) BML.
	****	2045	Pull FHPC 8H out of formation.
	****	2107	Recover FHPC 8H on deck. Total recovery 23-ft (7.0m).
	2130	2230	Drilling down to ~158-ft (48.2m) BML.
	****	2230	Black-out on drillfloor.
	2230	2325	Troubleshooting topdrive.
	2325	2400	Continue drilling from 158-ft (48.2m) to 170-ft (51.8m) BML.
April 28, 2005	0000	0050	Continue drilling from 170-ft (51.8m) to 202-ft (61.6m) BML.
	0050	0555	All Stop on drill floor: Troubleshooting mud pump (replace oil line).
	****	0215	Place FHPC 9H into mousehole.

SUMMARY OF FIELD OPERATIONS

Chevron Texaco Gas Hydrates JIP

Blocks 13 and 14, Atwater Valley Area – Block 151, Keathley Canyon Area
Gulf of Mexico

<u>Date</u>	<u>Time</u>		<u>Description of Activities</u>
	<u>From</u>	<u>To</u>	
April 28, 2005 (cont.)	****	0230	Rig up fuel hoses for refueling operation. M/V Gloria B Callais alongside.
	****	0315	Begin refueling operations.
	****	0555	Electrical problem on topdrive. Pull bit off bottom to 108-ft (32.9m) BML.
	0555	0915	All stop on drill floor: Troubleshooting mud pump and topdrive.
	****	0742	Complete refueling.
	****	0820	Topdrive back on line.
	****	0830	Charging up oil in mud pump oil line.
	0915	1620	Continue drilling operations from 108-ft (32.9m) BML to 416-ft (126.8m) BML.
	****	1100	Boring advanced to ~170-ft (51.8m) BML.
	****	1300	Helicopter arrives; six (6) personnel on; six (6) personnel off.
	****	1305	Helicopter departs.
	1620	1725	Deploy FHPC 9H to 388-ft (118.3m) BML.
	****	1625	Lowering FHPC 9H to depth.
	****	1655	Fire FHPC 9H.
	****	1725	Recover FHPC 9H to deck. Total recovery = 9-ft (2.7m).
	1725	1835	Boring advanced to ~414-ft (126.2m) BML.
	1835	2012	Deploy HRC 10R to 414-ft (126.2m) BML.
	****	1915	HRC 10R on bottom. ROV positions in to activate sea clamp.
	****	1925	Sea clamp activated.
	****	1927	Pressurized drill pipe and rotate HRC 10R to depth.
	***	1930	HRC sampling completed. ROV releases sea clamp.
	****	1942	Opening sea clamp and recover HRC 10R.
	****	2012	Recovered HRC 10R to deck. No recovery.
	2012	2040	Boring advanced to ~416-ft (126.8m) BML. Deploy FHPC 11H to 416-ft (126.8m) BML.
	2040	2220	Troubleshooting FHPC piston.
	****	2145	Fixed piston rod. Make up new FHPC barrel.

SUMMARY OF FIELD OPERATIONS

Chevron Texaco Gas Hydrates JIP

Blocks 13 and 14, Atwater Valley Area – Block 151, Keathley Canyon Area
Gulf of Mexico

<u>Date</u>	<u>Time</u>		<u>Description of Activities</u>
	<u>From</u>	<u>To</u>	
April 28, 2005 (cont.)	2220	2400	Continue to deploy FHPC 11H to 416-ft (126.8m) BML.
	****	2310	Fired FHPC 11H.
	****	2400	All Stop. Topdrive electrical problems. FHPC 11H recovered to deck.
	0000	2400	ROV in the water.
April 29, 2005	0000	0430	Troubleshoot electrical problem on topdrive.
	****	0015	FHPC 11H out of drillpipe.
	****	0050	Liner ruptured inside barrel. Lost bottom 10-ft (3.1m) of FHPC 11H.
	0430	0610	Resume drilling from 416-ft (126.8m) to 440-ft (134.1m) BML.
	0610	0700	Deploy FPC 12P to 440-ft (134.1m) BML.
	****	0635	FPC 12P on bottom. Pressurize drillpipe to launch FPC 12P. Commence recovery.
	****	0715	Recover FPC 12P on deck. Lower 33-ft (10m) section of FPC lost in drillpipe.
	0715	1100	All stop. Rig up fishing tool for FPC.
	1100	1340	Commence recovery operation for FPC.
	****	1115	Lower fishing tool for FPC.
	****	1145	Fishing tool on bottom.
	****	1155	Sandline winch pulls 8,300 lbs before slacking off to 3,300 lbs.
	****	1200	Commence retrieving fishing tool.
	****	1245	Fishing tool and FPC on deck.
	1340	1450	Resume drilling from 440-ft (134.1m) to 463-ft (141.1m) BML.
	1450	1650	Deploy FHPC 13H to 463-ft (141.1m) BML.
	****	1457	Lower FHPC 13H to depth.
****	1545	Fire FHPC 13H and measure temperature at 488-ft (148.7m) BML.	
****	1600	Commence recovery of FHPC 13H.	

SUMMARY OF FIELD OPERATIONS

Chevron Texaco Gas Hydrates JIP

Blocks 13 and 14, Atwater Valley Area – Block 151, Keathley Canyon Area
Gulf of Mexico

<u>Date</u>	<u>Time</u>		<u>Description of Activities</u>	
	<u>From</u>	<u>To</u>		
April 29, 2005 (cont.)	****	1630	Recover FHPC 13H on deck. Total recovery =29-ft (8.8m), but 3.3 m stuck in core barrel.	
		1650	1730	Boring advanced to ~493-ft (150.3m) BML.
		1730	1830	Rig up FHPC 14H.
		1830	1935	Deploy FHPC 14H to 493-ft (150.3m) BML.
	****	1855		FHPC 14H on bottom. Fire FHPC 14H and commence recovery.
	****	1935		Recover FHPC 14H on deck.
		1935	2155	Rig up piezoprobe tool for Piezoprobe 15PI.
	****	2045		Boring advanced to ~517-ft (157.6m) BML.
	****	2140		JSA toolbox meeting for handling piezoprobe tool.
		2155	2215	Assemble piezoprobe tool in drillstring.
	****	2158		Configure piezoprobe tool in drillstring. Lift bit 40-ft (12.2m) off bottom.
		2215	2400	Deploy Piezoprobe 15PI to depth.
	****	2328		Piezoprobe 15PI at 4,440-ft (1353.3m) water depth.
	****	2353		Piezoprobe 15PI on bottom of bit.
	****	2359		Take hydrostatic pressures at 515-ft (157.0m) BML.
		0000	2400	ROV in the water.
	April 30, 2005		0000	0315
****		0005		Lower piezoprobe tool 10-ft (3.3m) into BHA. No push.
****		0016		Lift piezoprobe tool up 10-ft (3.3m) and lower again 10-ft (3.3m). No push.
****		0023		Lift piezoprobe tool up 15-ft (4.6m).
****		0031		Lift piezoprobe tool up another 10-ft (3.3m) and lower 25-ft (7.6m) into BHA.
****		0040		Piezoprobe on bottom. Still no push. Lift drillpipe as high as possible.
****		0050		Lower tool to bottom. Still no push.
****		0055		Commence recovery of piezoprobe tool.
		0315	0715	Piezoprobe tool back on deck. Recommence drilling from 517-ft (157.0m) to 631-ft (192.3m) BML.

SUMMARY OF FIELD OPERATIONS

Chevron Texaco Gas Hydrates JIP

Blocks 13 and 14, Atwater Valley Area – Block 151, Keathley Canyon Area
Gulf of Mexico

<u>Date</u>	<u>Time</u>		<u>Description of Activities</u>
	<u>From</u>	<u>To</u>	
April 30, 2005 (cont.)	****	0545	Unable to assemble 15-ft FHPC tool as piston rods are too thick. Client green lights the use of a 25-ft FHPC.
	****	0625	Rig up 25-ft FHPC on drill floor.
	****	0635	Piston rod jammed in 25-ft FHPC.
	****	0645	Lift 25-ft FHPC with jammed piston rod off drill floor. Troubleshoot 25-ft FHPC.
	0715	0750	Boring advanced to ~631-ft (192.3m) BML. Continue to troubleshoot 25-ft FHPC.
	****	0750	Client decision to skip FHPC test and continue with program.
	0750	0900	Boring advanced to ~656-ft (199.9m) BML.
	0900	1200	Run sweep at boring depth and trip pipe to 515-ft (157.0m) BML.
	1200	1445	Pull bit up 35-ft (10.7m) to 480-ft (146.3m) BML.
	****	1445	Hang pipe on bit locks of reaction mass.
	1445	1630	Attempt to free lift locks. Rig Schlumberger wireline tool on drill floor.
	****	1528	ROV closes clamps.
	****	1536	ROV attempts to open clamps but fails to do so. Observe oil leaking from re-entry funnel.
	****	1604	ROV removes from hotstab and pressurizes remaining clamps. Clamps closed.
	1630	1815	Rig up top sheave for Schlumberger logging tool.
	****	1640	Use hotstab system to release clamps; switch valves but unsuccessful in releasing clamps. Vegetable oil still leaking.
	1815	1845	Rig up to lift Schlumberger lifting tool.
	1845	1930	Standing-by. Schlumberger lifting tool will not work in rooster box while compensator is active.
	****	1915	Houston office responds on how to open clamps. ROV to position in to break hoses off sea clamp.
	****	1930	ROV breaks hydraulic hoses. Clamps open.
	1930	2020	Continue to rig up Schlumberger lifting tool.
	2020	2210	Commence Schlumberger wireline logging.
	****	2020	Schlumberger wireline tool goes down drillpipe.

SUMMARY OF FIELD OPERATIONS

Chevron Texaco Gas Hydrates JIP

Blocks 13 and 14, Atwater Valley Area – Block 151, Keathley Canyon Area
Gulf of Mexico

<u>Date</u>	<u>Time</u>		<u>Description of Activities</u>
	<u>From</u>	<u>To</u>	
April 30, 2005 (cont.)	****	2210	Schlumberger wireline tool back on deck. Unable to pass through the bit.
	2210	2245	Evaluate options to run wireline.
	****	2245	ChevronTexaco decide to lower tool through the mousehole and re-entry funnel into the boring.
	2245	2400	Lower Schlumberger wireline tool into the water.
	****	2310	Trip drillpipe above mudline.
	0000	2400	ROV in the water.
May 1, 2005	0000	0145	Continue to lower Schlumberger wireline tool.
	0145	0425	Schlumberger wireline tool in re-entry funnel. Commence logging.
	****	0425	Schlumberger wireline tool only able to log about 66-ft (20m) due to squeezing of the hole.
	0425	0600	ROV commences recovery to deck to troubleshoot manipulators and lamp lights.
	****	0440	ROV observes that the Schlumberger wireline tool may be wrapped around drillstring.
	****	0600	ROV back on deck.
	0600	0710	Commence recovery of Schlumberger wireline tool.
	****	0710	Schlumberger wireline tool back in mousehole.
	0710	0745	Commence dismantling of Schlumberger wireline tool.
	0745	0800	Lower drillpipe just above seabed frame.
	0800	0835	Standing-by. Awaiting ROV deployment.
	0835	0845	Helicopter arrives for crew change.
	0845	1135	ROV deployed and commence recovery of compatts.
	****	0920	Lower basket to depth. ROV on bottom.
	****	0935	Malfunction of beacon on basket. Recovery of basket from ~1,500-ft (457.2m) water depth.
	****	0945	Replace beacon and lower basket again.
****	1022	Basket at ~3,900-ft (1188.7m) water depth.	
****	1040	Lower basket to ~4,100-ft (1249.7m) water depth. ROV locates basket.	

SUMMARY OF FIELD OPERATIONS

Chevron Texaco Gas Hydrates JIP

Blocks 13 and 14, Atwater Valley Area – Block 151, Keathley Canyon Area
Gulf of Mexico

<u>Date</u>	<u>Time</u>		<u>Description of Activities</u>
	<u>From</u>	<u>To</u>	
May 1, 2005 (cont.)	1135	1210	Re-enter drillpipe into seabed frame.
	1210	1230	ROV closes bit locks on seabed frame.
	1230	1240	Lift seabed frame off bottom.
	****	1235	Pressurize compensators.
	1240	1305	Commence pulling pipe to deck. ROV follows seabed frame up to surface.
	****	1305	ROV moves in to inspect proper installation of bit locks. Seabed frame comes loose and freefalls down to seabed during inspection of bit locks.
	1305	2400	Standing-by. Recovering seabed frame from mudline.
	****	1311	Inspect drill bit and lugs on seabed frame.
	****	1350	Seabed frame on bottom and partially buried on the side.
	****	1421	ROV returns to TMS.
	****	1450	ROV returns to surface to rig up for seabed frame recovery operation. Continue to trip pipe.
	****	1533	ROV back on deck.
	****	1715	Fabricate butterfly recovery tool for seabed frame recovery operation.
	****	1838	ROV deployed.
	****	1855	Rig up butterfly recovery tool.
	****	1910	Lower butterfly recovery tool to depth.
	****	2012	ROV 60-ft (18.3m) off bottom, with butterfly recovery tool.
	****	2023	Lower drillpipe.
	****	2143	Hook up one lifting line on funnel using sheet panel latch.
	****	2308	Seabed frame lifted to ~15° tilt.
****	2346	Attach second lifting line on funnel.	
May 2, 2005	0000	0825	Recovering seabed frame (SBF) from seabed.
	****	0040	Attempt to lower drill pipe into re-entry funnel of SBF.
	****	0117	ROV opening bit locks and guiding drill string into the funnel.
	****	0155	Sea clamps on one side closed up.

SUMMARY OF FIELD OPERATIONS

Chevron Texaco Gas Hydrates JIP

Blocks 13 and 14, Atwater Valley Area – Block 151, Keathley Canyon Area
Gulf of Mexico

<u>Date</u>	<u>Time</u>		<u>Description of Activities</u>
	<u>From</u>	<u>To</u>	
May 2, 2005 (cont.)	****	0212	Lifting drill pipe out of funnel.
	****	0220	ROV attempting to open clamps.
	****	0300	ROV releasing lifting line on SBF funnel.
	****	0407	Attempt to lower drill pipe into re-entry funnel of SBF.
	****	0524	ROV slinging lifting lines around funnel as pad eyes on SBF are too small for ROV hooks to latch onto.
	****	0548	Drill pipe pulled out of funnel.
	****	0554	SBF lifted ~ 10-ft above mudline, move ~40-ft away from current location to set SBF back down straight.
	****	0612	Lower SBF down on seafloor.
	****	0624	Drill string inside SBF funnel.
	****	0645	ROV engaging bit locks on SBF.
	****	0700	ROV hooking second lifting sling on SBF flange.
	****	0825	Sandline removed from recovery tool and pulled to deck.
	0825	1710	Pulling pipe to deck with SBF hanging on bit locks of BHA.
	****	1130	Pre-Shift Safety Meeting.
	****	1540	ROV back on deck.
	****	1710	SBF lowered onto spider beams inside moonpool.
	1710	1830	Rigging down slings and other recovery systems. Inspect SBF for damage.
	1830	1950	Recover remaining drill collars and BHA to deck.
	1950	2400	Troubleshooting SBF hot stab system and bit lock assembly.
	****	2025	Move to AT14#2 site on DP.
	****	2200	On location AT14#2.
	****	2330	Pre-Shift Safety Meeting.
	May 3, 2005	0000	0430
0430		0620	Perform hydraulic deck test for sea clamp system.
0620		0730	Re-assemble seabed frame.
****		0625	Lift guide funnel section into moonpool.

SUMMARY OF FIELD OPERATIONS

Chevron Texaco Gas Hydrates JIP

Blocks 13 and 14, Atwater Valley Area – Block 151, Keathley Canyon Area
Gulf of Mexico

<u>Date</u>	<u>Time</u>		<u>Description of Activities</u>
	<u>From</u>	<u>To</u>	
May 3, 2005 (cont.)	****	0635	Guide funnel section back in moonpool. Mount funnel section back on the seabed frame.
	****	0655	Lower compatts into moonpool and mount them on seabed frame.
	0730	0820	Make up bottom hole assembly.
	****	0805	Lower bottom hole assembly into moonpool.
	0820	1000	Run collars.
	****	0850	Drill string touches sea level.
	1000	1817	Run drillpipe to seafloor.
	****	1020	ROV deployed.
	****	1400	Vessel set up on AT14#2 site.
	****	1450	Coordinates provided for location AT14 ATM-1.
	****	1500	Move to AT14 ATM-1 location.
	****	1535	Vessel on location AT14 ATM-1.
	****	1817	Drillstring ~10-ft (3.0m) off bottom.
	1817	1945	ROV places compatts on seafloor.
	****	1840	ROV breaks off dead weight of Compatt #1. Secure Compatt #1 back on seabed frame.
	****	1916	ROV places Compatt #2 on seafloor.
	****	1945	Measure water depth to 4,252-ft (1296.0m) using pipe tally and ROV observation.
	1945	2010	Rig up FHPC 1H.
	2010	2145	Troubleshoot mud pump.
	2145	2400	Deploy FHPC 1H to mudline at ATM-1.
	****	2145	Lower FHPC 1H to depth.
	****	2230	Fire FHPC 1H and commence recovery.
	****	2300	FHPC 1H back on deck. Total recovery = 7.2-ft (2.2m).
May 4, 2005	0000	0045	Boring advanced to ~24-ft (7.3m) BML.
	****	0000	Rig up for FHPC 2H.
	0045	0230	Deploy FHPC 2H to 24-ft (7.3m) BML.
	****	0130	Fire FHPC 2H and commence recovery.

SUMMARY OF FIELD OPERATIONS

Chevron Texaco Gas Hydrates JIP

Blocks 13 and 14, Atwater Valley Area – Block 151, Keathley Canyon Area
Gulf of Mexico

<u>Date</u>	<u>Time</u>		<u>Description of Activities</u>
	<u>From</u>	<u>To</u>	
May 4, 2005 (cont.)	****	0200	Piston rod stuck in topdrive.
	****	0220	Free piston rod.
	****	0230	FHPC 2H back on deck. Total recovery = 29.9-ft (9.1m).
	0230	0520	Standing-by. ROV re-surface for servicing on manipulator and electronics.
	0520	0605	ROV deployed.
	****	0605	ROV on bottom.
	0605	0635	ROV releases bit locks of seabed frame.
	0635	0705	Recommence drilling from 24-ft (7.3m) to 52-ft (15.8m) BML.
	0705	0910	Deploy FPC 3P to 52-ft (15.8m) BML.
	****	0755	Fire FPC 3P and commence recovery.
	****	0850	FPC 3P back on deck.
	0910	0925	Boring advanced to ~57-ft (17.4m) BML.
	0925	1040	Deploy HRC 4H to 57-ft (17.4m) BML.
	****	1000	Fire HRC 4H and commence recovery.
	****	1015	ROV opens sea clamp.
	****	1030	HRC 4R back on deck.
	1040	1050	Boring advanced to ~62-ft (18.9m) BML.
	1050	1210	Deploy FHPC 5H to 62-ft BML.
	****	1105	Lower FHPC 5H to depth.
	****	1130	Pre-Shift Safety Meeting.
	****	1140	Fire FHPC 5H and commence recovery.
	****	1200	FHPC back on deck.
	1210	1215	Boring advanced to ~88-ft (26.8m) BML.
	1215	1430	Deploy FPC 6P to 88-ft (26.8m) BML.
	****	1300	Lower FPC 6P to depth.
	****	1330	Fire FPC 6P and commence recovery.
	****	1410	FPC 6P back on deck.
	1430	1435	Sweep hole with 100 BBL mud.
	1435	1510	Pull drillstring to mudline.
	1510	1542	ROV closes bit locks.

SUMMARY OF FIELD OPERATIONS

Chevron Texaco Gas Hydrates JIP

Blocks 13 and 14, Atwater Valley Area – Block 151, Keathley Canyon Area
Gulf of Mexico

<u>Date</u>	<u>Time</u>		<u>Description of Activities</u>
	<u>From</u>	<u>To</u>	
May 4, 2005 (cont.)	1542	1605	Seabed frame off bottom.
	1605	1625	DP to ATM-4 site.
	1625	1645	Rig up FHPC 1H and seabed frame.
	****	1630	M/V Gilbert McCall alongside. Offloading and personnel transfer. Measure water depth to 4,250-ft using pipe tally and ROV observation.
	1645	1735	Deploy FHPC 1H to mudline.
	****	1715	Fire FHPC 1H and commence recovery.
	****	1735	FHPC 1H back on deck. Total recovery = 12.5-ft (3.8m).
	1735	1830	Boring advanced to 26-ft (7.9m) BML.
	1830	1935	Deploy FHPC 2H to 26-ft (7.9m) BML.
	****	1900	Fire FHPC 2H and commence recovery.
	****	1935	FHPC 2H back on deck. Total recovery = 20.4-ft (6.2m).
	1935	2010	Boring advanced to 52-ft (15.8m) BML.
	2010	2110	Standing-by. Starboard Stern crane broken down.
	2110	2135	Boring advanced to 57-ft (17.4m) BML.
	2135	2230	Deploy FHPC 3H to 57-ft (17.4m) BML.
	****	2200	Fire FHPC 3H and commence recovery.
	****	2230	FHPC 3H back on deck. Total recovery = 29.4-ft (9.0m).
	2230	2320	Boring advanced to 83-ft (25.3m) BML.
	****	2330	Pre-Shift Safety Meeting.
2320	2400	Deploy FHPC 4H to 83-ft (25.3m) BML.	
May 5, 2005	0000	0100	Continue to deploy HRC 4R to 83-ft (25.3m) BML.
	****	0010	Launch HRC 4R, recover tool to deck.
	****	0100	HRC 4R back on deck. No recovery; sleeve jammed with core catcher.
	0100	0115	Stand-by. Troubleshooting mud pump.
	0115	0125	Advance boring to 88-ft (26.8m) BML.
	0125	0300	Deploy FPC 5P to 88-ft (26.8m) BML.

SUMMARY OF FIELD OPERATIONS

Chevron Texaco Gas Hydrates JIP

Blocks 13 and 14, Atwater Valley Area – Block 151, Keathley Canyon Area
Gulf of Mexico

<u>Date</u>	<u>Time</u>		<u>Description of Activities</u>
	<u>From</u>	<u>To</u>	
May 5, 2005 (cont.)	****	0205	Fire FPC 5P, recover tool to deck.
	****	0255	FPC 5P back on deck.
	0300	0315	Advance boring to 95-ft (29.0m) BML.
	0315	0435	Deploy HRC 6H to 95-ft (29.0m) BML.
	****	0400	Fire HRC 6H, recover tool to deck.
	****	0435	HRC 6H back on deck. No recovery; Sleeve jammed with core catcher.
	0435	0500	Pump heavy mud and run sweeps.
	0500	0605	Rig up to commence tripping pipe out of the hole and to deck.
	****	0530	ROV closes both bit locks on seabed frame.
	****	0600	Lift seabed frame ~30-ft (9.1m) off bottom.
	****	0605	ROV recovers compatt from seabed and latches onto seabed frame.
	0605	1430	Pull pipe and seabed frame back to deck.
	****	0730	Helicopter lands on vessel.
	****	0735	Helicopter departs.
	****	1130	Pre-Shift Safety Meeting.
	****	1245	Client Rep informs all parties to abandon location without recovering marker buoy set on April 22, '05.
	****	1400	ROV recovered to deck.
	****	1430	Seabed frame recovered in moonpool, sat down on spider beams.
	1430	1700	Pull up on drill collars and BHA, lift seabed frame to deck and secure for transit.
	****	1545	Start moving towards Keathley Canyon Area, begin de-ballast.
	1700	2400	En-Route to Keathley Canyon Area.
	****	2225	De-ballasting completed.
	****	2330	Pre-Shift Safety Meeting.

SUMMARY OF FIELD OPERATIONS

Chevron Texaco Gas Hydrates JIP

Blocks 13 and 14, Atwater Valley Area – Block 151, Keathley Canyon Area
Gulf of Mexico

<u>Date</u>	<u>Time</u>		<u>Description of Activities</u>	
	<u>From</u>	<u>To</u>		
May 6, 2005	0000	0145	En-route to Keathley Canyon 151.	
	0145	0220	M/V Annabeth McCall alongside for personnel and cargo transfer.	
	****	0220	Three (3) personnel boarding rig; M/V Annabeth McCall standing by for cargo transfer as conditions do not permit alongside operations.	
	0220	0900	En-route to Keathley Canyon 151. M/V Annabeth McCall standing by for cargo transfer.	
	0900	1010	Vessel stopped: M/V Annabeth McCall alongside for cargo transfer.	
	****	1000	Transfer completed. M/V Annabeth McCall departs location.	
	1010	2400	En-route to Keathley Canyon Area, Block 151.	
	****	1130	Pre-Shift Safety Meeting.	
	****	1300	Abandon Ship Drill (all personnel) and fire drill (marine crew only).	
	****	1610	Vessel stopped for personnel transfer: M/V Annabeth McCall back alongside, two (2) personnel departing rig.	
	****	2330	Pre-Shift Safety Meeting.	
	May 7, 2005	0000	0400	En-route to Keathley Canyon Area, Block 151.
		****	0400	On location, Keathley Canyon Area, Block 151.
		0400	0715	Performing DP trials while ballasting down.
0715		1000	Assembling Schlumberger LWD BHA.	
****		0805	Non-essential personnel to abandon drillfloor. Lower bottom radioactive source into BHA.	
****		0930	Non-essential personnel to abandon drillfloor. Lower top radioactive source into BHA.	
1000		1125	Continuing to run drill collars and drilling jar.	
****		1130	Pre-Shift Safety Meeting.	
****		1145	ROV on bottom, meeting basket to position compatts, take water and soil samples.	
1125		1245	Running drill pipe.	
****		1253	ROV triggered both NISCAN Niscan bottles ~ 5-ft above seafloor.	

SUMMARY OF FIELD OPERATIONS

Chevron Texaco Gas Hydrates JIP

Blocks 13 and 14, Atwater Valley Area – Block 151, Keathley Canyon Area
Gulf of Mexico

<u>Date</u>	<u>Time</u>		<u>Description of Activities</u>
	<u>From</u>	<u>To</u>	
May 7, 2005 (cont.)	****	1245	Performed Schlumberger LWD Pump Test: Problems with individual tool communications.
	1245	1630	Recover drill collars and BHA to deck to change out BHA.
	****	1255	ROV conducts seafloor sampling.
	****	1312	Recover basket to deck.
	****	1445	Non-essential personnel to abandon drillfloor. Recover top radioactive source from BHA.
	****	1545	Non-essential personnel to abandon drillfloor. Recover bottom radioactive source from BHA.
	****	1630	Recovered drill string, BHA and bit to deck.
	1630	1640	Swap out BHA, rig up to deploy new BHA.
	1640	1915	Assemble LWD BHA, lower drill collars below deck.
	****	1705	Non-essential personnel to abandon drillfloor. Lower bottom radioactive source into BHA.
	****	1830	Non-essential personnel to abandon drillfloor. Lower top radioactive source into BHA.
	****	1915	Performed Schlumberger LWD Pump Test successfully.
	1915	2400	Lower drill string below deck.
	****	2330	Pre-Shift Safety Meeting.
	May 8, 2005	0000	0435
****		0300	M/V Gloria B Callais alongside for fuel transfer.
****		0330	Bunkering fuel.
0435		0520	All stop on drill floor: Troubleshoot hydraulic leak on topdrive.
0520		0625	Continuing to run pipe.
0625		0635	Positioning Vessel on location KC151#2.
****		0635	Measure water depth of 4,337-ft using pipe tally and ROV observation.
0635		2400	Spud in, drill and conduct MWL/LWD from mudline to 732-ft (223.1m) BML.
****		0645	Survey taking fix on boring location using beacon mounted on ROV.

SUMMARY OF FIELD OPERATIONS

Chevron Texaco Gas Hydrates JIP

Blocks 13 and 14, Atwater Valley Area – Block 151, Keathley Canyon Area
Gulf of Mexico

<u>Date</u>	<u>Time</u>		<u>Description of Activities</u>
	<u>From</u>	<u>To</u>	
May 8, 2005 (cont)	****	0730	Completed fuel bunkering; transferring cargo from M/V Gloria B Callais to rig.
	****	0950	Backloading on M/V Gloria B Calais complete. Vessel departing location.
	****	1005	Boring advanced to ~137-ft (71.8m) BML.
	****	1130	Pre-Shift Safety Meeting.
	****	2330	Pre-Shift Safety Meeting.
	****	2400	Boring advanced to ~732-ft (223.1m) BML.
May 9, 2005	0000	2045	Continue drilling and logging from 732-ft (223.1m) to TD at 1,507-ft (459.3m) BML.
	****	0645	M/V Genesis alongside rig. Taking on 20 pallets of salt gel.
	****	1130	Pre-Shift Safety Meeting.
	2045	2130	Pumping 85 BBL drilling mud downhole before pulling pipe to deck.
	2130	2400	Pulling pipe to deck.
	****	2330	Pre-Shift Safety Meeting.
	****	2400	Drill bit at ~1,380-ft (420.6m) BML.
May 10, 2005	0000	0220	Continue pulling pipe to 199-ft (60.7m) BML.
	****	0220	ROV and driller observe fluid and gas expulsion in vicinity of drill string.
	0220	0915	All stop. Potential presence of shallow gas or water flow source.
	****	0226	Stab safety valve on drill string.
	****	0245	Pump mud downhole to contain rising gas/shallow flow.
	****	0426	Remove safety valve.
	****	0500	Run bit down to 354-ft (107.9m) BML and pump mud downhole.
	****	0550	ROV observes a ~10-ft diameter crater around well. Flow appears to be contained.
	****	0600	Pull up on bit to 323-ft (98.5m) BML. Flow once again active.

SUMMARY OF FIELD OPERATIONS

Chevron Texaco Gas Hydrates JIP

Blocks 13 and 14, Atwater Valley Area – Block 151, Keathley Canyon Area
Gulf of Mexico

<u>Date</u>	<u>Time</u>		<u>Description of Activities</u>
	<u>From</u>	<u>To</u>	
May 10, 2005 (cont.)	****	0605	Lower bit to 354-ft (107.9m) BML, standing-by and monitoring flow.
	****	0715	ROV observes increasing flow.
	****	0730	Pump mud downhole to contain flow.
	****	0800	Pull bit up to 323-ft (98.5m) BML.
	****	0810	Drilling down to clean out hole.
	****	0900	Bit at 416-ft (126.8m) BML.
	****	0915	Lower basket with marker buoy.
	0915	1925	Recover drill pipe to deck.
	****	1015	ROV positions marker buoy near well location. Proceed to pick up compatt.
	****	1055	ROV secures compatt on basket. Recover basket to deck.
	****	1100	Bit at 4,132-ft (1,259.4m) water depth.
	****	1130	Pre-Shift Safety Meeting.
	****	1145	Basket recovered with one (1) compatt to deck.
	****	1420	Helicopter lands on rig; (2) personnel boarding vessel.
	****	1428	Helicopter departs.
	****	1430	Deploy basket with (4) NISCAN bottles to depth.
	****	1508	ROV leaves TMS to rendezvous with basket.
	****	1511	ROV guiding basket to bottom.
	****	1620	Trigger NISCAN 1/4.
	****	1721	Trigger NISCAN 4/4. Recovering basket to deck.
	****	1800	Basket on deck with (4) NISCAN water samples.
	****	1805	ROV recovered to deck.
	****	1925	All drill pipe and collars on deck.
	1925	2110	Recovering BHA to deck.
	****	1935	Non-essential personnel to abandon drillfloor. Recover top radioactive source from BHA.
	****	2040	Non-essential personnel to abandon drillfloor. Recover bottom radioactive source from BHA.
	****	2110	Drill bit on deck.
	2110	2220	Rig up for running pipe to mudline.

SUMMARY OF FIELD OPERATIONS

Chevron Texaco Gas Hydrates JIP

Blocks 13 and 14, Atwater Valley Area – Block 151, Keathley Canyon Area
Gulf of Mexico

<u>Date</u>	<u>Time</u>		<u>Description of Activities</u>
	<u>From</u>	<u>To</u>	
May 10, 2005 (cont.)	****	2210	Lift seabed frame onto moonpool and move underneath derrick.
	2220	2330	Standing by: Troubleshooting torque sensor.
	2330	2400	Rig up to run pipe to mudline.
	****	2330	Pre-Shift Safety Meeting.
	****	2345	Seabed frame lifted in moonpool and lowered on spider beams.
May 11, 2005	0000	0400	Continuing to rig up for running pipe to mudline. Seabed frame sitting on spider beams.
	****	0000	Backload M/V Genesis.
	****	0015	Closing drill floor.
	****	0200	M/V Genesis departs location.
	****	0245	BHA below deck, continue running drill collars and drill pipe.
	****	0355	Seabed frame bit locks engaged. Lifted seabed frame off spider beams, continue lowering to mudline.
	0400	1400	Lower seabed frame and run drill pipe to mudline.
	****	0515	ROV deployed to depth to monitor descent of seabed frame and bit to mudline.
	****	0802	ROV leaving from seabed frame.
	****	0828	ROV performing survey in immediate vicinity of KC151#2 site. No flow or gas expulsion identified.
	****	0840	ROV performing 2nd survey of immediate vicinity. No flow or gas expulsion identified.
	****	1130	Pre-Shift Safety Meeting.
	****	1330	Bit ~30-ft off bottom. Rigging up on drill floor to spud in mudline.
	****	1400	Measuring water depth of 4,339-ft (1,322.5m) using pipe tally and ROV observation.
	1400	1508	Deploy FHPC 1H to mudline.
	****	1440	Fire FHPC 1H, recover tool to deck.
	****	1445	M/V Genesis arrives on location. Taking on drilling mud (salt gel), backloading vessel.

SUMMARY OF FIELD OPERATIONS

Chevron Texaco Gas Hydrates JIP

Blocks 13 and 14, Atwater Valley Area – Block 151, Keathley Canyon Area
Gulf of Mexico

<u>Date</u>	<u>Time</u>		<u>Description of Activities</u>
	<u>From</u>	<u>To</u>	
May 11, 2005 (cont.)	****	1508	FHPC 1H recovered to deck. Total recovery = 23.4-ft (7.13m).
		1508	Drilling down to 31-ft (9.45m) BML.
		1550	Deploy FHPC 2H to 31-ft (9.45m) BML.
	****	1635	Fire FHPC 2H; recover tool to deck.
	****	1615	Fire FHPC 2H; recover tool to deck.
	****	1635	FHPC 2H recovered to deck. Total recovery = 25.3-ft (7.70m). Backloading M/V Genesis completed. Vessel standing-by.
		1635	Drilling down to 61-ft (18.59m) BML.
		1715	Deploy FHPC 3H with APCT shoe to 61-ft (18.59m) BML.
	****	1735	Tool approximately at mudline. Stand-by for APCT to adjust.
	****	1742	FHPC 3H on bottom. Fire FHPC 3H; standing-by for APCT data acquisition.
	****	1758	Recovering FHPC 3H to deck.
	****	1820	FHPC 3H on deck. Total recovery = 25.8-ft (7.9m).
		1820	Drilling down to 91-ft (27.7m) BML.
		1850	Deploy FHPC 4H to 91-ft (27.7m) BML.
	****	1922	Fire FHPC 4H; recover tool to deck.
	****	1938	FHPC 4H on deck. Total recovery = 25.8-ft (7.9m).
		1938	Drilling down to 122-ft (37.2m) BML.
		2020	Deploy FHPC 5H to 122-ft (37.2m) BML.
	****	2051	Fire FHPC 5H; recover tool to deck.
	****	2115	FHPC 5H on deck. Total recovery = 25.8-ft (7.9m).
	2115	Drilling down to 328-ft (100.0m) BML.	
May 12, 2005		0000	Continue drilling down to 328-ft (100.0m) BML.
		0245	Deploy FC 6C to 328-ft (100.0m) BML.
	****	0323	Trigger FC 6C; recover tool to deck.
	****	0400	FC 6C back on deck. Dismantle tool on topdrive. Total Recovery = 11.4-ft (3.5m)
		0410	Drilling down to 344-ft (104.9m) BML.

SUMMARY OF FIELD OPERATIONS

Chevron Texaco Gas Hydrates JIP

Blocks 13 and 14, Atwater Valley Area – Block 151, Keathley Canyon Area
Gulf of Mexico

<u>Date</u>	<u>Time</u>		<u>Description of Activities</u>
	<u>From</u>	<u>To</u>	
May 12, 2005 (cont.)	0505	0602	Deploy FPC 7P to 344-ft (104.9m) BML.
	****	0550	Pressurize drillstring to fire FPC 7P. Multiple attempts to fire tool unsuccessful.
	****	0602	Attempt to recover FPC 7P to deck unsuccessful.
	0602	1000	FPC tool stuck in BHA. Continuous attempts to recover tool to deck unsuccessful.
	****	0645	Inform client rep of current situation.
	****	0725	Decide to pump pressure into drillstring, in an attempt to shear the inner rod of FPC tool.
	****	0752	Drillstring pressurized to 1,206 psi, but still unable to free FPC tool.
	****	0810	Second attempt to pressurize drillstring to free tool.
	****	0820	Drillstring pressurized to 2,211 psi, but still unable to free FPC tool.
	****	0830	Drilling down ~3-ft to force FPC upward using soil reaction.
	****	0855	Unable to free FPC tool after repetitive drilling down.
	****	0900	Continue to pull and slack sandline, as per Client's instruction.
	****	0926	Helicopter landing for CDI crew change.
	****	0935	Attempt to snap sandline by holding sandline taut and lifting topdrive.
	****	0938	Helicopter off deck.
	****	0955	Unable to part sandline.
	1000	1050	Rig up to cut sandline at drillfloor level.
	****	1040	Sandline cut at drillfloor level. Tie off excess line.
	1050	2300	Commence tripping pipe from 344-ft (104.9m) BML back to deck.
	****	1130	Pre-Shift Safety Meeting.
	****	1230	Helicopter landing for crew change.
	****	1238	Helicopter off deck.
	****	1240	ROV recovered to deck.
	****	1408	Helicopter landing for departing CVX/science personnel.
	****	1416	Helicopter off deck.

SUMMARY OF FIELD OPERATIONS

Chevron Texaco Gas Hydrates JIP

Blocks 13 and 14, Atwater Valley Area – Block 151, Keathley Canyon Area
Gulf of Mexico

<u>Date</u>	<u>Time</u>		<u>Description of Activities</u>	
	<u>From</u>	<u>To</u>		
May 12, 2005 (cont.)	****	2200	Recovering drill collars to deck.	
	****	2300	Drill collar #18 on deck. Hammer/slide exposed on drill floor.	
	2300	2400	Breaking down BHA and recovering hammer/slide and FPC out of drill string.	
	****	2330	Pre-Shift Safety Meeting.	
May 13, 2005	0000	0212	Breaking down BHA and recovering hammer, slide and FPC out of drill string.	
	****	0125	Attempt to remove FPC section above the sliding sleeve, but without success.	
	****	0140	Expose FPC below the seal bore collar and chain down FPC extension to free tool by lifting the topdrive.	
	****	0155	FPC tool section (from inner rod downward) recovered from the BHA.	
	****	0212	Recover FPC tool (sliding sleeve and hammer mechanism) and seal bore collar on pipe chute.	
	0212	0400	Continuing to troubleshoot stuck FPC tool.	
	****	0400	M/V Gilbert McCall alongside with spare BHA.	
	0400	0415	Transfer spare BHA on deck.	
	****	0415	M/V Gilbert McCall departs.	
	0415	0510	Make up BHA and lower to depth.	
	****	0445	Check inner diameter of spare seal bore collar.	
	0510	0640	Run drill collars	
	0640	1030	Run drill pipe to depth.	
	****	1130	Pre-Shift Safety Meeting.	
	****	0715	ROV deployed to depth.	
	1030	1145	Troubleshoot top drive: Bolted on rotary bowl sheared off.	
	1145	1625	Continuing to run drill pipe to mudline.	
	****	1445	Stuck FPC tool freed from seal bore collar	
	****	1625	Drill bit ~ 10-ft above mudline.	
	1625	1635	ROV guiding drill bit into re-entry funnel of seabed frame.	
	May 13, 2005 (cont.)	1635	2400	Drilling down to depth

SUMMARY OF FIELD OPERATIONS

Chevron Texaco Gas Hydrates JIP

Blocks 13 and 14, Atwater Valley Area – Block 151, Keathley Canyon Area
Gulf of Mexico

<u>Date</u>	<u>Time</u>		<u>Description of Activities</u>
	<u>From</u>	<u>To</u>	
May 14, 2005	****	2110	Install center bit in BHA.
	****	2330	Pre-Shift Safety Meeting
	****	2400	Bit at 565-ft (172.2m) below mudline.
	0000	0545	Continuing to drill down from 565-ft (172.2m) to 689-ft (210.0m) BML.
	****	0425	Boring advanced to 689-ft (210.0m) BML. Lower overshot to retrieve center bit.
	****	0525	Recovering center bit to deck.
	0545	0740	Deploying FC 7C to 689-ft (210.0m) BML.
	****	0620	FC on bottom; Launch FC 7C.
	****	0650	Recovering FC 7C to deck.
	****	0720	FC 7C recovered to deck. Total recovery = 2.9-ft (0.9m).
	0740	0830	Drilling down to 704.5-ft (215.0m) BML.
	0830	1015	Deploying FC 8C to 704.5-ft (215.0m) BML.
	****	0900	FC on bottom. Trigger FC 8C.
	****	0920	Recovering FC 8C to deck.
	****	0955	FC 8C recovered to deck. Total recovery = 13.5-ft (4.1m).
	1015	1130	Drilling down to 725-ft (221.0m) BML.
	1130	1330	Deploying HRC 9H to 725-ft (221.0m) BML.
	****	1130	Pre-Shift Safety Meeting.
	****	1215	HRC 9H on bottom. Run mud sweep before proceeding.
	****	1225	Pressurize drill string to trigger HRC 9H.
	****	1240	ROV disengaging sea clamp; Recovering HRC 9H to deck.
	****	1330	HRC 9H recovered to deck. No recovery.
	1330	1445	Drilling down to 732-ft (223.1m) BML.
1445	1633	Deploying FC 10C to 732-ft (223.1m) BML.	
****	1526	Tool near bottom. ROV closing sea clamps.	
****	1534	Launch FC 10C.	
May 14, 2005 (cont.)	****	1552	Shutting down FC 10C test. Recover FC to deck.

SUMMARY OF FIELD OPERATIONS

Chevron Texaco Gas Hydrates JIP

Blocks 13 and 14, Atwater Valley Area – Block 151, Keathley Canyon Area
Gulf of Mexico

<u>Date</u>	<u>Time</u>		<u>Description of Activities</u>
	<u>From</u>	<u>To</u>	
	****	1633	FC 10C recovered to deck.
	1633	1705	Deploying center bit, drilling out to 745-ft (227.1m) BML.
	1705	1800	Recover center bit to deck.
	1800	1955	Deploying FPC 11P to 745-ft (227.1m) BML.
	****	1845	FPC ~ 100-ft off bottom. Running sweep to clean hole. ROV engaging sea clamps.
	****	1858	FPC 11P on bottom. Pressurize drill string to trigger FPC 11P.
	****	1901	Release pressure from drill string.
	****	1903	Coming up with FPC, ROV disengaging sea clamps.
	****	1908	Recovering FPC 11P to deck.
	****	1955	Pressurized FPC 11P recovered to deck. Total recovery under pressure = 0.65m
	1955	2015	Moving FPC 11P from drill floor into ice trough.
	2015	2125	Deploying center bit, drilling out to 755-ft (230.1m) BML. Recover center bit to deck.
	2125	2138	Closing sea clamp while running sweep.
	2138	2157	Assembling FC in drill pipe.
	2157	2308	Deploying FC 12C to 755-ft (230.1m) BML.
	****	2215	On bottom. Pressurizing drill string and start FC.
	****	2230	De-pressurize drill string, ROV opening sea clamp.
	2230	2244	Standing-by for APCT Temperature data acquisition.
	2244	2308	Pulling FC 12C out of formation, recovering tool to deck.
	2308	2315	Recover FC 12C into ice trough. Total recovery = 2.09m.
	****	2330	Pre-Shift Safety Meeting.
	2315	2400	Deploying center bit, drilling out to 774-ft (236.0m) BML. Recover center bit to deck.

SUMMARY OF FIELD OPERATIONS

Chevron Texaco Gas Hydrates JIP

Blocks 13 and 14, Atwater Valley Area – Block 151, Keathley Canyon Area
Gulf of Mexico

<u>Date</u>	<u>Time</u>		<u>Description of Activities</u>
	<u>From</u>	<u>To</u>	
May 15, 2005	0000	0215	Continue to drill down with center bit to 774-ft (236.0m) BML.
	****	0115	Lower overshot to recover center bit.
	****	0215	Center bit back on deck.
	0215	0430	Deploy HRC 13R to 774-ft (236.0m) BML.
	****	0305	HRC 13R on bottom. Fire HRC 13R.
	****	0325	Recover HRC 13R to deck.
	****	0415	HRC 13R back on deck.
	****	0430	HRC 13R on racks. Recovery of pressure core =
	0430	0725	Drill down with center bit to 794-ft (242.0m) BML.
	****	0625	Lower overshot to recover center bit.
	****	0725	Center bit back on deck.
	0725	0915	Deploy FC 14C to 794-ft (242.0m) BML.
	****	0810	FC 14C on bottom. Trigger FC 14C.
	****	0815	Unable to build-up pressure in drillstring. Re-trigger FC 14C.
	****	0835	Recover FC 14C to deck.
	****	0905	FC 14C back on deck. Total recovery = 10.8-ft (3.3m).
	****	0915	FC 14C in processing container.
	0915	1135	Drill down with center bit to 827-ft (251.5m) BML.
	****	1130	Pre-Shift Safety Meeting.
	1135	1325	Deploy FC 15C to 825-ft (252.1m) BML.
	****	1215	FC 15C on bottom. Trigger FC 15C.
	****	1235	Informed by Client Rep on the revision of sampling schedule. Recover FC 15C back on deck.
	****	1315	FC 15C back on deck. Total recovery = 11.5-ft (3.5m).
	****	1325	FC 15C in processing container.
	1325	1415	Drill down without center bit to 840-ft (256.0m) BML.
	1415	1525	Change hydraulic oil in topdrive.
	1525	1555	Pump sweep in hole.
	1555	1705	Deploy FC 16C to 840-ft (256.0m) BML.

SUMMARY OF FIELD OPERATIONS

Chevron Texaco Gas Hydrates JIP

Blocks 13 and 14, Atwater Valley Area – Block 151, Keathley Canyon Area
Gulf of Mexico

<u>Date</u>	<u>Time</u>		<u>Description of Activities</u>
	<u>From</u>	<u>To</u>	
May 15, 2005 (cont.)	****	1615	FC 16C on bottom. Trigger FC 16C. No indication of hammering.
	****	1625	Re-trigger FC 16C.
	****	1635	FC 16C back on deck. No recovery.
	1705	1740	Rig up FHPC tool.
	1740	1900	Deploy FHPC 17H to 840-ft (256.0m) BML.
	****	1820	FHPC 17H on bottom. Fire FHPC 17H and commence recovery.
	****	1840	FHPC 17H back on deck. Total recovery = 18.5-ft (5.65m).
	****	1900	Move FHPC 17 on ice trough.
	1900	2045	Drill down with center bit to 870-ft (265.2m) BML.
	****	2025	Lower overshot to recover center bit.
	****	2045	Center bit back on deck.
	2045	2250	Deploy FPC 18P to 870-ft (265.2m) BML.
	****	2105	Lower FPC 18P to depth.
	****	2150	FPC 18P on depth. Fire FPC 18P and commence recovery.
	****	2235	FPC 18P back on deck.
	****	2250	Move FPC 18P on ice through.
	2250	2400	Standing-by on drillfloor. Troubleshoot BOP.
	****	2255	No recovery in FPC 18P as liner imploded ~2.5-ft (75cm) above core catcher.
	****	2330	Pre-Shift Safety Meeting.
	May 16, 2005	0000	0215
0215		0515	Deploying center bit and drilling down to 901-ft (274.6m) BML.
****		0415	Lowering overshot to retrieve center bit.
****		0515	Recovered center bit to deck.
0515		0645	Deploying FHPC 19H to 901-ft (274.6m) BML.
****		0610	Fire FHPC 19H; recover FHPC to deck.
****		0640	FHPC 19H recovered to deck. Total Recovery = 7.9m
****		0645	Moving FHPC 19H into ice trough.

SUMMARY OF FIELD OPERATIONS

Chevron Texaco Gas Hydrates JIP

Blocks 13 and 14, Atwater Valley Area – Block 151, Keathley Canyon Area
Gulf of Mexico

<u>Date</u>	<u>Time</u>		<u>Description of Activities</u>
	<u>From</u>	<u>To</u>	
May 16, 2005 (cont.)	0645	1025	Deploying center bit and drilling down to 961-ft (292.9m) BML.
	****	0925	Helicopter landing: MMS inspectors board vessel.
	****	0930	Lowering overshot to retrieve center bit.
	****	1025	Recovered center bit back to deck.
	1025	1220	Deploy FHPC 20H to 961-ft (292.9m) BML.
	****	1130	Pre-Shift Safety Meeting.
	****	1115	FHPC 20H on bottom. Fire FHPC 20H. Standing-by for APCT data acquisition.
	****	1135	Recovering FHPC 20H to deck.
	****	1200	FHPC 20H recovered to deck. Total Recovery = 7.80m
	1220	1350	Deploying center bit and drilling down to 1022-ft (311.5m) BML.
	****	1300	MMS helicopter departing from vessel.
	****	1315	Helicopter landing: (3) Schlumberger personnel boarding vessel.
	****	1320	Helicopter departing vessel.
	****	1322	MMS helicopter landing on vessel.
	1350	1430	Recovering center bit to deck.
	1430	1600	Deploying FHPC 21H to 1022-ft (311.5m) BML.
	****	1425	M/V Genesis alongside for cargo transfer and back loading.
	****	1525	FHPC 21H on bottom. Fire FHPC 21H.
	****	1540	Recovering FHPC 21H to deck.
	****	1600	FHPC 21H recovered to deck. Total Recovery = 2.3m
	1600	1620	Transfer FHPC core to ice trough and processing container.
	1620	1900	Deploying center bit and drilling down to 1084-ft (330.4m) BML.
	****	1900	Recovered center bit to deck.
	1900	1930	Pumping sweep and assembling FC toll for deployment.
	1930	2042	Deploying FC 22C to 1084-ft BML.

SUMMARY OF FIELD OPERATIONS

Chevron Texaco Gas Hydrates JIP

Blocks 13 and 14, Atwater Valley Area – Block 151, Keathley Canyon Area
Gulf of Mexico

<u>Date</u>	<u>Time</u>		<u>Description of Activities</u>
	<u>From</u>	<u>To</u>	
May 16, 2005 (cont.)	****	1956	ROV engaging sea clamps. Pressurizing drill string and launch FC 22C.
	****	2016	De-pressurize drill string, recovering FC 22C to deck.
	****	2042	FC 22C recovered to deck. Total Recovery = 3.0m
	2042	2100	Transfer FC core to ice trough and processing container.
	2100	2300	Deploying center bit and drilling down to 1148-ft (349.9m) BML.
	2300	2345	Recovering center bit to deck.
	****	2330	Pre-Shift Safety Meeting.
	2345	2400	Deploying FC 22C to 1148-ft (349.9m) BML.
May 17, 2005	0000	0145	Continuing to deploy FC 23C to 1148-ft (349.9m) BML.
	****	0030	ROV engaging sea clamps. Pressurizing drill string and launch FC 23C.
	****	0045	Standing-by for APCT data acquisition.
	****	0105	Pulling up on FC 23C, re-lowering FC 23C on bottom and pressurize drill string again.
	****	0110	De-pressurizing drill string, ROV opening sea clamps, recovering FC 23C to deck.
	****	0140	FC 23C back on deck. Total recovery = 1.3-ft (0.4m).
	0145	0230	Standing-by: Troubleshooting mud pump.
	0230	0645	Deploying center bit and drilling down to 1,212-ft (369.4m) BML.
	****	0645	Recovered center bit to deck.
	0645	0825	Deploying FC 24C to 1,212-ft (369.4m) BML.
	****	0700	Lowering FC 24C to depth.
	****	0725	ROV engaging sea clamps. Pressurizing drill string and launch FC 24C.
	****	0745	De-pressurizing drill string, ROV opening sea clamps, recovering FC 24C to deck.
	****	0820	FC 24C recovered to deck. Total recovery = 7.2-ft (2.2m).
	0825	1025	Deploying center bit and drilling down to 1,242-ft (378.6m) BML.

SUMMARY OF FIELD OPERATIONS

Chevron Texaco Gas Hydrates JIP

Blocks 13 and 14, Atwater Valley Area – Block 151, Keathley Canyon Area
Gulf of Mexico

<u>Date</u>	<u>Time</u>		<u>Description of Activities</u>
	<u>From</u>	<u>To</u>	
May 17, 2005 (cont.)	****	1025	Recovered center bit to deck.
	1025	1155	Deploying FC 25C to 1,242-ft (378.6m) BML.
	****	1120	ROV engaging sea clamps. Pressurizing drill string and launch FC 25C.
	****	1130	De-pressurizing drill string, ROV opening sea clamps, recovering FC 25C to deck. Pre-Shift Safety Meeting.
	****	1155	FC 25C recovered to deck. Total recovery = 3.3-ft (1.0m).
	1155	1210	Transferring 25C to processing container.
	1210	1340	Deploying center bit and drilling down to 1,257-ft (383.1m) BML.
	****	1243	Helicopter landing: (6) personnel on.
	****	1246	Helicopter off deck: (1) personnel off.
	****	1320	Recovered center bit to deck. Pumping sweep.
	1340	1530	Deploying HRC 26R to 1,257-ft (383.1m) BML.
	****	1415	ROV engaging sea clamps. Pressurizing drill string and launch HRC 26R.
	****	1440	Shutting down pumps.
	****	1500	De-pressurizing drill string, ROV opening sea clamps, recovering HRC 26R to deck.
	****	1530	HRC 26R recovered to deck.
	1530	1650	Deploying center bit and drilling down to 1,263-ft (385.0m) BML.
	****	1650	Recovered center bit to deck.
	1650	1845	Deploying FPC 27P to 1,263-ft (385.0m) BML.
	****	1742	ROV engaging sea clamps. Pressurizing drill string and launch FPC 27P.
	****	1753	De-pressurizing drill string, ROV opening sea clamps, recovering FPC 27P to deck.
	****	1845	FPC 27P recovered to deck, transferred into ice trough.
	1845	2010	Deploying center bit and drilling down to 1,270-ft (387.1m) BML.
	2010	2050	Running sweep downhole.
	2050	2240	Deploying FC 28C to 1,270-ft (387.1m) BML.

SUMMARY OF FIELD OPERATIONS

Chevron Texaco Gas Hydrates JIP

Blocks 13 and 14, Atwater Valley Area – Block 151, Keathley Canyon Area
Gulf of Mexico

<u>Date</u>	<u>Time</u>		<u>Description of Activities</u>
	<u>From</u>	<u>To</u>	
May 17, 2005 (cont.)	****	2135	ROV engaging sea clamps. Pressurizing drill string and launch FC 28C.
	****	2150	De-pressurizing drill string, ROV opening sea clamps, recovering FC 28C to deck.
	****	2230	FC 28C recovered to deck. No Recovery.
	2240	2330	Deploying center bit and drilling down to 1278-ft (389.5m) BML.
	2330	2400	Running sweeps while assembling HRC on drill floor.
	****	2330	Pre-Shift Safety Meeting.
May 18, 2005	0000	0015	Continue to run sweep.
	0015	0140	Deploy HRC 29R to 1278-ft (389.5m) BML.
	****	0050	Driller indicate that hole has collapsed about 7-ft, with ~15,000 lbs overpull on the bit.
	****	0055	Recover HRC tool to re-run sweep.
	****	0140	HRC 29R back on deck.
	0140	0245	Run sweep to clean hole.
	0245	0425	Re-deploy HRC 29R to 1278-ft (389.5m) BML.
	****	0315	HRC 29R on bottom.
	****	0335	Fire HRC 29R and commence recovery.
	****	0415	HRC 29R back on deck.
	****	0425	HRC 29R on racks. No recovery.
	0425	0520	Drill down to 1280-ft (390.1m) BML without center bit.
	0520	0615	Rig up PIEZO 30PI on topdrive.
	0615	0710	Deploy PIEZO 30PI to depth.
	****	0620	Driller indicate that hole has collapsed again. Dismantle piezoprobe tool to run sweep.
	****	0625	PIEZO 30PI test abandoned.
	****	0710	Piezoprobe tool out of drillstring.
	0710	1515	Drill down with center bit to 1440-ft (438.9m) BML.
	****	1040	M/V Genesis alongside.
	****	1130	Boring advanced to 1367-ft (416.7m) BML.
****	1315	M/V Genesis departs with (2) personnel.	

SUMMARY OF FIELD OPERATIONS

Chevron Texaco Gas Hydrates JIP

Blocks 13 and 14, Atwater Valley Area – Block 151, Keathley Canyon Area
Gulf of Mexico

<u>Date</u>	<u>Time</u>		<u>Description of Activities</u>
	<u>From</u>	<u>To</u>	
May 18, 2005 (cont.)	****	1515	Boring advanced to 1440-ft (438.9m) BML.
	1515	1530	Pull up joints and run sweeps.
	1530	1600	Standing-by on drillfloor. Troubleshoot broken torque pin.
	1600	1835	Continue pulling up joints and running sweeps.
	****	1700	Shallow flow in boring. Pump kill mud downhole.
	1835	1935	Standing-by to mix another batch of kill mud and mounting crown sheave for wireline logging.
	1935	2400	Continue pulling up joints and running sweeps.
	****	1935	High overpull indicating the hole squeezing close around drill pipe.
	****	2100	Bit pulled up to 1251-ft (381.3m) BML. Pull stuck pipe with 45,000 lbs overpull.
	May 19, 2005	0000	0230
****		0120	Bit at 406-ft BML.
****		0125	Lower overshot to recover center bit.
****		0230	Center bit back on deck.
0230		0245	Check sheaves, pins and shackles on derrick crown.
0245		0325	Assemble Schlumberger wireline logging tool on drillfloor.
0325		0400	Lower wireline tool to depth.
****		0400	Wireline tool on bit.
0400		0630	Commence wireline logging.
****		0630	Wireline logging to 1115-ft (340m) BML.
0630		0740	Retrieve wireline tool to deck.
****		0740	Wireline tool back on deck.
0740		0830	Dismantle wireline tool on drillfloor.
0830		0905	Make up VSP tool on drillfloor.
0905		0945	Lower VSP tool to bit.
****		0935	Lower VSP air gun for test firing.
0945		1000	Perform VSP tool trials.
1000		1355	Commence VSP logging.

SUMMARY OF FIELD OPERATIONS

Chevron Texaco Gas Hydrates JIP

Blocks 13 and 14, Atwater Valley Area – Block 151, Keathley Canyon Area
Gulf of Mexico

<u>Date</u>	<u>Time</u>		<u>Description of Activities</u>
	<u>From</u>	<u>To</u>	
May 19, 2005 (cont.)	****	1355	Complete VSP logging at KC151#3 location.
	1355	1415	Recover air gun to deck.
	1415	1445	Rig up for cementing KC151#3 well.
	1445	1515	Recover VSP tool to deck.
	1515	1650	Recover pipe to deck to 250-ft (76.2m) BML.
	1650	1905	Set-up drillfloor and mix batch of cement. Cement well at 250-ft (76.2m) BML.
	1905	2000	Pulling pipe above mudline.
	2000	2100	Rinsing drillpipe and clean out tanks.
	2100	2320	Recover pipe to deck.
	2320	2400	Standing-by on drillfloor. Retrieve broken pin. Bit at 3490-ft (1063.8m) water depth.
	0000	2400	ROV in the water.
May 20, 2005	0000	00015	Continue standing-by on drillfloor.
	****	0000	M/V Seth McCall alongside.
	0015	0030	Continue pulling pipe to deck.
	0030	0300	Back-loading M/V Seth McCall.
	0300	0950	Continue pulling pipe to deck.
	****	0850	Continue pulling drill collars to deck.
	****	0916	ROV on deck.
	****	0950	Seabed frame lifted in moonpool.
	0950	1015	Compatts recovered off seabed frame.
	1015	1030	Continue pulling drill collars and BHA to deck.
	1030	1325	Vessel in transit on DP while ballasted down. Continue to recover BHA to deck and secure for transit.
	****	1130	Pre-Shift Safety Meeting.
	****	1330	BHA recovered to deck, seabed frame lifted on drill floor.
	1325	1405	Vessel stops: M/V Genesis alongside for back loading of equipment.

SUMMARY OF FIELD OPERATIONS

Chevron Texaco Gas Hydrates JIP

Blocks 13 and 14, Atwater Valley Area – Block 151, Keathley Canyon Area
Gulf of Mexico

<u>Date</u>	<u>Time</u>		<u>Description of Activities</u>
	<u>From</u>	<u>To</u>	
May 20, 2005 (cont.)	1405	1700	Transfer vessel control to bridge, ballasting up.
	1700	2400	En-route to Port of Galveston, Tx.
	****	2330	Pre-Shift Safety Meeting.
May 21, 2005	0000	2400	En-route to Port of Galveston, Tx.
	****	1130	Pre-Shift Safety Meeting.
	****	2330	Pre-Shift Safety Meeting.
May 22, 2005	0000	0650	Standing by near Galveston sea buoy.
	****	0645	Helicopter landing: Pilot boards vessel.
	0650	0915	En-route to Pier 10, Port of Galveston, Tx.
	****	0915	Vessel secured alongside Pier 10, Port of Galveston, Tx.

**** **END OF SFO** ****

SUMMARY OF FIELD OPERATIONS

Chevron Texaco Gas Hydrates JIP

Blocks 13 and 14, Atwater Valley Area – Block 151, Keathley Canyon Area
Gulf of Mexico

Fugro Hydraulic Piston Corer Tool Comparison

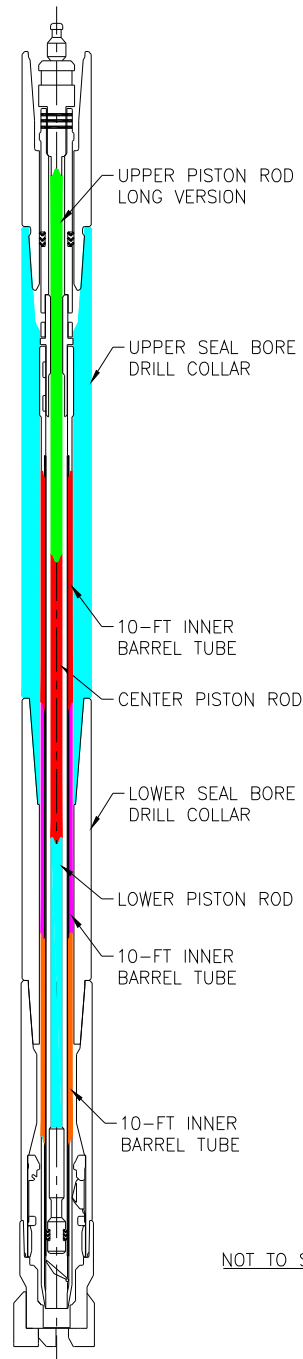

30-FIT STROKE TOOL

NOT TO SCALE

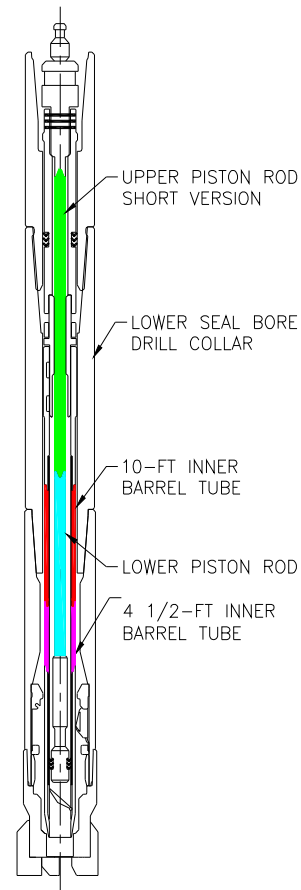

15-FIT STROKE TOOL

Fugro Hydraulic Piston Corer (FHPC)

CVX Gulf of Mexico Gas Hydrates JIP

Fugro Hydraulic Piston Corer

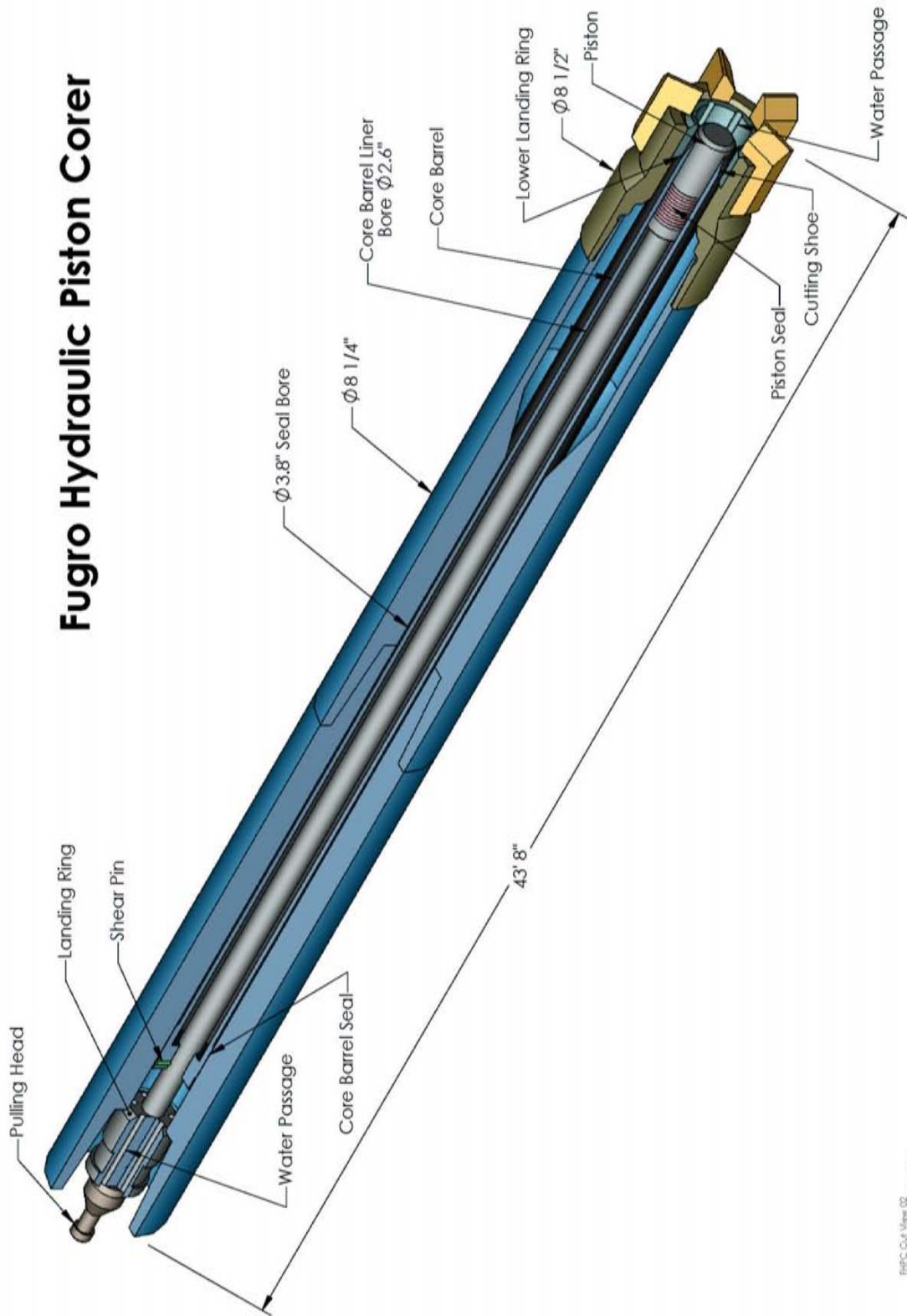

FHPC Cut View 02
Tuesday, June 15, 2004 22:17

Fugro Hydraulic Piston Corer (FHPC)

CVX Gulf of Mexico Gas Hydrates JIP

Fugro CORER™

INTRODUCTION

The Fugro CORER™ is a lightweight downhole hydraulic percussion sampling tool for obtaining high quality cores in a range of ground conditions, including:

- very soft to hard clays and loose to very dense soils;
- cemented sands; and
- weak rock.

The Fugro CORER™ was specifically developed in response to the demand for a tool capable of obtaining high quality samples of very dense, hard and cemented soils and weak rocks. These sediments have traditionally been difficult to sample as they are generally too hard/dense for push sampling but too weak or too friable for rotary coring.

The Fugro CORER™ may also be used for sampling soft soils. For this purpose a version of the Fugro CORER™ is available with a fixed piston.

Development of the Fugro CORER™ commenced in 1997. The tool was successfully used during its first commercial application in the Nankai Trough, offshore Japan in a water depth of 1,000m. The Fugro CORER™ has since been used for numerous projects, including geotechnical investigations from mobile offshore drilling units, fixed platforms and dedicated geotechnical drilling vessels.

The Fugro CORER™ operates without an umbilical. Samples are recovered from beneath the bottom of a borehole with a core tube extending through the drill bit. The activation and penetration of the Fugro CORER™ is achieved by means of drilling fluid pressure within the drill string.

The Fugro CORER™ may be used from land drilling rigs, offshore exploration drilling units and geotechnical or



The Drag Bit is the most commonly used drill bit for marine soil investigations.

scientific drilling vessels. A variety of Fugro CORERs™ is available for different drill string diameters and for use with core tubes of different outer diameters and lengths.

This equipment is patented.

APPLICATION

Geotechnical

Samples obtained using the Fugro CORER™ are suitable for evaluating geotechnical data required for offshore, nearshore and onshore applications including:

- spud-can penetration evaluation and punch-through risk assessment for jack-up exploration drilling rigs;
- foundation analyses for fixed platforms, subsea structures (wellheads, templates), floating structures (single buoy moorings, tension leg platforms, SPARS, FPSOs), breakwaters, barriers, bridges and towers;
- conductor installation analyses; and
- evaluation of materials for dredging and reclamation projects.

Geological

Typical applications include:

- Stratigraphic coring; and
- Paleoclimate research.

Scientific Research

A prototype pressurised Fugro CORER™ has been developed during the European hydrate coring research programme.

EQUIPMENT

The Fugro CORER™ consists of:

- The downhole (percussive) coring tool;
- Core tubes with or without cutting shoes and/or core catchers;
- Internal liners for insertion within the core tubes in which the cores may be preserved after recovery;
- A bottom-hole assembly (BHA);
- A running system to retrieve the Fugro CORER™ after the downhole coring operation; and
- A stand to remove the core from the Fugro CORER™.

The tool system as described, is lighter than other sampling systems and therefore the cost of mobilisation is lower, it also has no umbilical or wire line to activate the sampler and is therefore simpler to operate than other systems.

SAMPLING PROCEDURES

After drilling the borehole to the required sampling depth procedures for operation of the tool are generally as follows:

- The Fugro CORER™ is dropped in free-fall down the borehole;
- The Fugro CORER™ lands in the sealing sub with the core tube extending through the open drill bit and resting on the bottom of the borehole;
- Pumping of drill fluid into the borehole is commenced;
- The flow of the drill fluid operates a hammer mechanism in the tool, forcing penetration of the core tube into the soil or rock;
- When full stroke is achieved the percussion action automatically stops and a pressure drop alerts the operator;

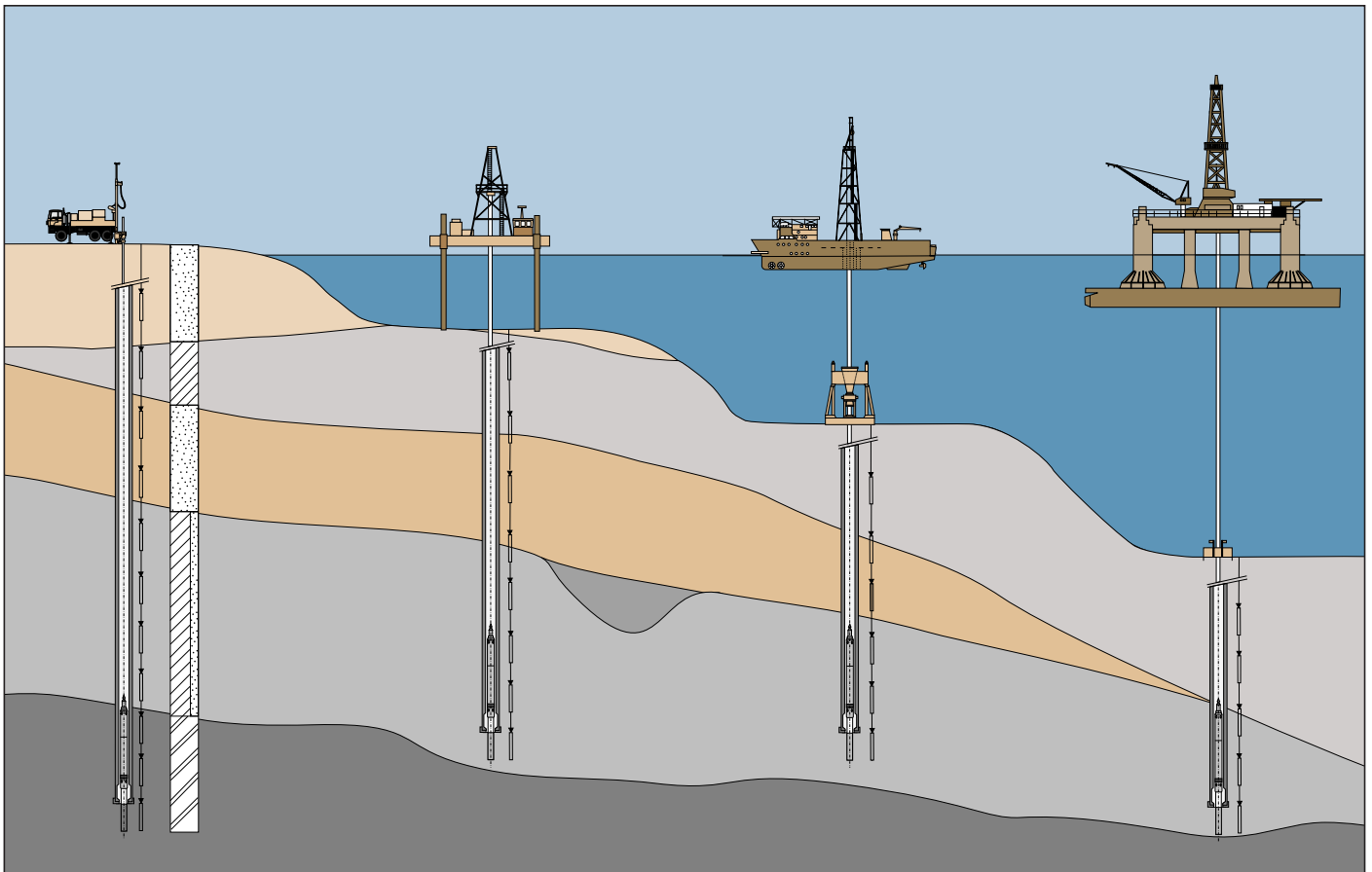

- The drill string is then lifted to extract the core tube from the soil or rock and the string is hung in the slips;
- The running tool is lowered through the drill string and the Fugro CORER™ is retrieved to the surface;
- The core is removed from the Fugro CORER™ and the tool is prepared for its next use.

SELECTION OF CORE TUBES

For samples up to 0.9-m-long, typical for geotechnical investigations, straight-sided steel tubes with an area ratio of 0.1 to 0.2 may be used.

For longer samples, as generally required in stratigraphic and paleoclimate coring programmes, core tubes with liners and cutting shoes are available. Liners and cutting shoes facilitate easier core extrusion and/or the option for longer-term sample preservation. The area ratio of these tubes ranges from 0.4 to 0.6 and core tube lengths of 2.2 and 4.0 metres have been used for the prototype Fugro CORER™- 120.

GENERAL DRILL RIG REQUIREMENTS

- The Fugro CORER™ is retrieved on a wire line using its own running tool. A wire line winch with a capacity in the order of 1,000 to 2,000 kg range suffices.
- Cross-overs are available from the BHA to standard API threads.
- The winch should be capable of free unwinding under a weight of 100 kg.
- During operations the reaction forces of the tool create an upward force on the drill string. Therefore the actual weight of pipe which can be used as reaction during the operations needs to be reviewed with the drilling superintendent.
- Piston coring requires rigid vertical stabilisation of the drill string during tube penetration requiring additional measures like using a template with pipe clamp (SEACLAM).
- An open deck area of about 3 by 8 metres is required for preparing the Fugro CORER™.
- Mud types, such as polymer or bentonite mud or similar to ensure smooth drilling process for open hole geotechnical or geological drilling.

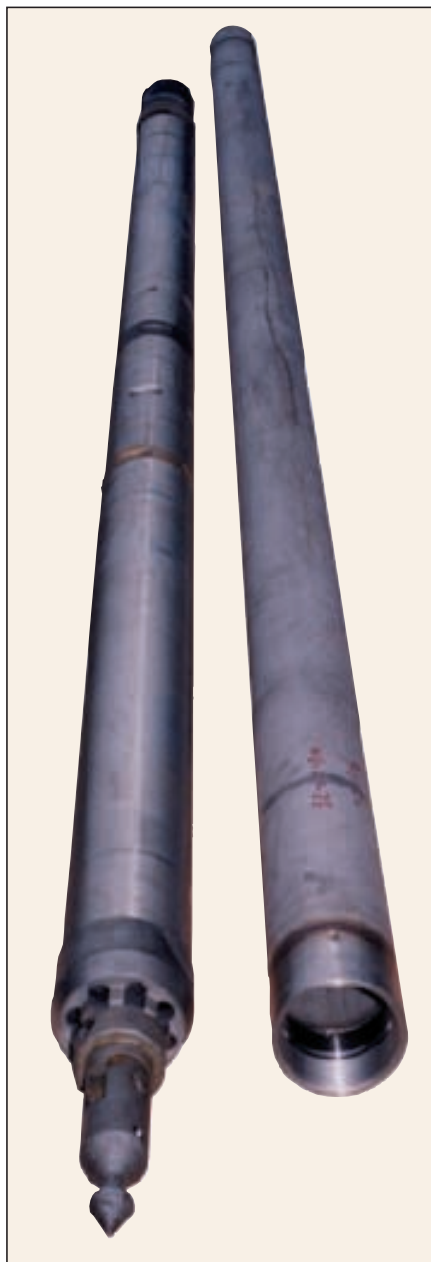

SPECIALS

A prototype Fugro CORER™ -120 is under development. This tool has been dimensioned to be compatible with:

- 6 5/8" drill string;
- 146 mm ID aluminium drill string; and
- other casing systems, such as GEOBOR-S.

As a component of the European HYACE (HYdrate Autoclave Coring Equipment) project an autoclave system is being incorporated into the Fugro CORER™ with the objective of sealing the core tube at ambient pressure and thermal conditions whilst in the borehole. With this feature the Fugro CORER™ can be used for sampling of sediments:

- containing gas or gas hydrates; or
- of interest for studying the deep biosphere.

EQUIPMENT REFERENCE

H.M. Zuidberg, B. Baardman, I. Kobayashi and M. Tsuzuki (1998), " Geotechnical Techniques for Deep Water Coring and Testing Gas Hydrates.", presented at JNOC speciality symposium on methane hydrates, Chiba City, Japan, Oct. 1998.

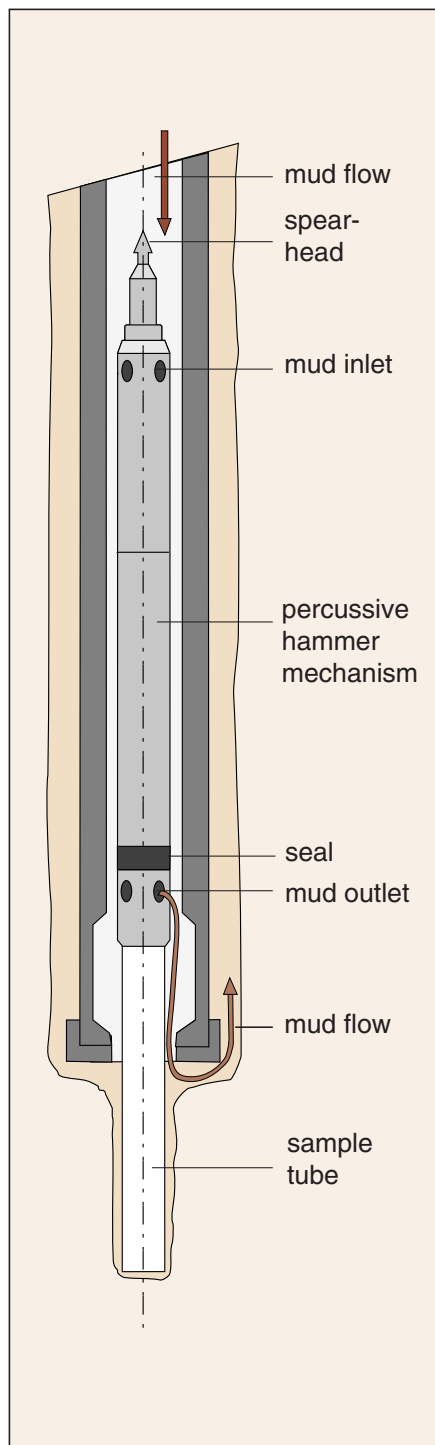

SELECTION OF CORERS™

Two standard CORERS™ are available.

Type	Typical Application	Versions	Comments
Fugro CORER™ -69	<ul style="list-style-type: none"> Geotechnical investigations for exploration drilling rigs (rig moves). 	<ul style="list-style-type: none"> Standard 	Typically deployed in drillstring with 2 7/8" and 3" ID drill collars as used on exploration drill rigs.
Fugro CORER™ -85	<ul style="list-style-type: none"> Geotechnical/ Geological investigation from drilling vessels or from exploration drilling rigs. Scientific purposes. 	<ul style="list-style-type: none"> Standard or piston Pressurised version which retracts the liner into a chamber to maintain sample at ambient pressure, specifically for hydrate sampling. 	Typically deployed in 4 1/2" and 5" drill string as used on dedicated geotechnical drilling vessels. May be used in conjunction with Fugro's WISON/WIP systems. The maximum sample length is approximately 2m.

TOOL SPECIFICATIONS

Dimensions

Type	Tool Outer Diameter (mm)	Sample Diameter (mm)	Sample Length* ¹ (m)	Total Tool Length* (m)	Max Weight (kg)	Shipping Weights (kg)
Fugro CORER™ -69	69	54	0.9	5.4	150	850
Fugro CORER™ -85	85	72	0.9/2.0/4.0	6.0	185	1,500 to 2,000

* Includes running tool and sample tube for 0.9-m sample length

Operating Specifications

Type	Required Minimum Inner Drill String Diameter (mm)	Operating Differential Drill Fluid Pressure (bars)	Flow (litres/minute)	Required reaction (kg)
Fugro CORER™ -69	73 to 105	40 - 50	80 to 100	1,700
Fugro CORER™ -85	94 to 110 (API 4 1/2" or 5")	40 - 50	150 to 200	3,500

The specification of the equipment in this data sheet may be subject to modifications without prior notice.

Fugro Engineers B.V.
 10 Veurse Achterweg.
 P.O. Box 250, 2260 AG Leidschendam. The Netherlands.
 Phone: 31-70-3111444 – Telefax: 31-70-3203640. – E-mail: febvinfo@fugro.nl

Website: www.fugro.com

Fugro Engineers B.V. is a member of the Fugro Group, with offices throughout the world.

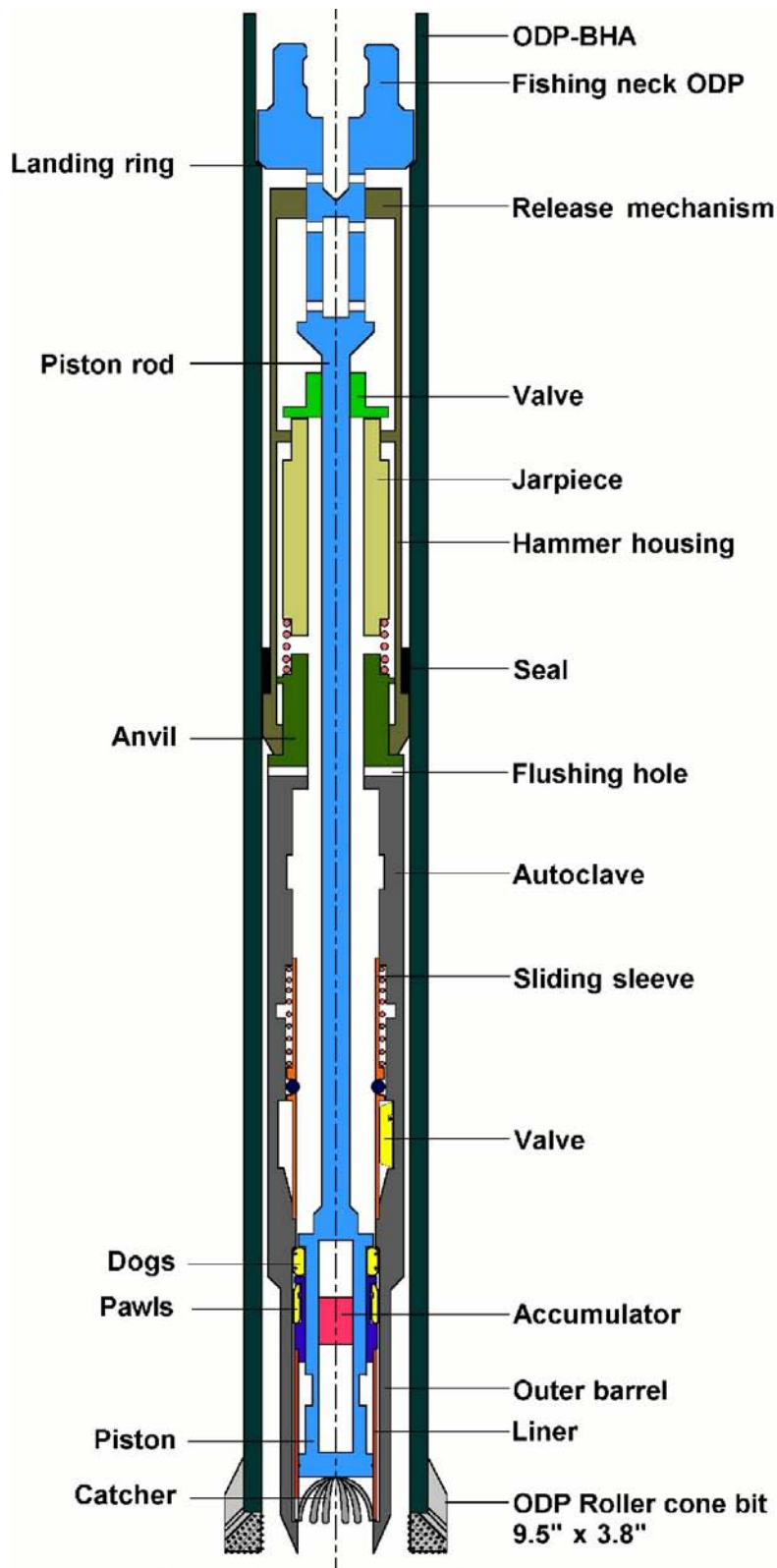

Fugro Pressure Corer (FPC)

CVX Gulf of Mexico Gas Hydrates JIP

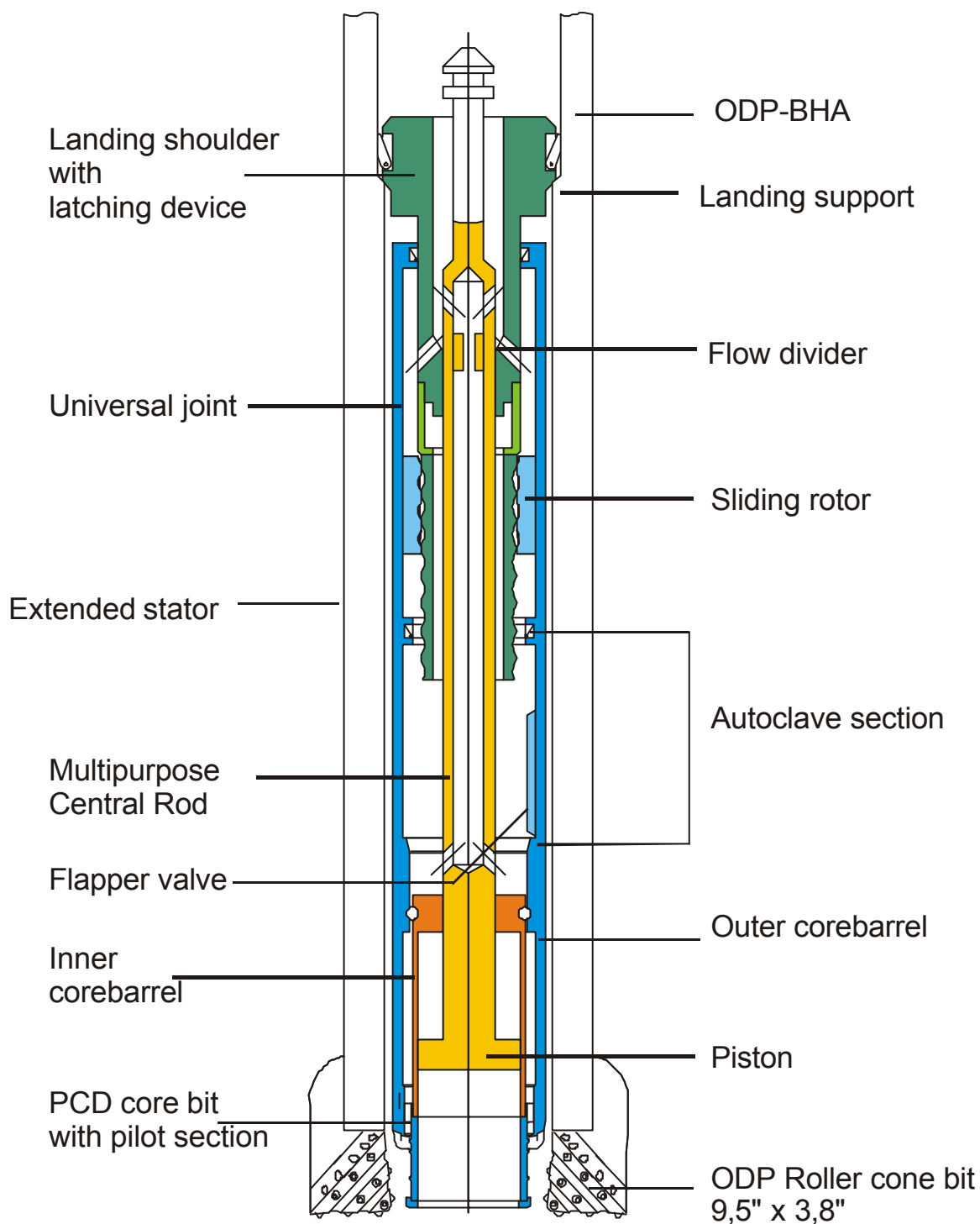

HYACE Rotary Corer (HRC)

CVX Gulf of Mexico Gas Hydrates JIP

Fast, accurate profiles of salinity, temperature, density, sound velocity, dissolved oxygen, pH, ORP, light transmission PAR.

Proven sensors, computer-less field operation, semi-conductor memory, RS-232 data download, powerful software.



Personal
CTD

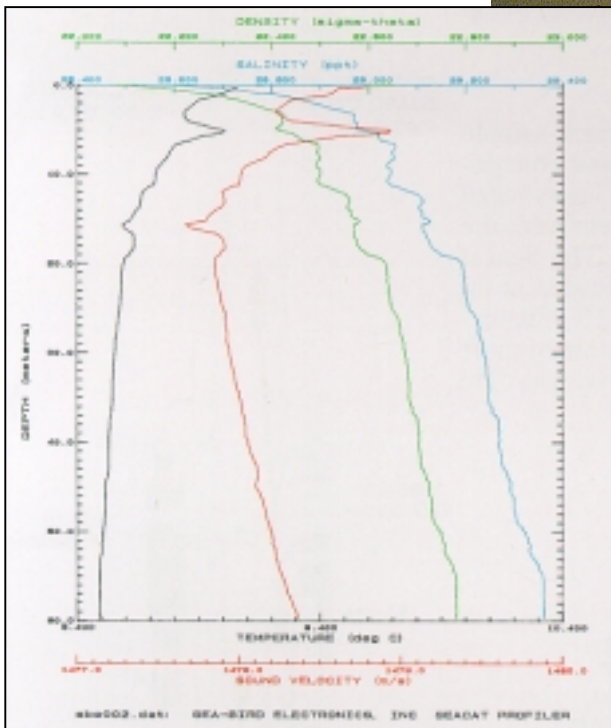

SBE 19 SEACAT Profiler data plotted using Sea-Bird's SEASOFT CTD Data Acquisition software. Salinity, density, and sound velocity were computed from the raw conductivity, temperature, pressure data according to the algorithms in Unesco Technical Paper no. 44 which incorporate the 1978 International Practical Salinity Scale (IPSS 78) and the 1980 equations of state (EOS 80).

Very narrow ranges of each variable have been chosen (for example, 1 ppt in salinity) so that the Profiler's high resolving capability may be easily perceived. SEASOFT offers menu control of variable choices and ranges.

The plot was made using an IBM PC Compatible computer and Hewlett-Packard HP 7475A plotter.

CONVENIENCE - PORTABILITY - PERFORMANCE - VALUE



Sea-Bird Electronics, Inc.
1808 136th Place NE, Bellevue, Washington 98005 USA
Website: <http://www.seabird.com>

Fax: (425) 643-9954
Tel: (425) 643-9866
Email: seabird@seabird.com

OPERATION

The SEACAT Profiler samples at a programmable rate up to 2 "scans" per second, and is able to characterize the water column with high accuracy and half-second resolution. Conductivity and temperature frequencies are multiplexed through a precision Wien bridge. Automatic circuitry periodically corrects any time- or temperature-induced errors in the electronics. Pressure is acquired with high resolution through an A/D converter. Collecting high-quality data is easy and reliable, following these few simple steps:

- Connect the Profiler to a computer, and check instrument status and select sampling parameters using menu-driven SEASOFT software.
- Switch the Profiler ON just before lowering into the water (cast number, time, and date are automatically recorded).
- When the cast is complete, switch the Profiler OFF. Up to 100 casts can be recorded (within limit of available memory) before uploading to computer.
- After recovery, connect Profiler to the computer and transfer the stored CTD data (plus any auxiliary sensor data) to floppy or hard disk files.
- Run SEASOFT's graphing/plotting program to convert to engineering units, display the data, and create presentation quality graphics.

PROFILER CONFIGURATION AND OPTIONS

The SEACAT's sensors consist of an internal-field glass conductivity cell with platinum electrodes, an aged, pressure-protected, thermistor temperature sensor, and a mechanical strain gauge pressure sensor with a stainless steel or titanium element (depending on sensor range). Four single-ended, 12-bit, A/D input channels, and output power for optional auxiliary sensors (+10 volt, 50 ma) are provided through a separate connector. Depending on the auxiliary sensor requirements, the four A/D input channels can be optionally configured as 2 differential input channels and 1 channel can also be configured for a current (log) input sensor (PAR). See Application Note 29 for more information about configuration options.

The standard plastic housing is rated for 600 meters, and holds 9 "D" size alkaline cells. Optional aluminum or titanium housings are available for 3400, 6800, or 10500 meters. Battery life is about 40 hours without optional equipment. Battery life with optional pump and most auxiliary sensors is about 15-20 hours.

MEMORY AND COMMUNICATION

1024K bytes of CMOS static RAM is standard; 2, 4, or 8Mb is optional. Each sample (scan) of conductivity, temperature, and pressure uses 6 bytes. Auxiliary input voltages are stored in pairs, adding 3 bytes per pair. The 1024K memory will last 30 hours when recording C, T, and P at 2 scans per second. When the main batteries are removed, the memory is supported for up to 3 years by board-mounted lithium cells. The SEACAT Profiler communicates via a standard RS-232 interface. Stored data is uploaded at up to 38K baud, permitting 1024K bytes of memory transfer in approximately 10 minutes. In addition to recording internally, real-time data can be simultaneously transmitted short distances at 600 baud. An optional, internal line driver/isolator permits real-time telemetry over cables up to 7,000 meters long.

PROFILER SPECIFICATIONS

	Range	Accuracy	Resolution
Conductivity (S/m)	0 - 7	± 0.001	± 0.0001
Temperature (°C)	-5 to +35	± 0.01	± 0.001
Depth (meters) ¹	60-1000	± 0.25%	± 0.015%
	2000-10000	± 0.15%	± 0.015%
Weight (air)	Plastic housing 6.4 kg; aluminum 9.2 kg; titanium 12.0 kg		
Weight (water)	Plastic housing 2.4 kg; aluminum 5.2 kg; titanium 8.0 kg		

¹Select range for intended operating depth: 60/100/200/340/600/1000/2000/3400/6800 or 10,500 meters. See Application Note 27, *Minimizing Strain Gauge Sensor Errors*

OPTIONAL EQUIPMENT

SBE 5T Submersible Pump	Stainless Steel Guard Cage	Altimeter
NMEA 0183 GPS interface	SBE 18 pH sensor	SBE 27 pH/ORP sensor
SBE 23 Dissolved Oxygen sensor	Transmissometer	Fluorometer
Optical Backscatter Sensor	Chlorophyll Absorption Meter	PAR sensor

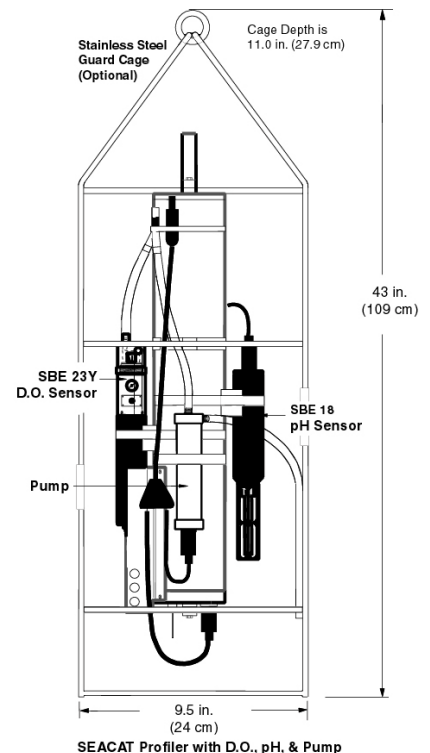
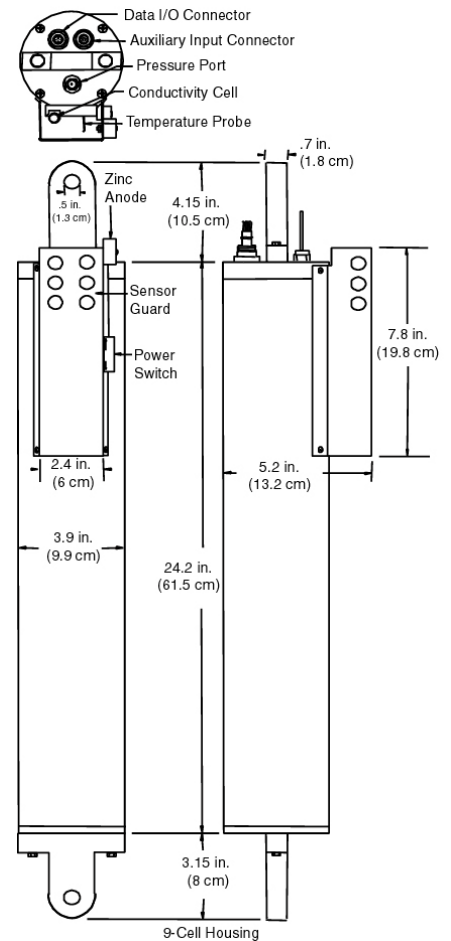

Advanced Piston Corer Temperature

Scientific Application

The Advanced Piston Corer Temperature (APCT) tool is an instrumented version of the coring shoe that is run on the Advanced Piston Corer (APC). It is deployed in soft sediments to obtain formation temperatures to determine the heat flow gradient and is essential in determining hydrocarbon maturity for pollution prevention purposes.

Tool Operation

The APCT is deployed on an APC inner core barrel and provides a precise in situ temperature measurement while adding only 10 min to each core barrel run. Typically, the tool is run starting at 30 m below seafloor (mbsf) and then run after every other core until four good readings are obtained. The shoe is hydraulically stroked 9.5 m into the sediment and remains stationary for ~10 min. The APC inner core barrel is then retrieved, the instrumented shoe is removed, and the data is downloaded into a computer.

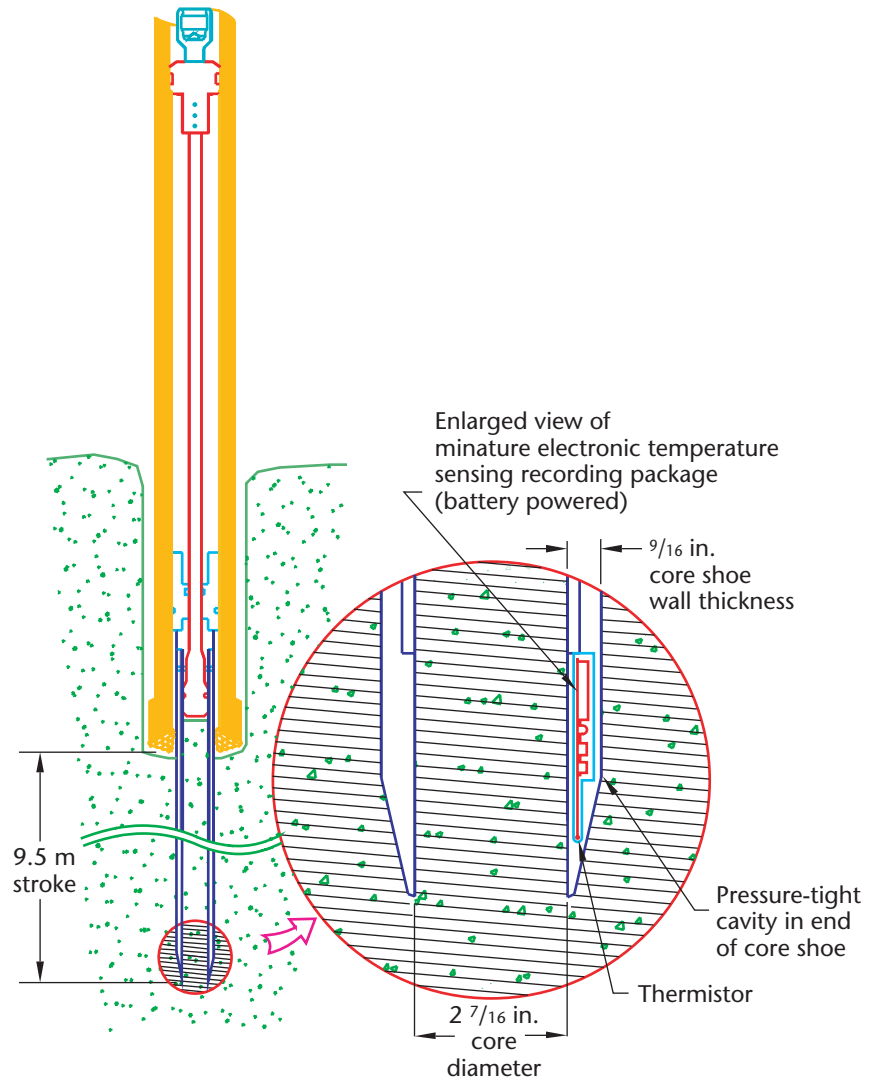

Continuous temperature measurements are recorded with the APCT core shoe embedded in the sediment.

Design Features

1) Temperature Measurement Without Wireline Trip

The APCT sensor, electronics, and memory are contained in an annular cavity inside the APC coring shoe.

Benefit: Temperature measurements can be obtained without a special wireline trip with a temperature tool.

2) Minimal Time Impact

The APCT tool is deployed on an APC inner core barrel and remains stationary for ~10 min in the sediment.

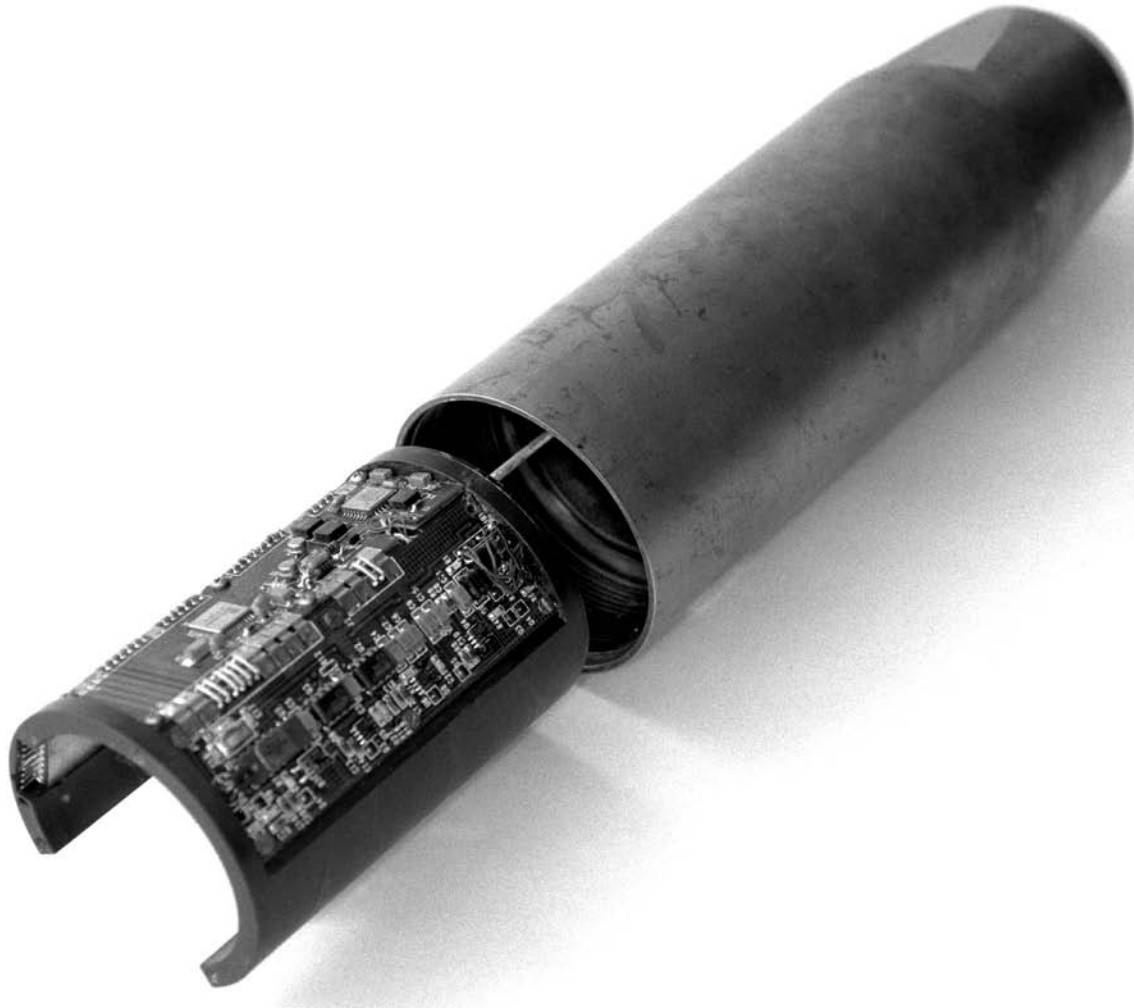

APCT shoe with pocket to accept electronics, memory board, and battery for temperature measurements while taking an APC core.

Benefit: The APCT provides a precise in situ temperature while adding only 10 min to each core barrel run.

3) Rapid Data Download

The instrumented shoe is removed as soon as the APC inner core barrel is retrieved, and the data are downloaded into a computer program for immediate processing.

Benefit: Hydrocarbon maturity evaluations can proceed during coring to avoid delays for data handling.

APCT Specifications

Motorola 68HC811 microprocessor

32K x 8 bit CMOS RAM data storage

Real-time clock

14-bit analog-to-digital converter

Platinum temperature sensor
±0.02°C accuracy

Typical Operating Range

–20°C to +100°C temperature measurement range

Limitations

Can only be used in soft sediments appropriate for piston coring

Can only be used in relatively stable sediments where danger of hole collapse is minimal

APPENDIX B
LABORATORY SOIL TESTING PROGRAM

**LABORATORY SOIL TESTING PROGRAM
CONTENTS**

	<u>Page</u>
LABORATORY SOIL TESTING PROGRAM	B-1
Development of Testing Program	B-1
Classification Tests	B-1
Conventional Strength Tests.....	B-2
Torvane Tests	B-2
Pocket Penetrometer Tests	B-2
Miniature Vane Shear Tests	B-2
Unconsolidated-Undrained Triaxial Compression Tests.....	B-2
One-Dimensional Consolidation Tests.....	B-3
Controlled Rate of Strain (CRS) Consolidation Tests.....	B-3
Static Direct Simple Shear (DSS) Tests	B-3
SHANSEP Procedure for Shear Strength Interpretation	B-4
TruePath™ K ₀ Consolidated-Undrained Triaxial Extension Tests.....	B-5
Hydraulic Conductivity (Permeability) Tests.	B-6

**APPENDIX B
ILLUSTRATIONS**

	<u>Plate</u>
Boring AT13#2,	
Summary of Type and Number of Tests	B-1
Summary of Test Results	B-2
Additional Classification Test Results	B-3
Grain-size Distribution Curves (Hydrometer)	B-4
Summary of 1-D Consolidation Test Results, Boring AT13#2	B-5
1-D Consolidation Tests: Boring AT13#2	
CRS Test at 19.60 m Penetration	B-6
CRS Test at 32.46 m Penetration	B-7
Summary of Static DSS Test Results, Boring AT13#2.....	B-8
Static DSS Tests: Boring AT13#2	
DSS Test at 19.57 m Penetration	B-9
DSS Test at 32.43 m Penetration	B-10
Summary of Static Truepath K_0 Triaxial Test Results: Boring AT13#2 (and KC151#3)	B-11
Static Truepath K_0 Triaxial Extension Tests: Boring AT13#2	
TPK ₀ U'-TE at 23.59 m Penetration	B-12
TPK ₀ U'-TE at 41.30 m Penetration	B-13
Summary of Hydraulic Conductivity (Permeability) Test Series (VHR): Boring AT13#2.....	B-14
Hydraulic Conductivity (Permeability) Test Series (VHR): Boring AT13#2	
Hydraulic Conductivity Test Series at 8.14 m Penetration.....	B-15
Boring KC151#3,	
Summary of Type and Number of Tests	B-16
Summary of Test Results	B-17
Additional Classification Test Results	B-18
Grain-size Distribution Curves (Hydrometer)	B-19
Stress-Strain Curves	B-20
Summary of 1-D Consolidation Test Results, Boring KC151#3.....	B-21
1-D Consolidation Tests: Boring KC151#3	
CRS Test at 42.40 m Penetration	B-22
CRS Test at 44.16 m Penetration	B-23
CRS Test at 100.83 m Penetration	B-24
CRS Test at 210.17 m Penetration	B-25
CRS Test at 224.30 m Penetration	B-26
CRS Test at 230.98 m Penetration	B-27
CRS Test at 243.70 m Penetration	B-28
CRS Test at 278.62 m Penetration	B-29
CRS Test at 313.21 m Penetration	B-30
CRS Test at 370.51 m Penetration	B-31

**APPENDIX B
ILLUSTRATIONS (cont.)**

	<u>Plate</u>
Summary of Static DSS Test Results, Boring KC151#3	B-32
Static DSS Tests: Boring KC151#3	
DSS Test at 42.35 m Penetration	B-33
DSS Test at 100.69 m Penetration	B-34
DSS Test at 210.22m Penetration	B-35
DSS Test at 224.21 m Penetration	B-36
DSS Test at 230.93 m Penetration	B-37
DSS Test at 243.75 m Penetration	B-38
DSS Test at 278.54 m Penetration	B-39
DSS Test at 313.17 m Penetration	B-40
DSS Test at 370.56 m Penetration	B-41
Shear Stress Versus Consolidation Pressure	B-42
Summary of Static Truepath K_0 Triaxial Test Results: Boring KC151#3 (and AT13#2)	B-43
Static Truepath K_0 Triaxial Extension Tests: Boring KC151#3	
TPK ₀ U'-TE at 216.62 m Penetration	B-44
TPK ₀ U'-TE at 258.99 m Penetration	B-45
Summary of Hydraulic Conductivity (Permeability) Test Series (VHR): Boring KC151#3	B-46
Hydraulic Conductivity (Permeability) Test Series (VHR): Boring KC151#3	
Hydraulic Conductivity Test Series at 44.11 m Penetration.....	B-47
Hydraulic Conductivity Test Series at 100.78 m Penetration.....	B-48
Hydraulic Conductivity Test Series at 243.66 m Penetration.....	B-49

LABORATORY SOIL TESTING PROGRAM

Development of Testing Program

The laboratory soil testing program was performed to evaluate pertinent index and engineering properties of the soils encountered in the boring samples. The laboratory soil testing program for this study was performed in three phases:

1. Visual classification, submerged unit weight determinations, natural water content measurements, undisturbed shear strength tests (Torvane, miniature vane shear (MV) and unconsolidated-undrained (UU) triaxial compression tests), and remolded shear strength tests (MV) were performed concurrently with drilling, sampling and in situ testing operations during the field investigation;
2. Conventional laboratory tests, including Atterberg limits tests, natural water content measurements and strength tests on selected samples were performed in our Houston laboratory to supplement the field data; and
3. Additional classification and advanced laboratory tests, including specific gravity tests, hydrometer analyses, controlled rate of strain (CRS) one-dimensional consolidation tests, static, strain-controlled, consolidated-undrained, direct simple shear (CK₀U'-DSS) tests, static TruePath™ K₀ consolidated-undrained triaxial extension (TPK₀U'-TE) tests, with pore-water pressure (PWP) measurements and strain-controlled loading, and hydraulic conductivity (permeability) test (S₂-CI-HC-VHR) series with multiple consolidation stages and with the specimen orientation being representative of vertical, horizontal, or remolded conditions were performed as part of the advance testing program.

Offshore testing was performed on samples recovered from Borings AT13#2 and KC151#3, as well as on selected ROV push cores. Onshore conventional and advanced laboratory tests were performed on samples from Borings AT13#2 and KC151#3, only.

The following paragraphs give detailed descriptions of the conventional and advanced static laboratory tests performed offshore and/or in Fugro's Houston laboratory on samples from Borings AT13#2 and KC151#3. The tests were performed in accordance with ASTM Standards (2004) unless stated otherwise. Summaries of type and number of tests performed for each boring is presented on Plates B-1 and B-16.

Classification Tests

Plastic and liquid limit tests, collectively termed Atterberg limits, and water content was determined for each cohesive sample to provide classification information. Natural water content determinations were made for each UU triaxial compression and miniature vane shear test specimen. Bulk densities of soil samples where possible, were measured in the field by weighing a sample of known volume immediately after extrusion. Results of Atterberg limit tests, natural water content determinations, and the estimated submerged unit weight from the total unit weight measurements from the offshore and standard onshore laboratory programs are tabulated on Plates B-2 and B-17 for Borings AT13#2 and KC151#3, respectively.

Results of the Atterberg limits tests, natural water content determinations, and the estimated submerged unit weight from the total unit weight measurements associated with the advanced static laboratory testing program are tabulated on the summary of the respective advanced laboratory test results. Most of these results are plotted on the boring logs (Plates I-2 and I-3). The specific gravity of the soil solids is tabulated in Additional Classification Test Results on Plate B-3 for Boring AT13#2, and on

[Plate B-18](#) for Boring KC151#3. Results of the hydrometer analyses are plotted on the grain-size distribution curves on [Plates B-4](#) and [B-19](#) for Borings AT13#2 and KC151#3, respectively.

Conventional Strength Tests

Four procedures were used in the conventional laboratory investigation to determine the undrained shear strengths of the soils encountered in the borings. Undisturbed shear strengths of cohesive soil samples were determined in the field with a motorized miniature vane shear device while soil samples were still in the sample liner. Torvane, pocket penetrometer and UU triaxial compression tests were also performed in the field on extruded soil samples. Miniature vane shear tests on remolded samples were performed on selected soil samples in the field. The results of these strength tests, which are plotted on the boring logs, are tabulated in the Summary of Test Results, presented on [Plates B-2](#) and [B-17](#) for Borings AT13#2 and KC151#3, respectively. The test procedures to determine the undrained shear strength of the samples are described in the following paragraphs.

Torvane Tests. A small hand-operated device, consisting of a metal disc with thin, radial vanes projecting from one face, was pressed against a flat surface of the soil until the vanes were fully embedded. The device was then rotated through a torsion spring until the soil was sheared. The device was calibrated to indicate the undrained shear strength of the soil directly from the rotation of the torsion spring.

Pocket Penetrometer Tests. The pocket penetrometer is a small, hand-held device consisting of a flat-faced cylindrical plunger and spring encased in a cylindrical housing. The plunger is pressed against a flat soil surface, compressing the spring until the soil experiences a punching type bearing failure. The penetrometer is calibrated to indicate shear strength of the soil directly from compression of the spring.

Miniature Vane Shear Tests. In performing the miniature vane shear test, a small, four-bladed vane was inserted into an undisturbed or remolded cohesive specimen. Torque was applied to the vane through a calibrated spring activated by a motorized pulley and belt system, causing the vane to rotate slowly until soil shear failure occurs. The undisturbed or remolded shear strength of the soil was computed from the torque transmitted by the calibrated spring by multiplying the net rotation, in degrees, by the spring calibration factor. The maximum undrained shear strength that can be measured by the miniature vane shear device is about ~168 kPa (3.5 ksf).

Unconsolidated-Undrained Triaxial Compression Tests. In this type of strength test, either an undisturbed or remolded soil specimen is enclosed in a thin rubber membrane and subjected to a confining pressure. Because of the high total stresses in the sediments and the cell pressure limitation (2.7 MPa or 90 psi) of the triaxial set-up, confining pressures for the triaxial tests were taken as ~690 kPa (100 psi) at the mudline and increased at a rate of ~7 kPa (1 psi) per ~30 cm (1-ft) penetration. This methodology has, in the past, given good correlation of UU triaxial test data with miniature vane and in situ vane shear data in deepwater investigations. The test specimen is not allowed to consolidate under the influence of this confining pressure prior to testing. The specimen is then loaded axially to failure at a strain rate of 1 percent per minute without allowing drainage from the specimen. The undrained shear strength of cohesive soils is computed as one-half the maximum observed deviator stress.

Undisturbed shear strengths determined by this type of test were only performed for a few samples obtained from Boring KC151#3, and are tabulated on the Summary of Test Results, [Plate B-17](#), together with the confining pressure, the ϵ_{50} value, percent strain at failure and type of failure from undisturbed UU triaxial compression tests. Normalized stress-strain curves from the undisturbed UU triaxial compression tests are presented on [Plate B-20](#).

One-Dimensional Consolidation Tests

A total of twelve (12) controlled-rate-of-strain (CRS) one-dimensional consolidation tests were performed on samples from Borings AT13#2 and KC151#3 to investigate the stress history and mechanical consolidation properties of the soils. The test specimens were selected from FHPC and FC liner sub-samples, and samples judged to have undergone minimal disturbance. With the FHPC and FC liner samples, the x-ray radiographs (Appendix C) were reviewed to determine the apparent quality of soil available for testing. Selected portions of the FHPC and FC liner samples were then cut into segments with a mechanical hacksaw blade to obtain individual test specimens. A wire saw was used to separate the soil specimens from the surrounding liner. Summaries of the one-dimensional consolidation test results for Boring AT13#2 are presented on Plate B-5, with individual test data plots presented on Plates B-6 and B-7. Summaries of the one-dimensional consolidation test results for Boring KC151#3 are presented on Plate B-21 with individual test data plots presented on Plates B-22 through B-31.

Controlled Rate of Strain (CRS) Consolidation Tests. Each CRS consolidation test specimen was trimmed into a stainless steel ring of 63.5 mm (2.5-in.) diameter. The test specimen was then placed in a specially made pressure cell. The base of the test specimen was sealed from the fluid (water), and the top of the specimen was exposed to the fluid. A porous stone was placed on top of the test specimen and the loading ram was brought into contact with the porous stone. As the test specimen was compressed during loading, the pore fluid exited from the sample through the porous stone. A pressure transducer was connected to the bottom of the specimen, through the cell, to measure the excess pore pressure during loading. The set-up of the test specimen into the cell was performed with the entire cell under water so that there was no air trapped in the system that would affect the pore pressure response during loading.

After the cell had been fully assembled, it was placed in a loading frame where the test specimen was back-pressure saturated. A seating stress of about ~5 kPa (0.7 psi) was applied to initialize the deformation indicator. Next, the specimen was deformed to an axial strain of 0.2 percent and back-pressure saturated without allowing the specimen to swell. The applied back-pressure was typically in the range of about 483 kPa (70 psi). After saturation, the specimen was deformed at a controlled rate of strain (i.e., constant rate of strain) while monitoring the pore-water pressure, axial deformation, and axial force. A computer program monitored the data, and the deformation rate was adjusted (only if required) to maintain a pore-water pressure ratio between 3 and 10 percent. A limit of 10 percent pore-water pressure ratio (in lieu of 30 percent specified in the ASTM D 4186-89) was selected to obtain more reliable compressibility and rate of consolidation coefficients.

The specimen was loaded into what appeared to be the virgin consolidation region (about 15 to 20 percent strain). An unload-reload cycle of about one log cycle of stress was then initiated, and loading continued until approximately 25 percent strain or a maximum pressure of about 2.3 MPa (48 ksf) was reached, whichever occurred first.

The laboratory measured maximum past stress ($\sigma'_{v,m}$) applied to the test specimen was interpreted from the consolidation curve using Casagrande's (1936) procedures and the work-per-unit-volume method (Becker et al, 1987). The data plots presented include curves of axial strain (ϵ_a) and coefficient of consolidation (C_v) versus natural logarithm of effective vertical stress ($\log \sigma'_v$). The tests were run in general accordance with ASTM D 4186-89.

Static Direct Simple Shear (DSS) Tests

The K_0 -consolidated, constant volume (undrained), strain-controlled, direct simple shear tests (CK₀U'-DSS) were conducted using a Marshal Silver type device. The test specimens were selected primarily from FHPC and FC liner samples. A total of eleven (11) CK₀U'-DSS tests were performed for this study.

Each test was performed on trimmed specimen having a diameter of 66.5 mm (2.62-in.) and a height of about 17.8 mm (0.70-in.). The test specimen was laterally confined using a wire-reinforced rubber membrane. In accordance with the SHANSEP methodology, the test specimen was incrementally consolidated to the maximum vertical effective stress (about 1.5 to 3.0 times the estimated preconsolidation stress) to induce an overconsolidation ratio (OCR) of 1. A load increment ratio (LIR) of one was typically used and each increment was maintained for $t_{90} + 1$ hour, while the last increment (OCR = 1) was maintained constant for about 24 hours prior to shearing. No correction was made for the effects of the wire-reinforced rubber membrane.

Each specimen was sheared at a controlled rate of strain of about 5 percent per hour. Vertical and horizontal loads on the sample were measured with load transducers while horizontal deformations were measured by an LVDT. During shear, the specimen was maintained in an undrained (constant volume) state by keeping the height of the specimen constant. The change in vertical stress during shear was used to estimate pore pressure changes in the sample.

Summaries of the CK_0U' -DSS test results for Boring AT13#2 are presented on [Plate B-8](#), with individual test data plots presented on [Plates B-12](#) and [B-13](#). Summaries of the CK_0U' -DSS test results for Boring KC151#3 are presented on [Plate B-32](#), with individual test data plots presented on [Plates B-33](#) through [B-41](#). The data plots presented include curves of normalized shear stress ($c_u/\sigma'_{v,c}$) versus shear strain (γ), normalized decrease in vertical stress ($\Delta\sigma'_v/\sigma'_{v,c}$) versus shear strain (γ), and normalized stress path ($c_u/\sigma'_{v,c}$) versus normalized effective vertical stress ($\sigma'_v/\sigma'_{v,c}$).

SHANSEP Procedure for Shear Strength Interpretation

The SHANSEP procedure, proposed by Ladd and Foott (1974), was used as an alternative method of in situ shear strength evaluation. This is a design methodology developed at the Massachusetts Institute of Technology (MIT) for evaluating the in situ strength and deformation properties of clay deposits. It recognizes the stress history of the deposit and, hence, the state of consolidation of the deposit. The method employs laboratory test procedures specifically aimed at reducing the adverse effects of sample disturbance. The purpose of these tests is to determine whether the stress-strain characteristics of the soils can be normalized and, if so, to obtain the normalized shear strength parameter, $c_u/\sigma'_{v,c}$ (where c_u is the peak undrained shear strength measured by the test, and $\sigma'_{v,c}$ is the effective vertical consolidation pressure). The normalized parameter ($c_u/\sigma'_{v,c}$) should be developed for a range of stress conditions that are representative of the stress history of the soil in the field. Since high-quality oedometer tests are essential, particularly in overconsolidated soil, good undisturbed samples are a major requirement.

Analytically, the SHANSEP procedure includes the following steps:

- (1) Examine and subdivide the subsoils on the basis of all available information, such as boring logs and vane shear data. Investigate the stress history of the soil profile using a program of total unit weight, pore pressure, and maximum preconsolidation pressure measurements.
- (2) Decide on the shear strength tests that best model the design loading conditions (triaxial compression, triaxial extension, simple shear, etc.). Investigate whether the cohesive soil exhibits normalized behavior by first reconsolidating the test specimens back to the virgin compression line (i.e., OCR=1) to a pressure approximately 1.5 to 3.0 times the laboratory measured maximum past stress ($\sigma'_{v,m}$). Shear representative samples to measure the normalized value, $c_u/\sigma'_{v,c}$. A clay exhibiting normalized behavior will yield a relatively constant value of $c_u/\sigma'_{v,c} \pm 10\%$.

- (3) If the clay does exhibit normalized behavior, induce desired OCR values to the rest of the samples to model field stress history (by unloading samples of OCR=1) and then shear them to obtain the $c_u/\sigma'_{v,c}$ parameter for different OCR values. Develop the "m" parameter of the following equation by regression analysis of test results.

$$S_u = \left(\frac{c_u}{\sigma'_{v,c}} \right)_{nc} \times (\text{OCR})^m \times \sigma'_{v,sub}$$

where: $\left(\frac{c_u}{\sigma'_{v,c}} \right)_{nc}$ = normalized undrained shear strength ratio at OCR=1;

$\sigma'_{v,c}$ = effective vertical consolidation pressure;

$\sigma'_{v,sub}$ = effective hydrostatic overburden stress;

OCR = overconsolidation ratio obtained from one-dimensional consolidation test; and

m = strength increase exponent, which depends on type of cohesive soil and type of shear test.

Since the "m"-parameter usually shows a very narrow variance over a wide range of soils tested, a modified SHANSEP procedure that eliminates time-consuming testing at various OCRs to obtain "m" is commonly used. In the modified SHANSEP test procedure, all samples are sheared at an OCR of 1.0 and "m" is taken as 0.8 (Ladd et al, 1977).

TruePath™ K₀ Consolidated-Undrained Triaxial Extension Tests

A total of four (4) TruePath™ K₀ consolidated-undrained triaxial test with shearing in extension (TPK₀U'-TE) were performed for this study. Each test was performed using an automated system (TruePath™) developed by Fugro Consultants LP, Trautwein and Germaine of MIT. The test procedure followed the technical requirements of ASTM Test Method D 4767-02 except for (a) the TruePath™ K₀ consolidation, (b) some minor calculation methodologies (volume of specimen before shearing, membrane correction, and area correction during shearing), and (c) shearing in extension.

Each specimen, 51.0 mm (2.0-in.) in diameter and 102 mm (4.0-in.) in height, had top, bottom, and radial drainage boundaries during consolidation. The radial drainage was provided by spirally oriented 6 mm (1/4-in.) wide, Whatman No. 1 filter strips placed at about 6 mm (1/4-in.) spacing.

Each specimen was prepared and mounted in the triaxial testing apparatus. Specimen saturation was achieved through back pressuring at, either an effective isotropic-confining stress of ~21 kPa (3 psi) to ~48 kPa (7 psi), a stress which prevents swelling, or the assigned stress, whichever was smaller. Using the SHANSEP methodology, the specimen was K₀ consolidated to OCR = 1 condition at a controlled rate of strain of approximately 0.2 percent per hour. Upon reaching the assigned vertical-effective stress, ($\sigma'_{v,c}$) or an axial strain of at least 10 percent, the applied stress was maintained constant for a curing period of approximately 24 hours (simulated aging).

During the shear phase, the chamber pressure was kept constant and specimen drainage was not permitted. An axial loading piston was retracted from (shearing in extension) the cell at a pre-set rate-of-strain. The applied rate-of-strain was slow enough (~0.5 %/hr) to produce approximate equalization of excess-pore water pressure (PWP) throughout the specimen at failure. The static stresses and PWPs were used to express the measured stress parameters in terms of effective stresses.

Time, load, deformation, PWP, and transducer excitation-voltage were measured and recorded during shearing using a data acquisition system. A customized Excel worksheet, along with a Visual Basic program, was used to process the raw data. Test data were corrected for the effects of weight of the top cap and the strength of the rubber membrane. The use of an internal force transducer and Whatman No. 1 spiral strips eliminated the need to correct test data for effects from filter paper strips, and for piston-friction and piston-uplift forces.

A summary of the TPK₀U¹-TE test results is presented on Plates B-11 and B-42, with the individual test data plots presented on Plates B-12 and B-13, and Plates B-43 and B-44 for Borings AT13#2 and KC151#3, respectively. The plots presented include curves of normalized shear stress ($q/\sigma'_{v,c}$), normalized excess PWP ($\Delta U/\sigma'_{v,c}$), and obliquity versus axial strain (ϵ_a), axial strain (ϵ_a) and K_0 versus effective vertical stress ($\sigma'_{v,c}$) during 1-D consolidation, and normalized shear stress ($q/\sigma'_{v,c}$) versus normalized effective average principle stress ($p'/\sigma'_{v,c}$).

Hydraulic Conductivity (Permeability) Tests

The permeability tests (S₂-CI-HC-VHR) procedure meets or exceeds the technical requirements of ASTM Test Method D 5084-03 and Method F. Each test series typically consisted of three (3) tests on the same soil/material in a given sequence of how the test specimen was prepared. In the first stage, the specimen's orientation was such that its vertical permeability was determined, while in the second stage, the specimen's orientation and permeation was such that its horizontal permeability was determined. For the third stage, the specimen was thoroughly remolded. In each test, permeability determinations were done at two effective isotropic consolidation stress levels representing approximately 1/3 and 2/3 of the approximate in situ vertical effective stress ($\sigma'_{v,o}$).

Specimen saturation was achieved through back pressuring at either an effective isotropic-confining stress of 34.5 kPa (5 psi), a stress which prevents swelling, or the assigned stress, whichever was smaller. The test specimen was then isotropically consolidated in increments to the first level of effective isotropic-consolidation stress. Permeation was accomplished using a falling-head constant-volume hydraulic system (Trautwein Permeameter and Permometer). This constant-volume system ensures the continuity of inflow and outflow of permeant water during each hydraulic conductivity determination.

The extruded specimen was trimmed to 64 mm (2.5-in.) diameter and a height of about 51 to 64 mm (2.0 to 2.5-in.), placed in a flexible-wall permeameter (triaxial cell), and tested as discussed previously. The trimmings were saved in a sealed container. Upon completion of the vertical permeability measurements, the drainage lines were closed, the cell pressure and backpressure were removed, the triaxial cell was disassembled and the test specimen was removed.

A 38 to 51 mm (1.5 to 2.0-in.) diameter by 51 mm (2.0-in.) high specimen was then trimmed from the original specimen so that the central axis of the new specimen was perpendicular to that of the old specimen. The newly trimmed specimen was tested in the manner discussed above to determine its horizontal permeability at the same two levels of isotropic consolidation stress.

Upon completion of the horizontal permeability measurements, the specimen and all of the previously obtained trimmings were combined and thoroughly remolded in a rubber membrane. This remolded soil was formed into a roughly shaped cylinder having a diameter slightly greater than 51 mm (2.0-in.). After removing the rubber membrane, the soil was placed into an expanded split-cylinder mold, 51 by 51 mm (2.0- by 2.0-in.), then the mold was clamped around the soil and the soil was trimmed and flushed with the ends of the mold. Finally, the soil was extruded and tested in a manner consistent with previous vertical and horizontal permeability tests.

A summary of the hydraulic conductivity test results is presented on Plates [B-14](#) and [B-45](#) for Borings AT13#2 and KC151#3, respectively. Plots of void ratio (e) versus hydraulic conductivity for vertical, horizontal, and/or remolded conditions for each test series is presented on [Plate B-15](#) for Boring AT13#2, and on Plates [B-46](#) through [B-48](#) for Boring KC151#3. Each plot provides a comparison of how hydraulic conductivity changes with void ratio and vertical, horizontal, and/or remolded conditions.

APPENDIX B
ILLUSTRATIONS

LABORATORY TESTS			
Classification Tests		Offshore	Onshore
Moisture Content		10	16
Submerged Unit Weight		9	7
Atterberg Limits		16	
Hydrometer Analysis		6	
Specific Gravity		6	
Shear Strength Tests		Offshore	Onshore
Torvane		9	---
Pocket Penetrometer		---	---
Miniature Vane	<i>Undisturbed</i>	17	---
	<i>Remolded</i>	8	---
Unconsolidated-Undrained Triaxial Test	<i>Undisturbed</i>	---	---
	<i>Remolded</i>	---	---
CK₀U'-DSS <i>Static DSS Test</i>	<i>Undisturbed</i>	2	
TPK₀U'-TE <i>True Path™ K₀ Triaxial Extension Test</i>	<i>Undisturbed</i>	2	
1-D Consolidation Tests			
Undisturbed CRS		2	
Hydraulic Conductivity Tests			
Permeability Tests	<i>Vertical</i>	1	
	<i>Horizontal</i>	1	
	<i>Remolded</i>	1	

Note: All tests, except those indicated as "Offshore", were performed at Fugro's Houston laboratory.

SUMMARY OF TYPE AND NUMBER OF TESTS

Boring AT13#2

CVX Gulf of Mexico Gas Hydrates JIP

Block 13, Atwater Valley Area, Gulf of Mexico

Checked By:
Approved By:

Date:
Date:

Drawn By:

Date:

Summary of Test Results

Job No: 0201-5081-1

05-Jan-2006 (Ver. #11)

Block No: 13

Boring: AT13#2

Area: Atwater Valley Area

Sample No.	Depth (m)	Identification Tests						Strength Estimate (kPa)		Miniature Vane Tests (kPa)			Compression Tests								
		Liquidity Index	Liquid Limit (%)	Plastic Limit (%)	Moisture Content (%)	Submerged Unit Weight (kN/m ³)	Passing No. 200 Sieve (%)	Penetrometer	Torvane	Undisturbed	Remolded	Residual	Type Test	Moisture Content (%)	Confining Pressure (kPa)	Undisturbed Strength (kPa)	Remolded Strength (kPa)	ε ₅₀ Strain (%)	Submerged Unit Weight (kN/m ³)	Failure Strain (%)	Type of Failure
1	2.16					5.26			7	7											
2	2.29				72		99			7											
2	2.29	.70	80	24	63																
2	2.29										8										
3	6.16					6.20			13	19+											
4	6.31										12										
4	6.31				63					19											
4	6.31	.59	77	23	55																
5	8.14					5.67			12	19											
6	8.29	.54	80	23	54																
6	8.29										9										
6	8.29				64		99			15											
7	14.14					5.84			13	11											
8	14.30				57					16											
8	14.30	.57	82	24	57																
8	14.30										15										
9	19.45				80				14												
10	19.60										12										
10	19.60	.51	77	25	52	5.79	99			25											
11	23.44				56		99		16	33											
11	23.44	.55	76	24	52				18												

Notes:

TYPE OF TEST
 U - Unconfined Compression
 UU- Unconsolidated-Undrained Triaxial
 CU- Consolidated-Undrained Triaxial

TYPE OF FAILURE
 A - Bulge
 B - Single Shear Plane
 C - Multiple Shear Plane
 D - Vertical Fracture

Plus Signs [+] denote tests which exceeded the capacity of the measuring device.

NP = Non Plastic Material



Checked By:
Approved By:

Date:
Date:

Drawn By:

Date:

Report No. 0201-5081 (Appendix B)

Summary of Test Results

Job No: 0201-5081-1

05-Jan-2006 (Ver. #11)

Block No: 13

Boring: AT13#2

Area: Atwater Valley Area

Sample No.	Depth (m)	Identification Tests						Strength Estimate (kPa)		Miniature Vane Tests (kPa)			Compression Tests								
		Liquidity Index	Liquid Limit (%)	Plastic Limit (%)	Moisture Content (%)	Submerged Unit Weight (kN/m ³)	Passing No. 200 Sieve (%)	Penetrometer	Torvane	Undisturbed	Remolded	Residual	Type Test	Moisture Content (%)	Confining Pressure (kPa)	Undisturbed Strength (kPa)	Remolded Strength (kPa)	ε ₅₀ Strain (%)	Submerged Unit Weight (kN/m ³)	Failure Strain (%)	Type of Failure
12	23.59					5.60				25											
13	29.54				79																
14	32.31	.49	79	23	51	5.61	99		17	5											
15	32.46				54																
15	32.46										6										
18	41.30					6.03			27	29											
19	41.45										20										
19	41.45				56		100		28	39											
19	41.45	.43	84	23	49																
16	48.01									27											
17	48.16				50	6.46				32											
17	48.16	.39	86	23	47																
17	48.16										30										

PLATE B-2b

Notes:

TYPE OF TEST
 U - Unconfined Compression
 UU- Unconsolidated-Undrained Triaxial
 CU- Consolidated-Undrained Triaxial

TYPE OF FAILURE
 A - Bulge
 B - Single Shear Plane
 C - Multiple Shear Plane
 D - Vertical Fracture

Plus Signs [+] denote tests which exceeded the capacity of the measuring device.

NP = Non Plastic Material



Sample Number	Depth		Specific Gravity
	[mbsf]	[ft BML]	
2	2.29	7.5	2.761
6	8.29	27.2	2.771
10	19.60	64.3	2.734
11	23.44	76.9	2.753
14	32.31	106.0	2.742
19	41.45	136.0	2.780

ADDITIONAL CLASSIFICATION TEST RESULTS
Boring AT13#2
Specific Gravity Test Results
CVX Gulf of Mexico Gas Hydrates JIP
Block 13, Atwater Valley Area, Gulf of Mexico

Checked by:

Date:

Drawn by:

Date:

Approved by:

Date:

Report No.: U201-5081 (Appendix B)

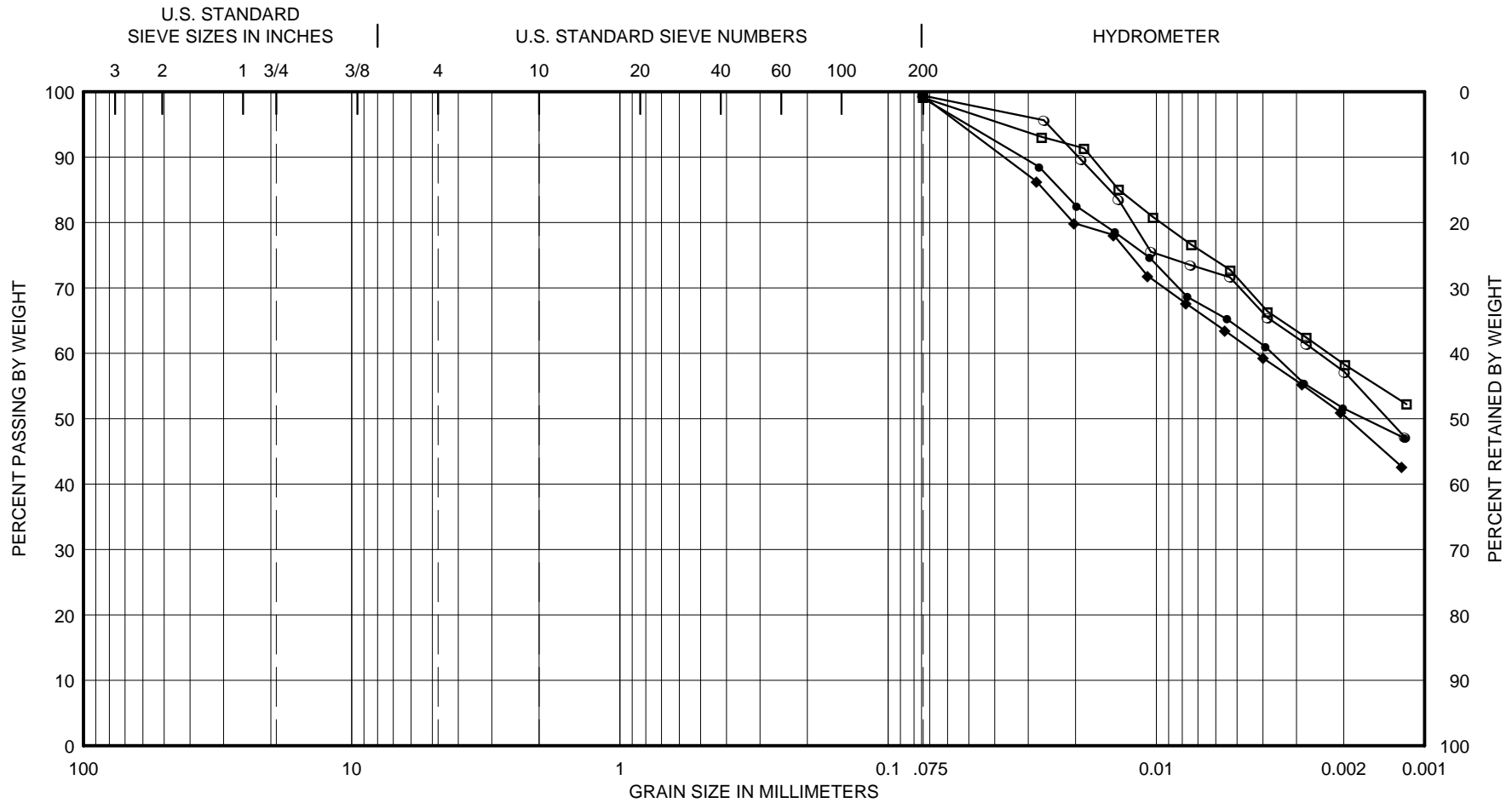

GRAVEL		SAND			SILT or CLAY
Coarse	Fine	Coarse	Medium	Fine	

SAMPLE NO.	DEPTH, M	SYMBOL	CLASSIFICATION
2	2.29	o	Fat Clay (CH), olive gray
6	8.29	□	Fat Clay (CH), olive gray w/ brown
10	19.60	◆	Fat Clay (CH), olive gray w/ dark gray
11	23.44	●	Fat Clay (CH), olive gray

GRAIN-SIZE DISTRIBUTION CURVES

Boring AT13#2

CVX Gulf of Mexico Gas Hydrates JIP

Block 13, Atwater Valley Area, Gulf of Mexico

PLATE B-4a



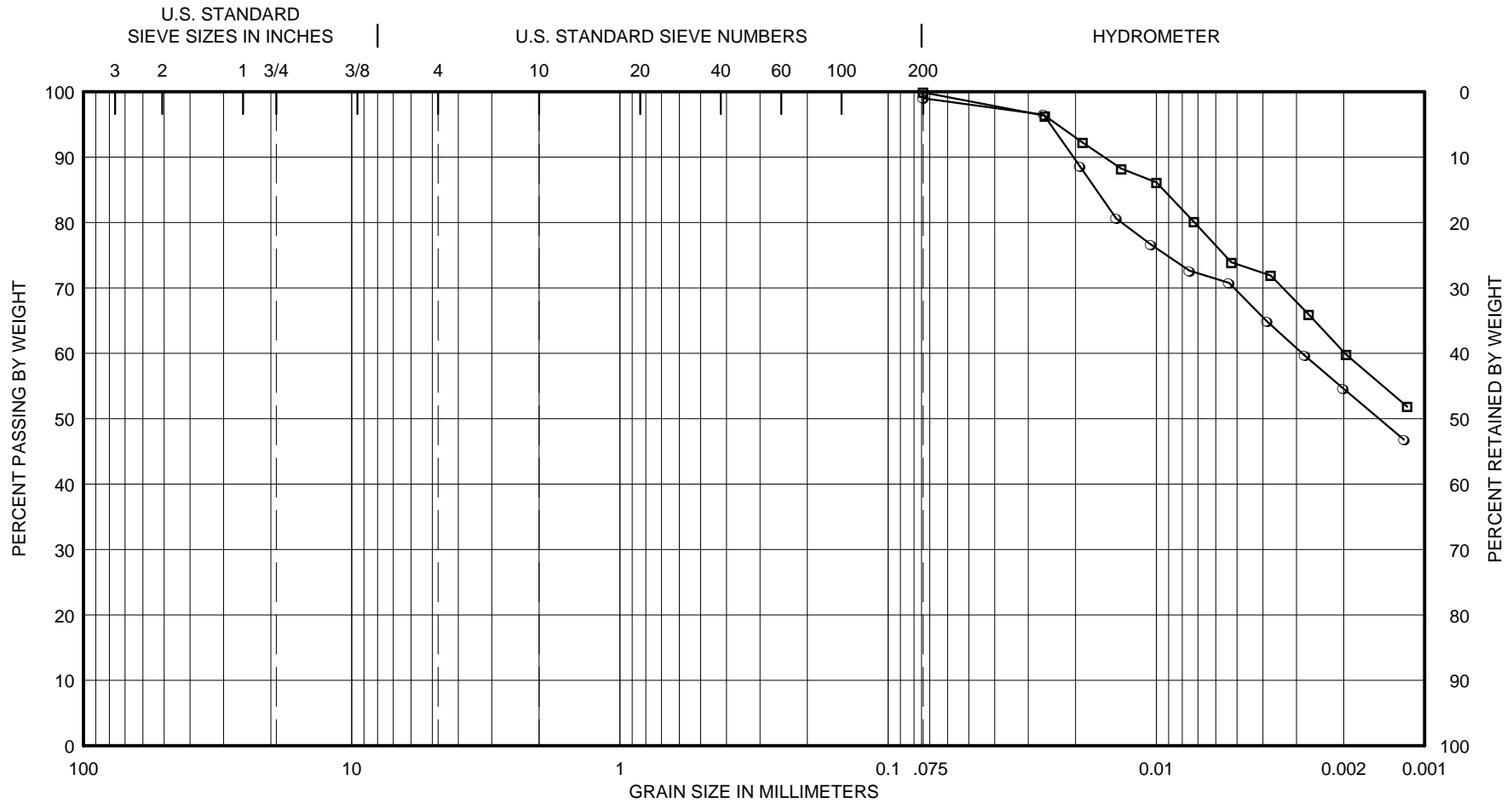

GRAVEL		SAND			SILT or CLAY
Coarse	Fine	Coarse	Medium	Fine	

SAMPLE NO.	DEPTH, M	SYMBOL	CLASSIFICATION
14	32.31	○	Fat Clay (CH), olive gray w/ dark gray and silty fine sand pockets
19	41.45	□	Fat Clay (CH), olive gray w/ dark gray

GRAIN-SIZE DISTRIBUTION CURVES

Boring AT13#2

CVX Gulf of Mexico Gas Hydrates JIP

Block 13, Atwater Valley Area, Gulf of Mexico



Series &/or Test No.	Boring - Sample - Spec. No.	Penetration or Depth (m)	Index Properties:					At Preconsol. Stress:		Compression Ratios:			Coeff. of Consol., c_v Virgin Loading (m^2/y)	Remarks: SB-Sharp Break RSB-Relatively SB MR-Mod. Rounded R-Rounded
			G_s	S_o (%)	LL PI	W_o (%) Ll_o	$\gamma_{t,o}$ (kN/m^3) e_o	Casagrande Method Becker Method ⁽¹⁾	σ'_p (kPa)	ϵ_a (%)	Virgin CR CR by LL (CR_{LL}) ⁽²⁾	Recomp. RR Swell (SR)		
1	AT13#2 10a	19.60	2.750	102.5	82	61.0	16.4	70.0	4.9	0.219	0.042	0.89	0.30 - 0.70	RSB-Relatively SB
					60	0.651	1.638	88.3		0.246	0.039	5.20		
2	AT13#2 14a	32.46	2.750	100.5	77	56.1	16.6	66.6	4.4	0.199	0.036	0.84	0.28 - 0.58	RSB-Relatively SB
					57	0.634	1.537	93.7		0.238	0.033	5.57		

No.	Description of Tested Soil, Test Remarks, and Supplemental Data:	Plate Number
1	Clay, dark gray with mass organic streaks	B-6
2	Clay, olive gray and dark gray with organic streaks	B-7

Notes: Indicates value was copied from adjacent test specimen or assumed.

⁽¹⁾ Estimated preconsolidation stress using the Work per Unit Volume method, as described by Becker, et al. (1987).

⁽²⁾ $CR_{LL} = ((LL - 10) \times 0.009) / (1 + e_o)$

SUMMARY OF 1-D CONSOLIDATION TESTS: VERSUS DEPTH

Boring AT13#2

Block 13, Atwater Valley Area, Gulf of Mexico



Date:

Drawn By:

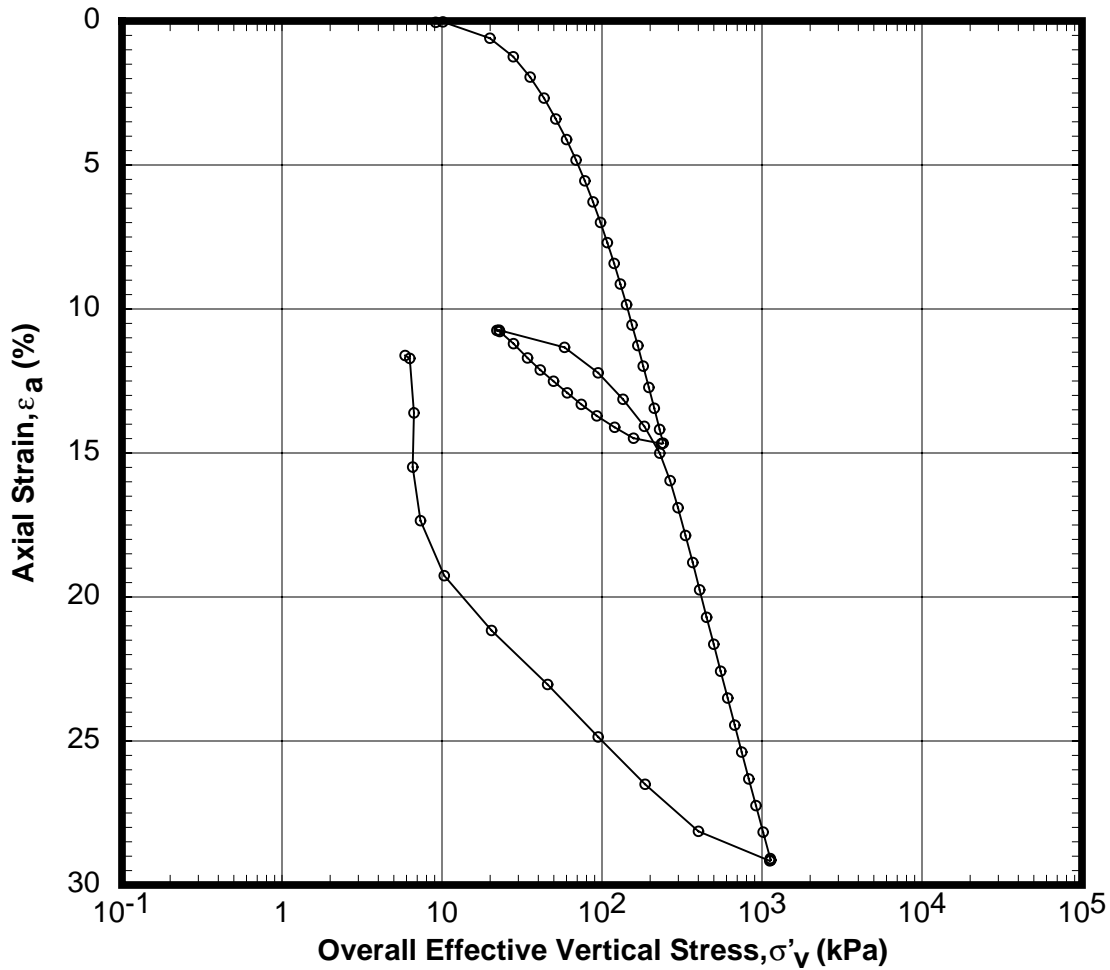

□ - Loading with solid symbols indicating
 ○ - Unloading (Final) reloading increments.

Date:

Date:

Checked By:

Approved By:

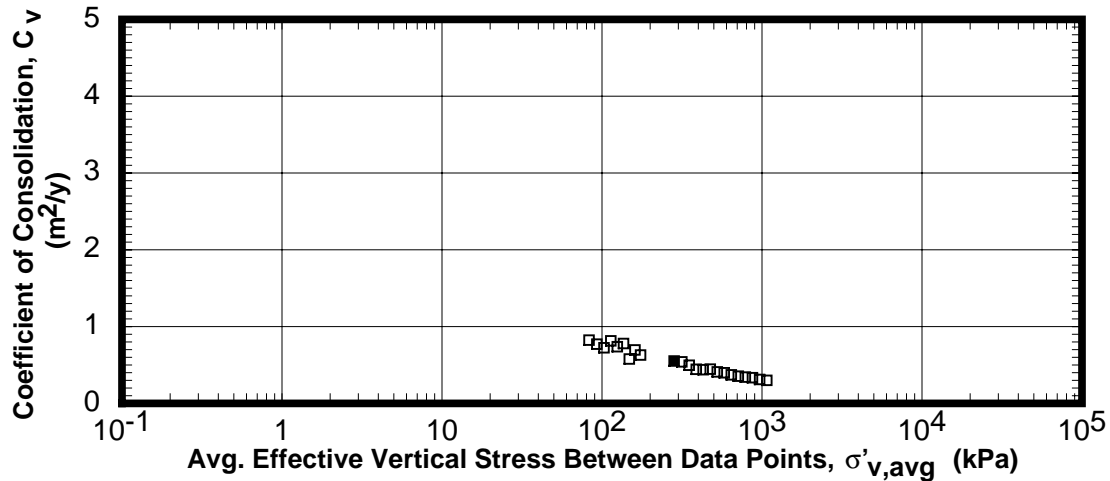

1-D CONSOLIDATION TEST: CRS
 Boring AT13#2 - Sample No. 10a - Depth 19.60 m
 CVX Gulf of Mexico Gas Hydrates JIP
 Block 13, Atwater Valley Area, Gulf of Mexico

Date:

Drawn By:

Date:

Date:

Checked By:

Approved By:

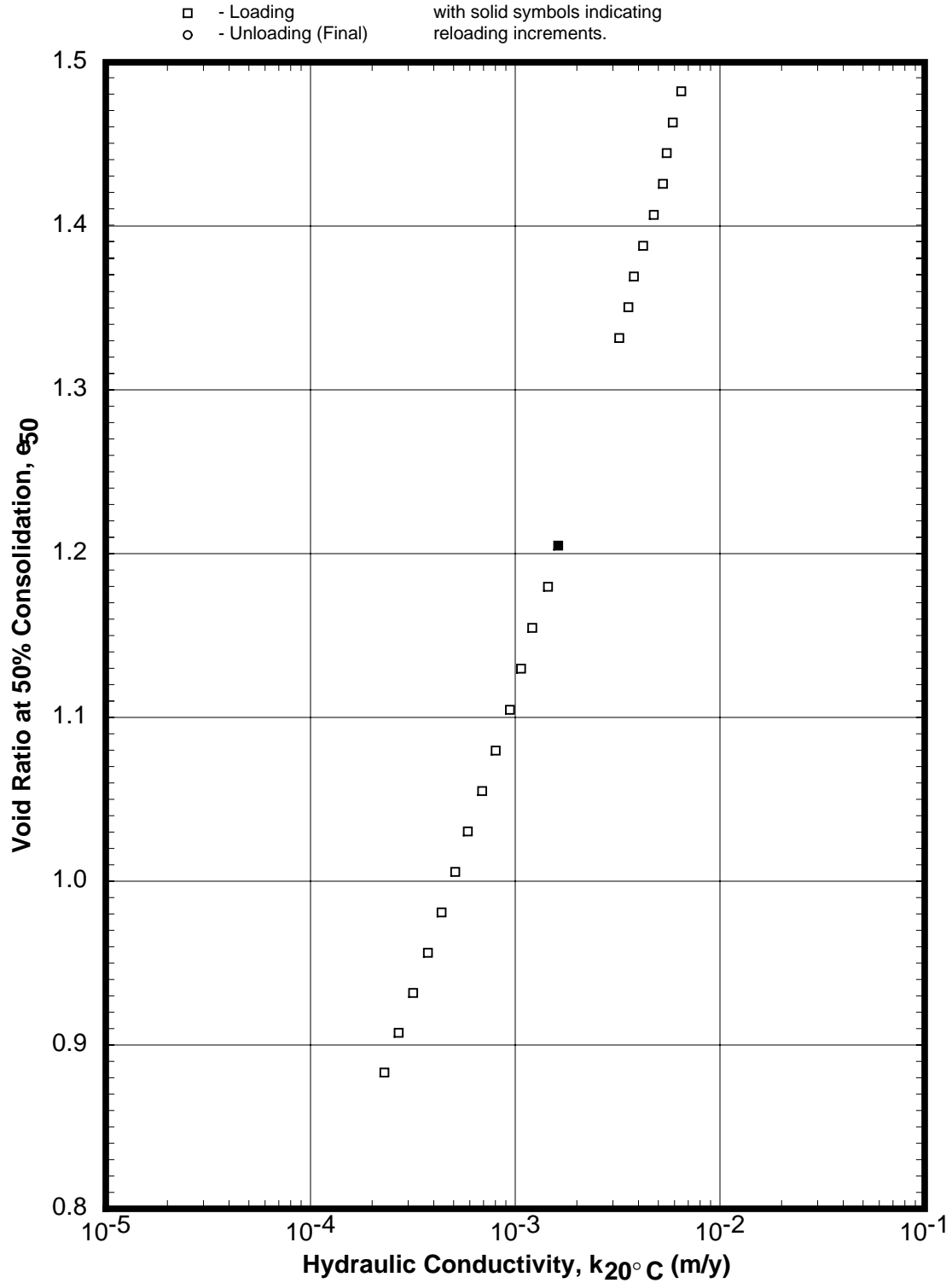

1-D CONSOLIDATION TEST: CRS
 Boring AT13#2 - Sample No. 10a - Depth 19.60 m
 CVX Gulf of Mexico Gas Hydrates JIP
 Block 13, Atwater Valley Area, Gulf of Mexico

Date:

Drawn By:

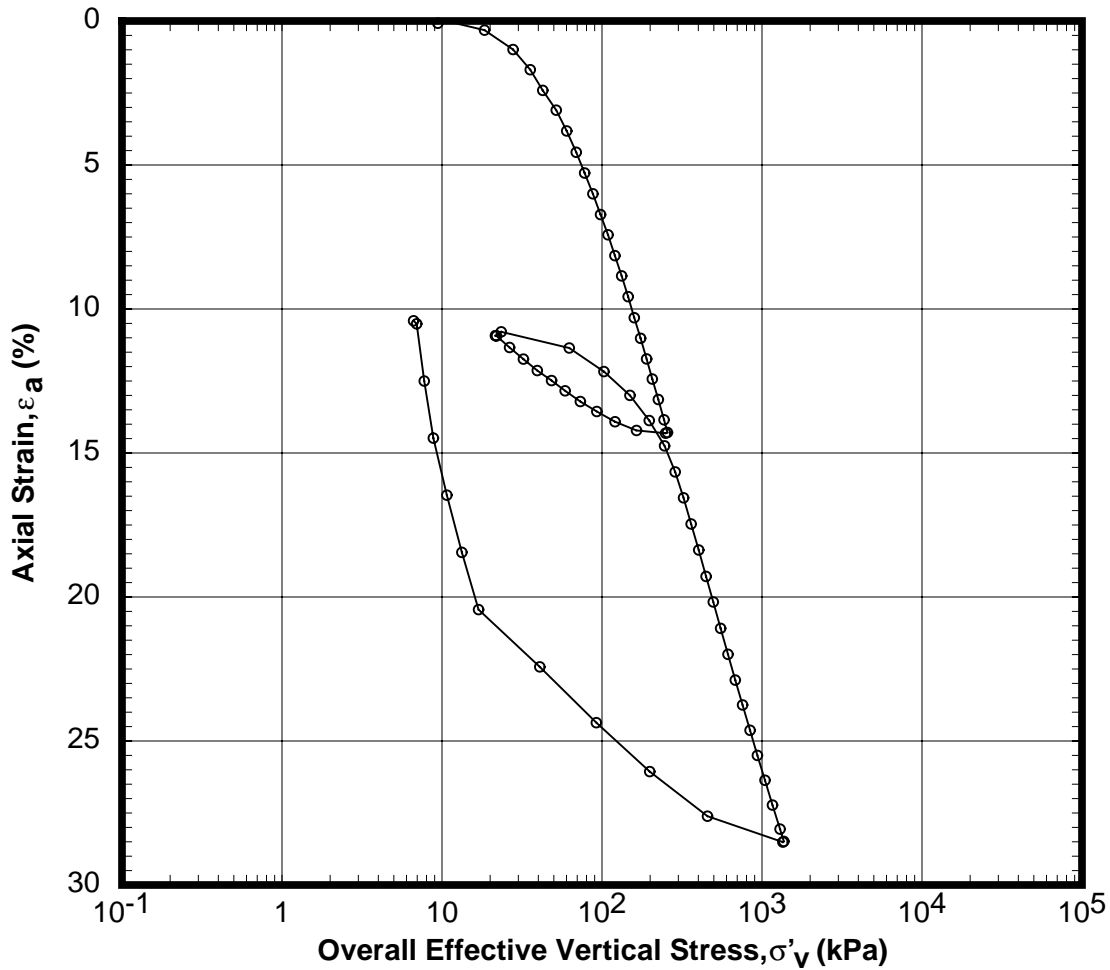

□ - Loading with solid symbols indicating
 ○ - Unloading (Final) reloading increments.

Date:

Checked By:
 Approved By:

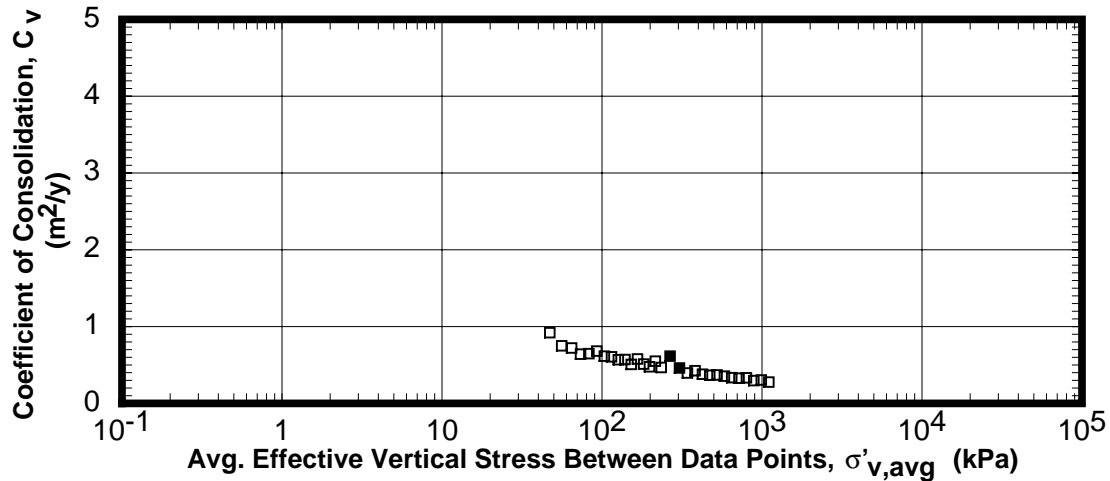

1-D CONSOLIDATION TEST: CRS
 Boring AT13#2 - Sample No. 14a - Depth 32.46 m
 CVX Gulf of Mexico Gas Hydrates JIP
 Block 13, Atwater Valley Area, Gulf of Mexico

□ - Loading with solid symbols indicating
 ○ - Unloading (Final) reloading increments.

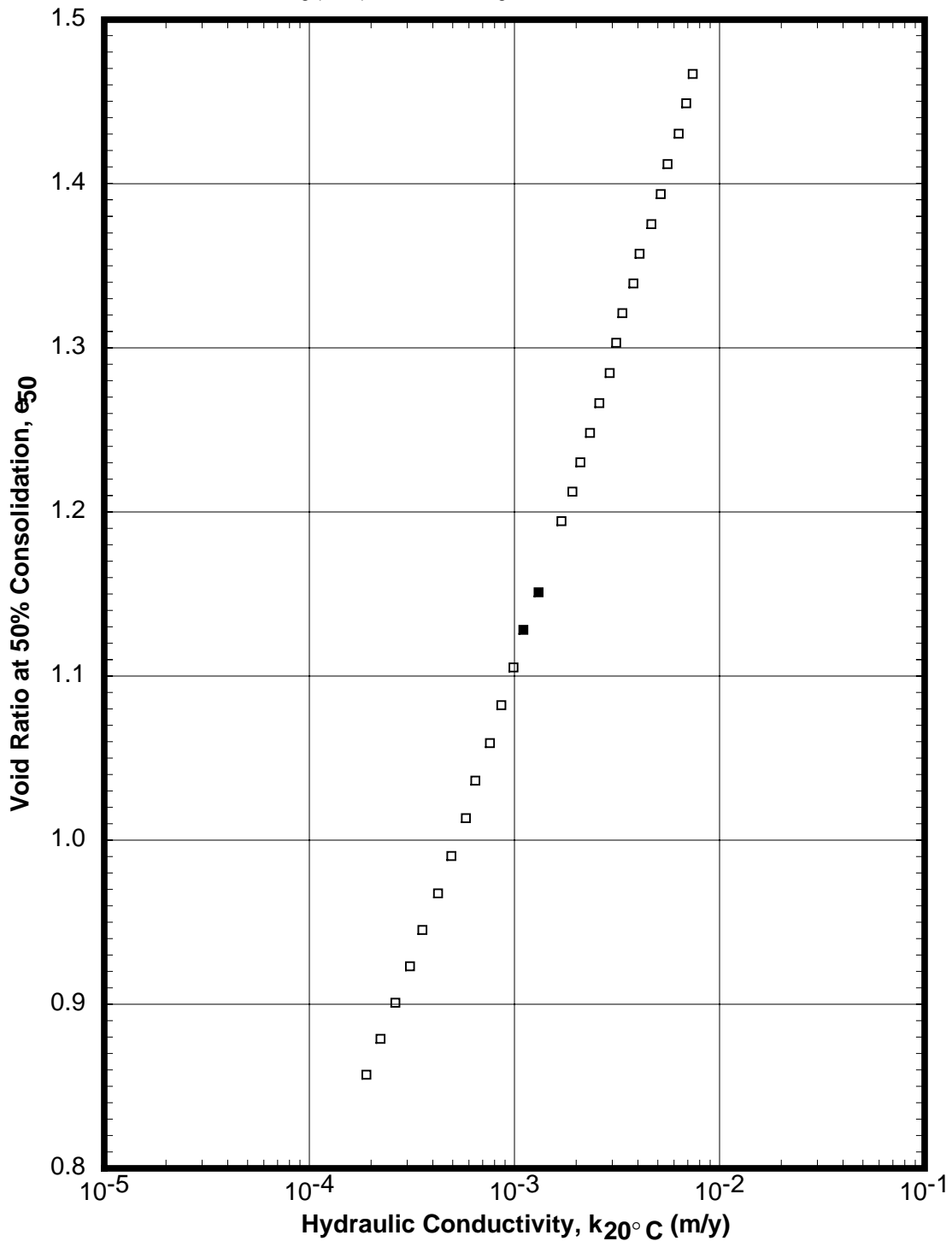

Date:

Drawn By:

Date:

Date:

Checked By:
 Approved By:

1-D CONSOLIDATION TEST: CRS
 Boring AT13#2 - Sample No. 14a - Depth 32.46 m
 CVX Gulf of Mexico Gas Hydrates JIP
 Block 13, Atwater Valley Area, Gulf of Mexico

Series &/or Test No.	Boring - Sample - Spec. No.	Penetration or Depth (m)	G _s	Index Properties:								at Peak Shear Stress				
				LL	w _o	γ _{t,o}	S _o	LI _o	σ' _{v,c} (kPa)	ε _{a,max}	γ _{rate} (%/hr)	at Peak Stress Ratio - High Strain				C _u / σ' _{v,c}
				PI	w _c (%)	γ _{t,c} (kN/m ³)	S _c (%)	LI _c	Induced OCR	ε _{a,c} (%)	t _c (days)	γ (%)	τ _h (kPa)	τ _h / σ' _v	Δ U / σ' _{v,c}	Ψ _{DSS} (degrees)
1	AT13#2 10b	19.57	2.750	83	58.6	16.3	99.8	0.587	144.4	11.89	5.0	18.5	41.321	0.473	0.395	0.286
				59	47.6	17.2	100.0	0.399	1.00	11.89	1.0	29.4	35.527	0.537	0.542	28.53
2	AT13#2 14b	32.43	2.750	80	54.1	16.4	97.5	0.554	146.8	11.33	5.0	15.4	41.704	0.501	0.434	0.284
				58	44.9	17.5	100.0	0.395	1.00	11.33	0.9	29.2	35.144	0.611	0.608	31.60
3																
4																
5																
6																

Test No.	Description of Tested Soil, Test Remarks, and Supplemental Data:	Plate No.
1	Clay, olive gray	B-9
2	Clay, olive gray	B-10
3		
4		
5		
6		

■ Indicates value was copied from adjacent test specimen or assumed.

SUMMARY OF STATIC DSS TESTS: VERSUS DEPTH

K_o Consolidation - OCR = 1

Boring AT13#2

Block 13, Atwater Valley Area, Gulf of Mexico



Date:

Drawn By:

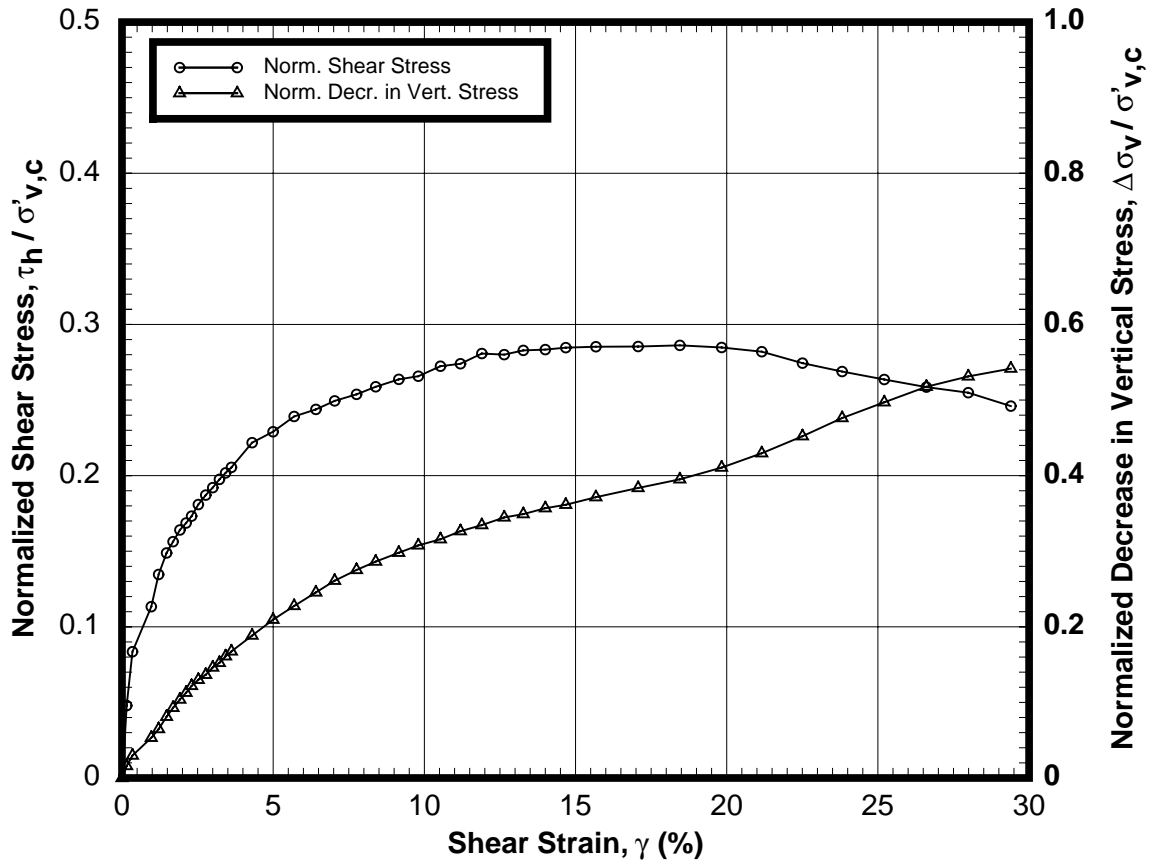

Date:

Date:

Checked By:

Approved By:

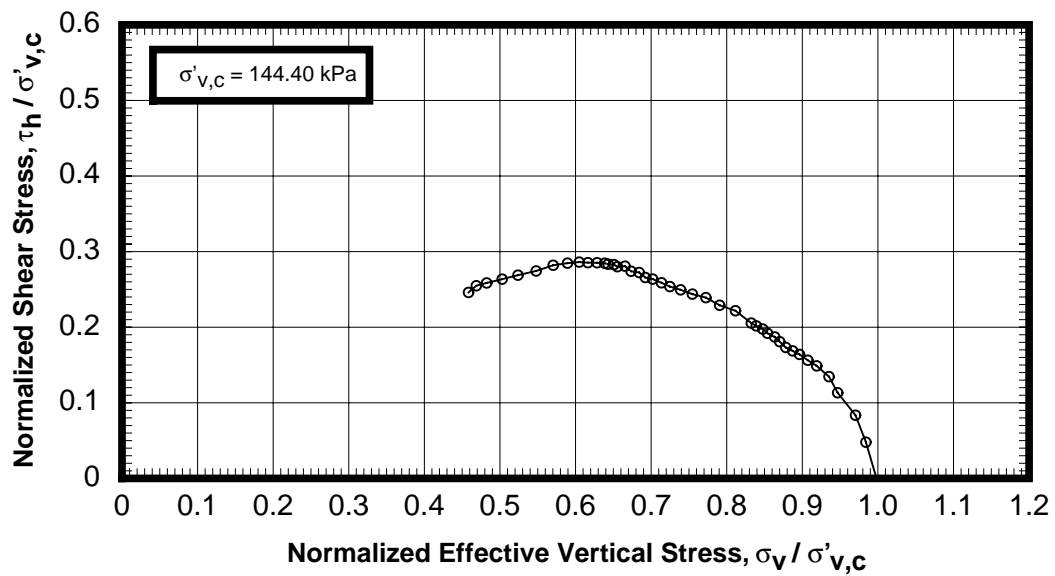

STATIC DSS TEST

K_0 Consolidation - OCR = 1

Boring AT13#2 - Sample No. 10b - Depth 19.57 m

CVX Gulf of Mexico Gas Hydrates JIP

Block 13, Atwater Valley Area, Gulf of Mexico

Date:

Drawn By:

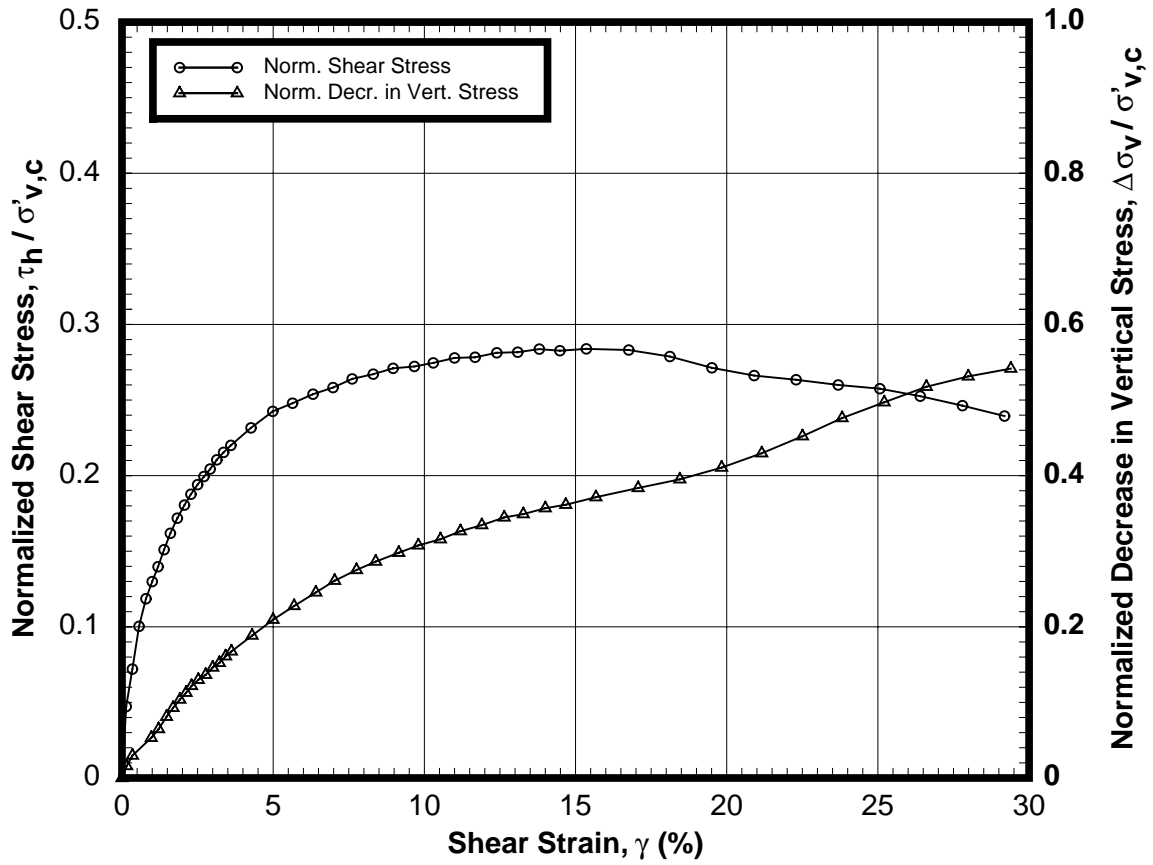

Date:

Checked By:
Approved By:

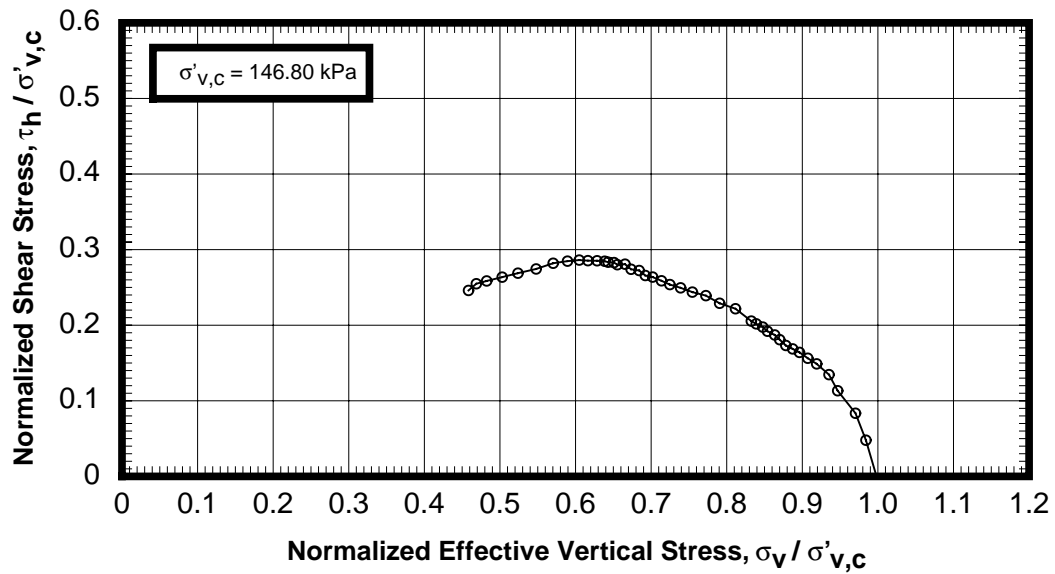

STATIC DSS TEST

K_0 Consolidation - OCR = 1
 Boring AT13#2 - Sample No. 14b - Depth 32.43 m
 CVX Gulf of Mexico Gas Hydrates JIP
 Block 13, Atwater Valley Area, Gulf of Mexico

Series &/or Test No.	Sample - Spec. No.	Penetration or Depth (m)	G _s	Index Properties:						σ' _{v,c} (kPa)	K ₀ = σ' _{h,c} /σ' _{v,c}	ε _{a,c} (%)	ε _{a,rate} (%/hr)	at Peak Shear Stress						c _u /σ' _{v,c} ⁽¹⁾
				LL	w _o	γ _{t,o}	S _o	LI _o	at Peak Stress Ratio (Obliquity)											
				PI	w _c (%)	γ _{t,c} (kN/m ³)	S _c	LI _c	Induced OCR					B-Value (%)	ε _{v,c} (%)	t _c (days)	ε _a (%)	q/σ' _{v,c}	p'/σ' _{v,c}	ΔU'/σ' _{v,c}
1	AT13#2 12a	23.59	2.750	79	57.8	16.5	100.6	0.614	235.6	0.59	14.8	-0.5	-14.7	-0.284	0.426	-0.119	5.007	0.210		
				55	43.6	17.6	100.2	0.357	1.00	107	14.8	3.0	-14.9	-0.283	0.420	-0.119	5.117	42.3		
2	AT13#2 18a	41.30	2.750	84	53.1	16.6	98.7	0.517	278.0	0.55	12.3	-0.5	-14.4	-0.244	0.442	-0.141	3.463	0.203		
				64	43.5	17.7	100.6	0.367	1.00	100	11.7	3.0	-13.2	-0.243	0.439	-0.135	3.488	33.7		
3	KC151#3 24(8C-2)a	216.62	2.750	71	32.4	18.3	93.6	0.196	1038.9	0.57	11.1	-0.5	-11.2	-0.198	0.445	-0.070	2.608	0.177		
				48	26.9	19.7	101.2	0.081	1.00	95	11.4	3.0	-10.4	-0.197	0.439	-0.065	2.629	26.7		
4	KC151#3 28(17H-3)a	258.99	2.750	82	39.4	17.3	92.8	0.240	1011.0	0.61	10.5	-0.5	-13.4	-0.234	0.533	-0.164	2.570	-0.210		
				56	37.5	18.2	99.5	0.204	1.00	95	6.2	4.0	-13.4	-0.234	0.533	-0.164	2.570	26.1		
5																				
6																				

Test No.	Description of Tested Soil , Test Remarks, and Supplemental Data	Back Pressure (kPa)	Plate No.
1	Clay, olive gray with ferrous shell fragments	339.0	B-12
2	Clay, olive gray with sand pockets	341.7	B-13
3	Clay, olive gray	340.9	B-43
4	Clay, olive gray with few sand pockets	478.9	B-44
5			
6			

Notes: Indicates value was copied from adjacent test specimen or assumed.

$$^{(1)} c_u = q_{u,f} \times \cos \phi'_{c=0}$$

SUMMARY OF STATIC TRUEPATH K₀ TRIAXIAL TESTS
 Boring AT13#2, Block 13, Atwater Valley Area
 Boring KC151#3, Block 151, Keathley Canyon Area



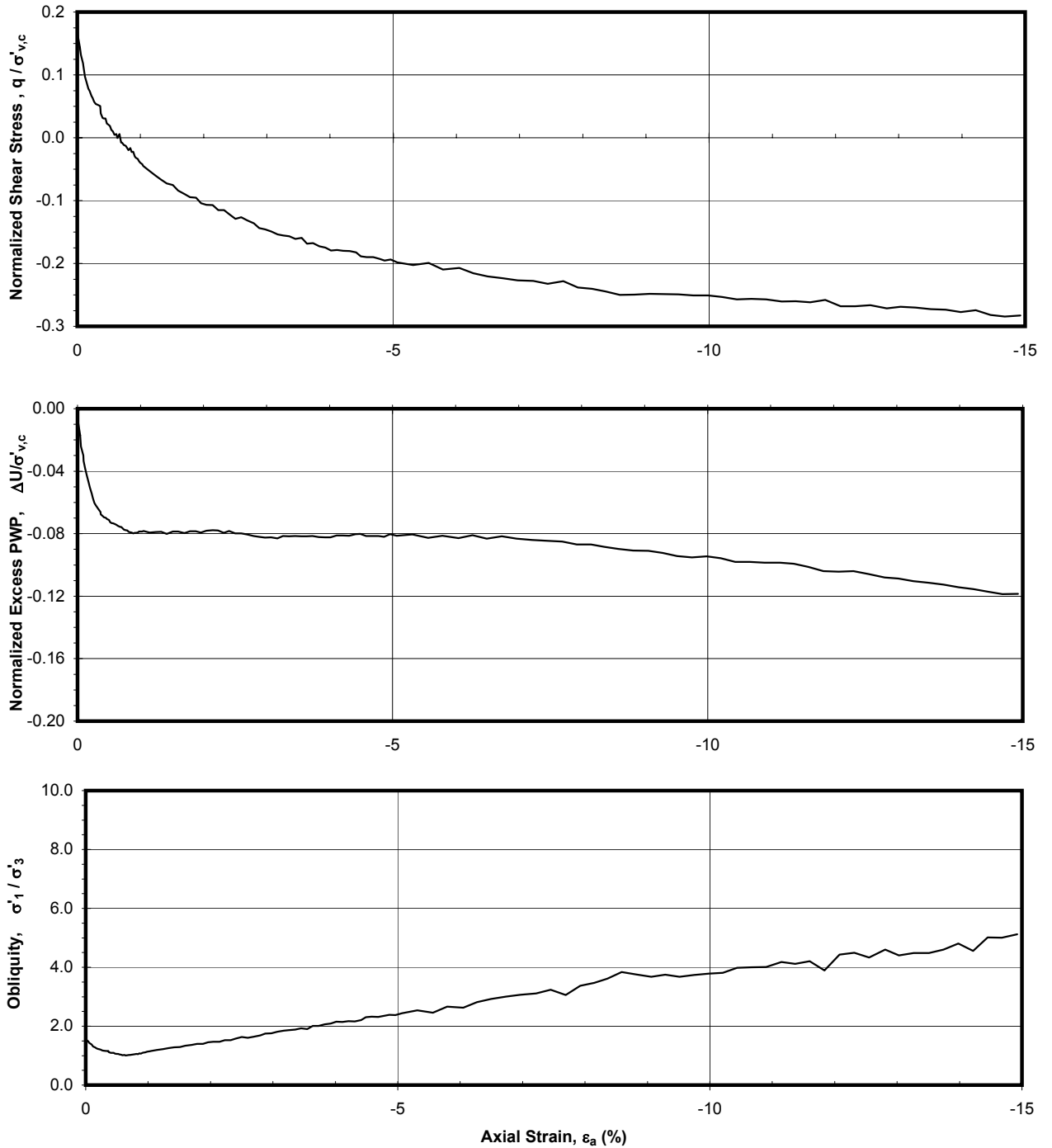

STATIC TRUEPATH TRIAXIAL TEST
 K₀ Consolidated - OCR = 1 - Extension
 Sample: 12a - Depth: 23.59 m
 Boring AT13#2
 Block 13, Atwater Valley Area, Gulf of Mexico

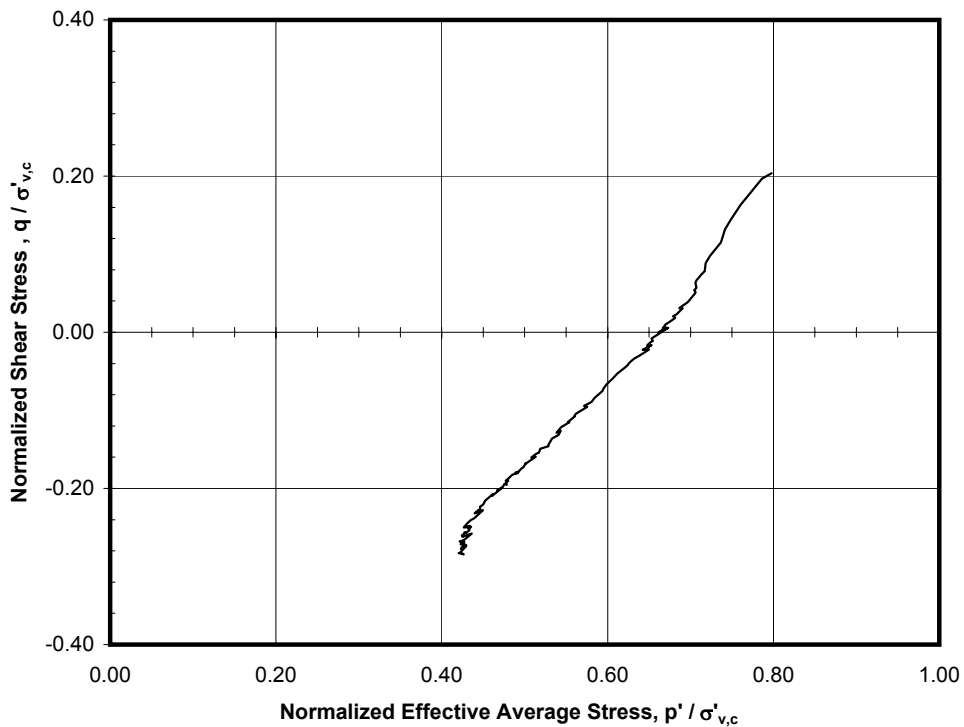
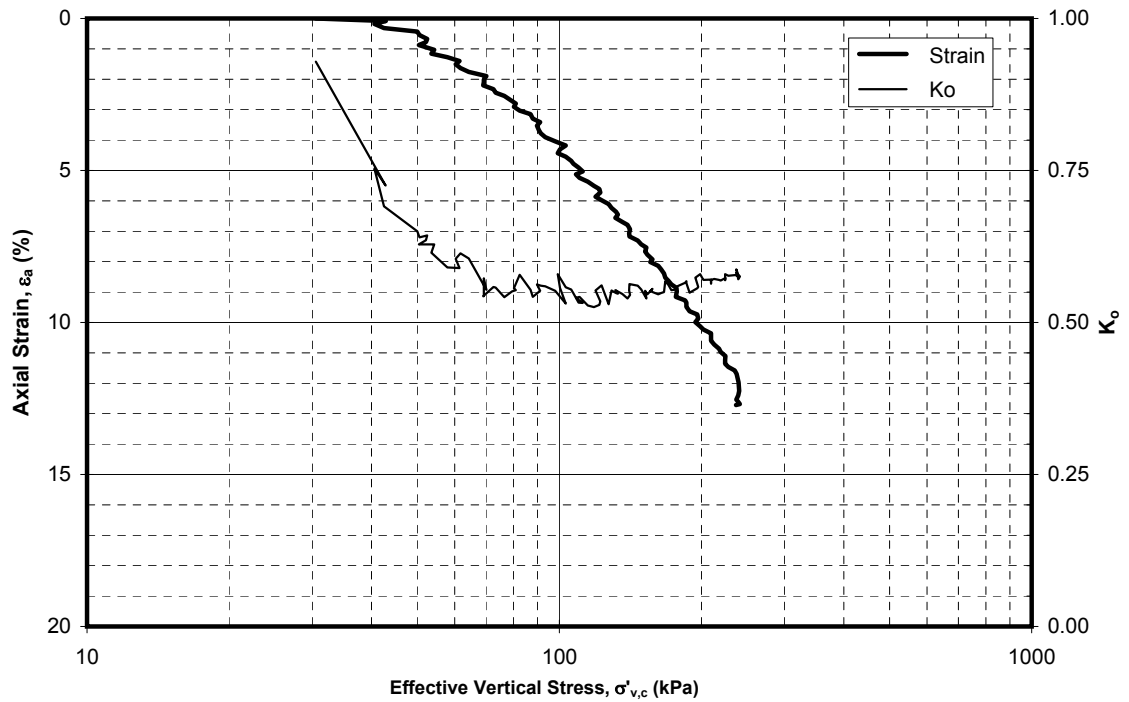

STATIC TRUEPATH TRIAXIAL TEST
 K_o Consolidated - OCR = 1 - Extension
 Sample: 12a - Depth: 23.59 m
 Boring AT13#2
 Block 13, Atwater Valley Area, Gulf of Mexico

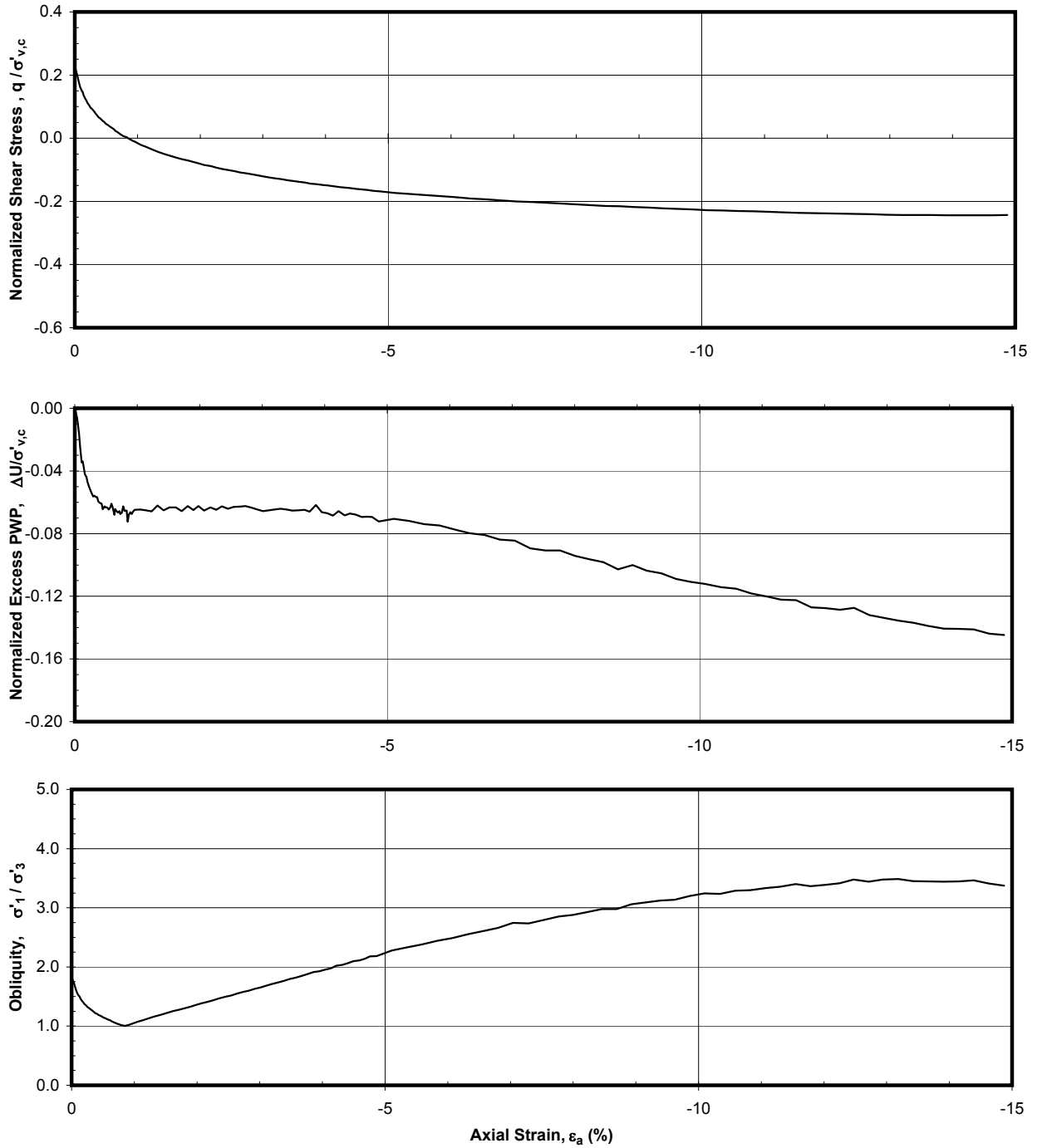

STATIC TRUETHAT TRIAXIAL TEST
 K₀ Consolidated - OCR = 1 - **Extension**
 Sample: 18a - Depth: 41.30 m
 Boring AT13#2
 Block 13, Atwater Valley Area, Gulf of Mexico

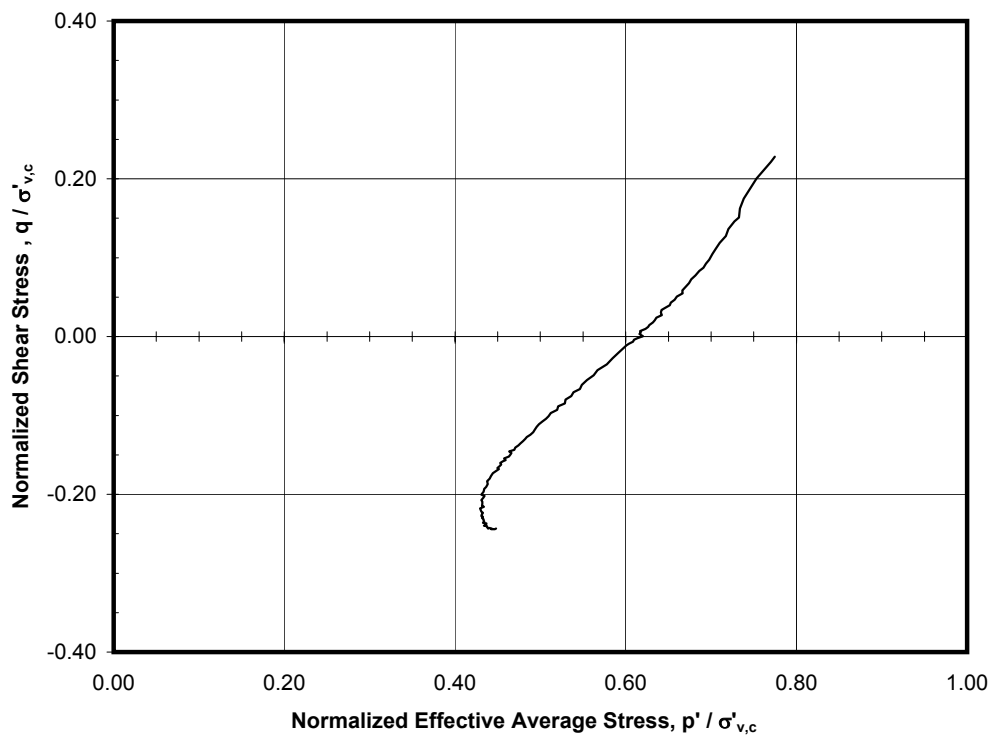
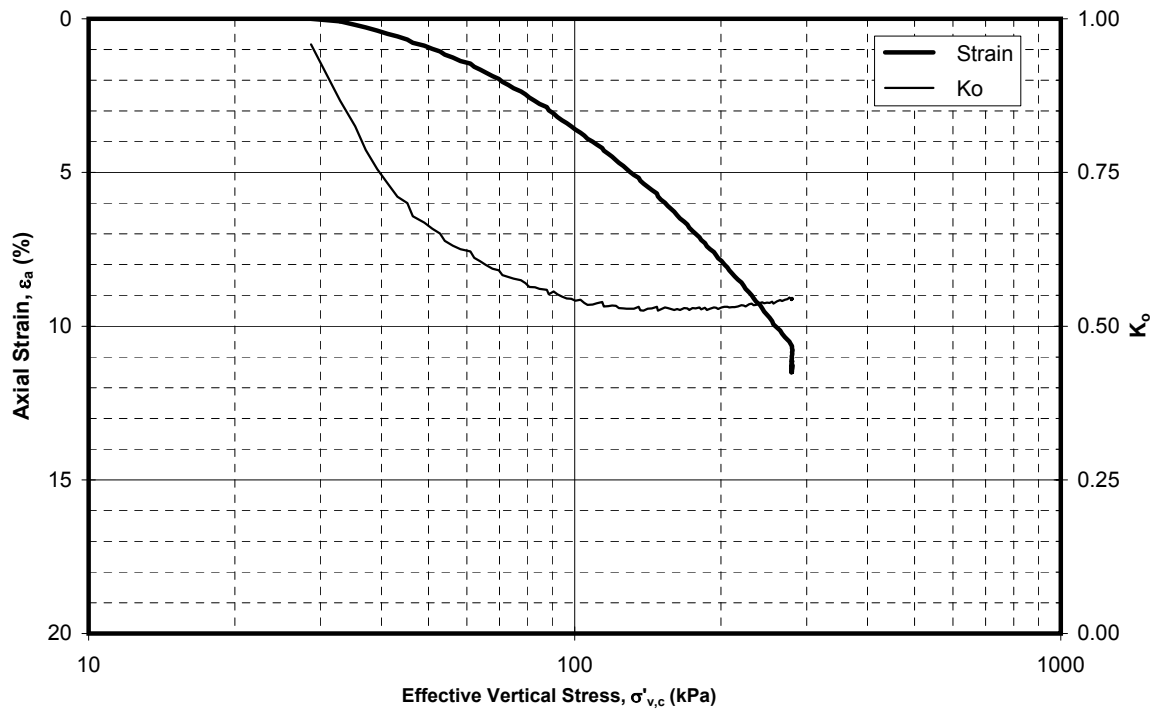

STATIC TRUEPATH TRIAXIAL TEST
 K_o Consolidated - OCR = 1 - Extension
 Sample: 18a - Depth: 41.30 m
 Boring AT13#2
 Block 13, Atwater Valley Area, Gulf of Mexico

Test No.	Specimen Information:			Initial or Consol. Stage	Water Content, w Initial Test (%)	Total Unit Weight, γ_t Initial Test (kN/m ³)	Dry Unit Weight, γ_d Initial Test (kN/m ³)	Void Ratio, e Initial Test	Saturation, S Initial Test (%)	During Consolidation:		During Permeation:		Extrapolated $k_{20^\circ\text{C}}$ (m/y) at initial e in vert. spec.	
	Boring No.	Specimen Orient.	Nominal Diam. (mm)							Isotropic Effective Stress, σ'_c (kPa)	Consol. Time, t_c (days)	Initial Gradient, i_0	Hydraulic Conductivity, $k_{20^\circ\text{C}}$ (m/y)		
1V	Spec. ID	Depth (m)	Vertical Tap Water	64.93	Initial	60.3	16.2	10.1	1.660	99.8				Extrap- $k_{20^\circ\text{C}}$ = 4.34E-02 at e = 1.660	
	5a	8.14			1st	56.2	16.5	10.6	1.547	100.0	28.7	3.08	27.7		2.16E-02
					2nd	52.5	16.8	11.0	1.443	100.0	57.5	2.00	28.1		1.14E-02
1H	Index Properties		Horizontal Tap Water	50.50	Initial	51.6	16.9	11.1	1.417	100.1				Extrap- $k_{20^\circ\text{C}}$ = 2.31E-02 at e = 1.660	
	USCS Symbol	G_s			1st	51.5	16.9	11.2	1.414	100.1	28.7	3.00	26.2		5.78E-03
		2.750			2nd	49.3	17.1	11.4	1.354	100.1	57.5	2.00	26.4		4.12E-03
1R	CH		Remolded	50.43	Initial	49.1	16.9	11.4	1.370	98.7				Extrap- $k_{20^\circ\text{C}}$ = 4.49E-03 at e = 1.660	
	LL	PI	Vertical		1st	47.5	17.2	11.7	1.305	100.0	28.7	3.00	26.4		2.13E-03
	81	56	Tap Water		2nd	44.9	17.5	12.1	1.235	100.0	57.5	5.00	27.0		1.84E-03
2V	Spec. ID	Depth (m)	Vertical Tap Water		Initial									Extrap- $k_{20^\circ\text{C}}$ = at e =	
					1st										
					2nd										
2H	Index Properties		Horizontal Tap Water		Initial									Extrap- $k_{20^\circ\text{C}}$ = at e =	
	USCS Symbol	G_s			1st										
					2nd										
2R	LL	PI	Remolded		Initial									Extrap- $k_{20^\circ\text{C}}$ = at e =	
			Vertical		1st										
			Tap Water		2nd										

Test No.	Description of Tested Soil, Test Remarks, and Supplemental Data:	$C_k = \Delta e / \Delta \log(k)$	C_k / e_0	Extrap. $k_{20^\circ\text{C}}$ Ratios		Plate No.
				H / V	R / V	
1V	Fat clay (CH), olive gray	0.37	0.23	0.53	0.1	B-15
1H	Fat clay (CH), olive gray	0.41	0.25			
1R	Fat clay (CH), olive gray	1.10	0.66			
2V						
2H						
2R						

Note: Indicates value was copied from adjacent test specimen or assumed.

SUMMARY OF HYDRAULIC CONDUCTIVITY (PERMEABILITY) TEST SERIES: VHR

Boring AT13#2

Block 13, Atwater Valley Area, Gulf of Mexico



Date:

Drawn By:

Date:

Date:

Checked By:

Approved By:

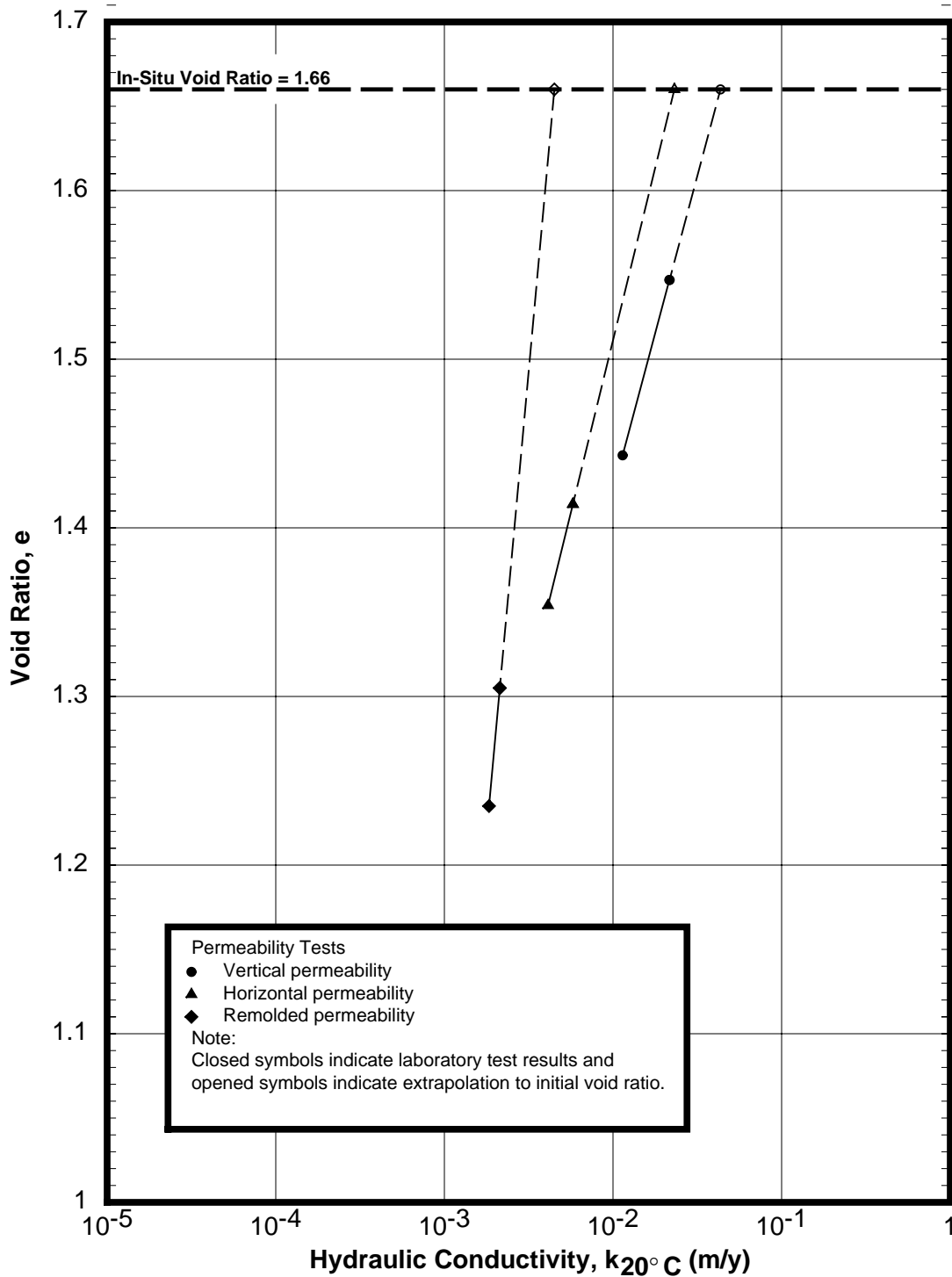

HYDRAULIC CONDUCTIVITY TEST RESULTS: PERMEABILITY AND CRS TESTS
 Boring AT13#2 - Permeability Sample No. 5a - Depth 8.14 m
 CVX Gulf of Mexico Gas Hydrates JIP
 Block 13, Atwater Valley Area, Gulf of Mexico

LABORATORY TESTS			
Classification Tests		Offshore	Onshore
Moisture Content		13	54
Submerged Unit Weight		8	24
Atterberg Limits		35	
Hydrometer Analysis		12	
Specific Gravity		12	
Shear Strength Tests		Offshore	Onshore
Torvane		15	---
Pocket Penetrometer		3	---
Miniature Vane	<i>Undisturbed</i>	16	7
	<i>Remolded</i>	11	9
Unconsolidated-Undrained Triaxial Test	<i>Undisturbed</i>	2	---
	<i>Remolded</i>	---	---
CK₀U'-DSS <i>Static DSS Test</i>	<i>Undisturbed</i>	9	
TPK₀U'-TE <i>True Path™ K₀ Triaxial Extension Test</i>	<i>Undisturbed</i>	2	
1-D Consolidation Tests			
Undisturbed CRS		10	
Hydraulic Conductivity Tests			
Permeability Tests	<i>Vertical</i>	3	
	<i>Horizontal</i>	1	
	<i>Remolded</i>	3	

Note: All tests, except those indicated as "Offshore", were performed at Fugro's Houston laboratory.

SUMMARY OF TYPE AND NUMBER OF TESTS

Boring KC151#3

CVX Gulf of Mexico Gas Hydrates JIP

Block 151, Keathley Canyon Area, Gulf of Mexico

Checked By:
Approved By:

Date:
Date:

Drawn By:

Date:

Summary of Test Results

Job No: 0201-5081-2

10-Jan-2006 (Ver. #3)

Block No: 151

Boring: KC151#3

Area: Keathley Canyon Area

Sample No.	Depth (m)	Identification Tests						Strength Estimate (kPa)		Miniature Vane Tests (kPa)			Compression Tests								
		Liquidity Index	Liquid Limit (%)	Plastic Limit (%)	Moisture Content (%)	Submerged Unit Weight (kN/m ³)	Passing No. 200 Sieve (%)	Penetrometer	Torvane	Undisturbed	Remolded	Residual	Type Test	Moisture Content (%)	Confining Pressure (kPa)	Undisturbed Strength (kPa)	Remolded Strength (kPa)	ε ₅₀ Strain (%)	Submerged Unit Weight (kN/m ³)	Failure Strain (%)	Type of Failure
1	2.65								5	6											
2	2.80	1.03	74	22	75																
2	2.80										8										
2	2.80				83	5.54	99		5	5											
2	2.80										4										
3	5.64								8	12											
4	5.79	.92	87	25	82																
4	5.79										4										
4	5.79										5										
4	5.79				91	5.16			8	16											
6	13.11								7	5											
7	13.26										8										
7	13.26										7										
7	13.26				62	5.74	100		9	4											
7	13.26	.81	53	20	47																
8	15.09	.65	74	23	57				10	18											
9	15.24										11										
9	15.24				70	4.78			11	17											
9	15.24										8										
10	24.75	.55	68	25	49				19												
10	24.75				49	5.81	100		17	28											

Notes:

TYPE OF TEST
 U - Unconfined Compression
 UU- Unconsolidated-Undrained Triaxial
 CU- Consolidated-Undrained Triaxial

TYPE OF FAILURE
 A - Bulge
 B - Single Shear Plane
 C - Multiple Shear Plane
 D - Vertical Fracture

Plus Signs [+] denote tests which exceeded the capacity of the measuring device.

NP = Non Plastic Material



Checked By:
Approved By:

Date:
Date:

Drawn By:

Date:

Summary of Test Results

Job No: 0201-5081-2

10-Jan-2006 (Ver. #3)

Block No: 151

Boring: KC151#3

Area: Keathley Canyon Area

Sample No.	Depth (m)	Identification Tests						Strength Estimate (kPa)		Miniature Vane Tests (kPa)			Compression Tests								
		Liquidity Index	Liquid Limit (%)	Plastic Limit (%)	Moisture Content (%)	Submerged Unit Weight (kN/m ³)	Passing No. 200 Sieve (%)	Penetrometer	Torvane	Undisturbed	Remolded	Residual	Type Test	Moisture Content (%)	Confining Pressure (kPa)	Undisturbed Strength (kPa)	Remolded Strength (kPa)	ε ₅₀ Strain (%)	Submerged Unit Weight (kN/m ³)	Failure Strain (%)	Type of Failure
11	29.69							21	28												
12	29.78										8										
12	29.78										12										
12	29.78	.59	55	20	41																
12	29.78				46	6.31		22				UU		1358	38		0.1	6.31	18	??	
20	42.40				36						29										
20	42.40				37																
20	42.40																				
13	42.82																				
14	42.95				31	7.15	100			46		UU		1661	36		3.5	7.15	20	??	
14	42.95	.33	57	22	33																
14	42.95										18										
21	44.20																				
22	100.83																				
22	100.83				32																
23	210.22						100														
23	210.22				35					37											
23	210.22				36						40										
24	216.62																				
25	224.30				29						45										
25	224.30																				

Notes:

TYPE OF TEST
 U - Unconfined Compression
 UU- Unconsolidated-Undrained Triaxial
 CU- Consolidated-Undrained Triaxial

TYPE OF FAILURE
 A - Bulge
 B - Single Shear Plane
 C - Multiple Shear Plane
 D - Vertical Fracture

Plus Signs [+] denote tests which exceeded the capacity of the measuring device.

NP = Non Plastic Material



Checked By:
Approved By:

Date:
Date:

Drawn By:

Date:

Summary of Test Results

Job No: 0201-5081-2

10-Jan-2006 (Ver. #3)

Block No: 151

Boring: KC151#3

Area: Keathley Canyon Area

Sample No.	Depth (m)	Identification Tests						Strength Estimate (kPa)		Miniature Vane Tests (kPa)			Compression Tests								
		Liquidity Index	Liquid Limit (%)	Plastic Limit (%)	Moisture Content (%)	Submerged Unit Weight (kN/m ³)	Passing No. 200 Sieve (%)	Penetrometer	Torvane	Undisturbed	Remolded	Residual	Type Test	Moisture Content (%)	Confining Pressure (kPa)	Undisturbed Strength (kPa)	Remolded Strength (kPa)	ε ₅₀ Strain (%)	Submerged Unit Weight (kN/m ³)	Failure Strain (%)	Type of Failure
25	224.30				29					58											
26	230.98				29						55										
26	230.98						98														
26	230.98				29					78											
27	243.75																				
28	258.87				37					199+											
28	258.87				36						126										
28	259.02						98														
29	278.62				31					171											
29	278.62				30						142										
29	278.62						100														
30	296.20				34					116											
30	296.20						100														
30	296.20				30						64										
31	313.21						100														
31	313.21				27						137										
31	313.21				28																
15	333.39				30			120	89	159											
15	333.39	.19	61	22	29																
16	350.31				40		99														
16	350.31	.25	83	26	40																

Notes:

TYPE OF TEST
 U - Unconfined Compression
 UU- Unconsolidated-Undrained Triaxial
 CU- Consolidated-Undrained Triaxial

TYPE OF FAILURE
 A - Bulge
 B - Single Shear Plane
 C - Multiple Shear Plane
 D - Vertical Fracture

Plus Signs [+] denote tests which exceeded the capacity of the measuring device.

NP = Non Plastic Material



Checked By:
Approved By:

Date:
Date:

Drawn By:

Date:

Report No. 0201-5081 (Appendix B)

Summary of Test Results

Job No: 0201-5081-2

10-Jan-2006 (Ver. #3)

Block No: 151

Boring: KC151#3

Area: Keathley Canyon Area

Sample No.	Depth (m)	Identification Tests						Strength Estimate (kPa)		Miniature Vane Tests (kPa)			Compression Tests								
		Liquidity Index	Liquid Limit (%)	Plastic Limit (%)	Moisture Content (%)	Submerged Unit Weight (kN/m ³)	Passing No. 200 Sieve (%)	Penetrometer	Torvane	Undisturbed	Remolded	Residual	Type Test	Moisture Content (%)	Confining Pressure (kPa)	Undisturbed Strength (kPa)	Remolded Strength (kPa)	ε ₅₀ Strain (%)	Submerged Unit Weight (kN/m ³)	Failure Strain (%)	Type of Failure
32	370.61				33						116										
32	370.61				36					130											
32	370.61					99															
17	370.91	.10	68	24	29																
17	370.91				34																
18	379.57	.19	48	18	24		132	93													
18	379.57									99											
18	379.57				24		132	101	129												
19	383.26				29	7.49				61											
19	383.26				29																
19	383.26									67											

PLATE B-17d

Notes:

TYPE OF TEST

- U - Unconfined Compression
- UU- Unconsolidated-Undrained Triaxial
- CU- Consolidated-Undrained Triaxial

TYPE OF FAILURE

- A - Bulge
- B - Single Shear Plane
- C - Multiple Shear Plane
- D - Vertical Fracture

Plus Signs [+] denote tests which exceeded the capacity of the measuring device.

NP = Non Plastic Material



Sample Number	Depth		Specific Gravity
	[mbsf]	[ft BML]	
2 1H-3	2.80	9.2	2.782
7 2H-4	13.26	43.5	2.735
10 3H-7	24.75	81.2	2.759
20 5H-6	42.40	139.1	2.755
14 5H-6	42.95	140.9	2.772
22 6C-1	100.82	330.8	2.735
23 7C-1	210.22	689.7	2.756
25 10C-2	224.30	735.9	2.750
29 19H-4	278.82	914.1	2.719
31 21H-2	313.21	1,027.6	2.756
16 23C (shoe)	350.31	1,149.3	2.772
32 24C-2	370.61	1,215.9	2.788

ADDITIONAL CLASSIFICATION TEST RESULTS

Boring KC151#3

Specific Gravity Test Results

CVX Gulf of Mexico Gas Hydrates JIP

Block 151, Keathley Canyon Area, Gulf of Mexico

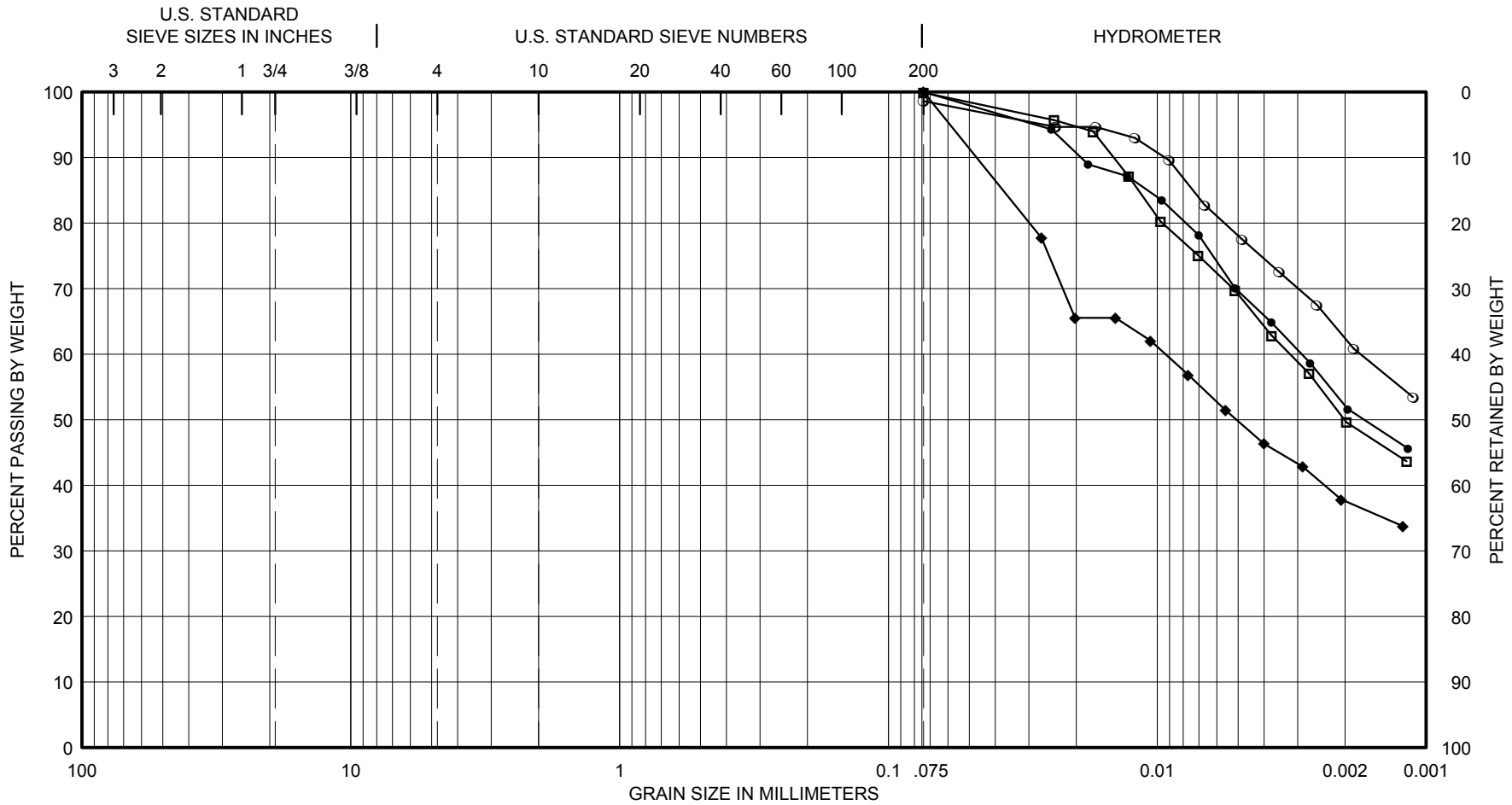

GRAVEL		SAND			SILT or CLAY
Coarse	Fine	Coarse	Medium	Fine	

SAMPLE NO.	DEPTH, M	SYMBOL	CLASSIFICATION
2	2.80	○	Fat Clay (CH), olive gray with brown
7	13.26	□	Fat Clay (CH), olive gray
10	24.75	◆	Fat Clay (CH), olive gray
14	42.95	●	Fat Clay (CH), olive gray

GRAIN-SIZE DISTRIBUTION CURVES
 Boring KC151#3
 CVX Gulf of Mexico Gas Hydrates JIP
 Block 151, Keathley Canyon Area, Gulf of Mexico



Checked by:

Date:

Drawn by:

Date:

Approved by:

Date:

Report No. U201-5081 (Appendix B)

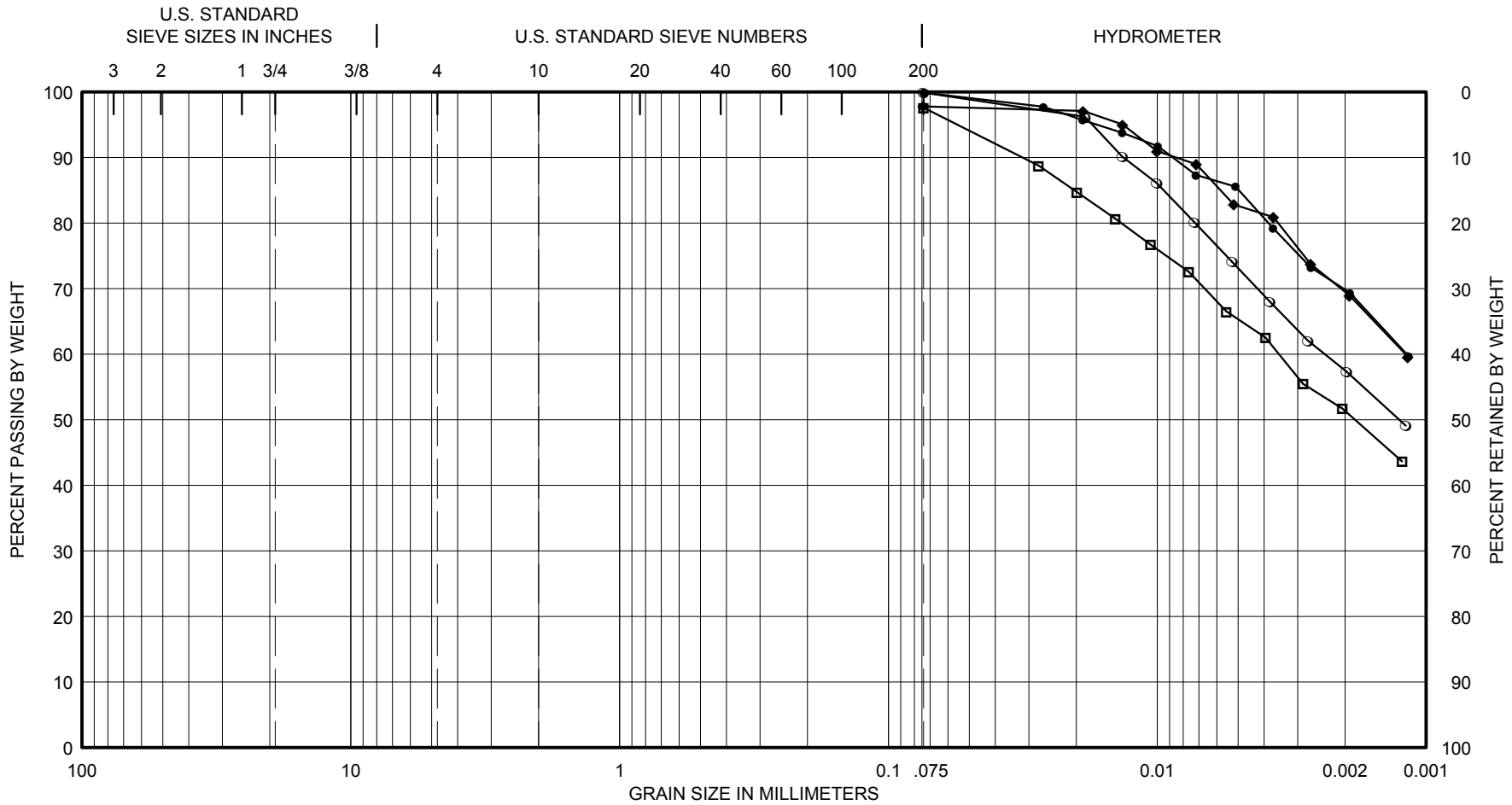

GRAVEL		SAND			SILT or CLAY
Coarse	Fine	Coarse	Medium	Fine	

SAMPLE NO.	DEPTH, M	SYMBOL	CLASSIFICATION
23	210.22	○	Fat Clay (CH), olive gray w/ a few shell fragments
26	230.98	□	Fat Clay (CH), olive gray
28	258.87	◆	Fat Clay (CH), olive gray w/ a few shell fragments
29	278.62	●	Fat Clay (CH), olive gray w/ shell fragments

GRAIN-SIZE DISTRIBUTION CURVES
 Boring KC151#3
 CVX Gulf of Mexico Gas Hydrates JIP
 Block 151, Keathley Canyon Area, Gulf of Mexico

PLATE B-190



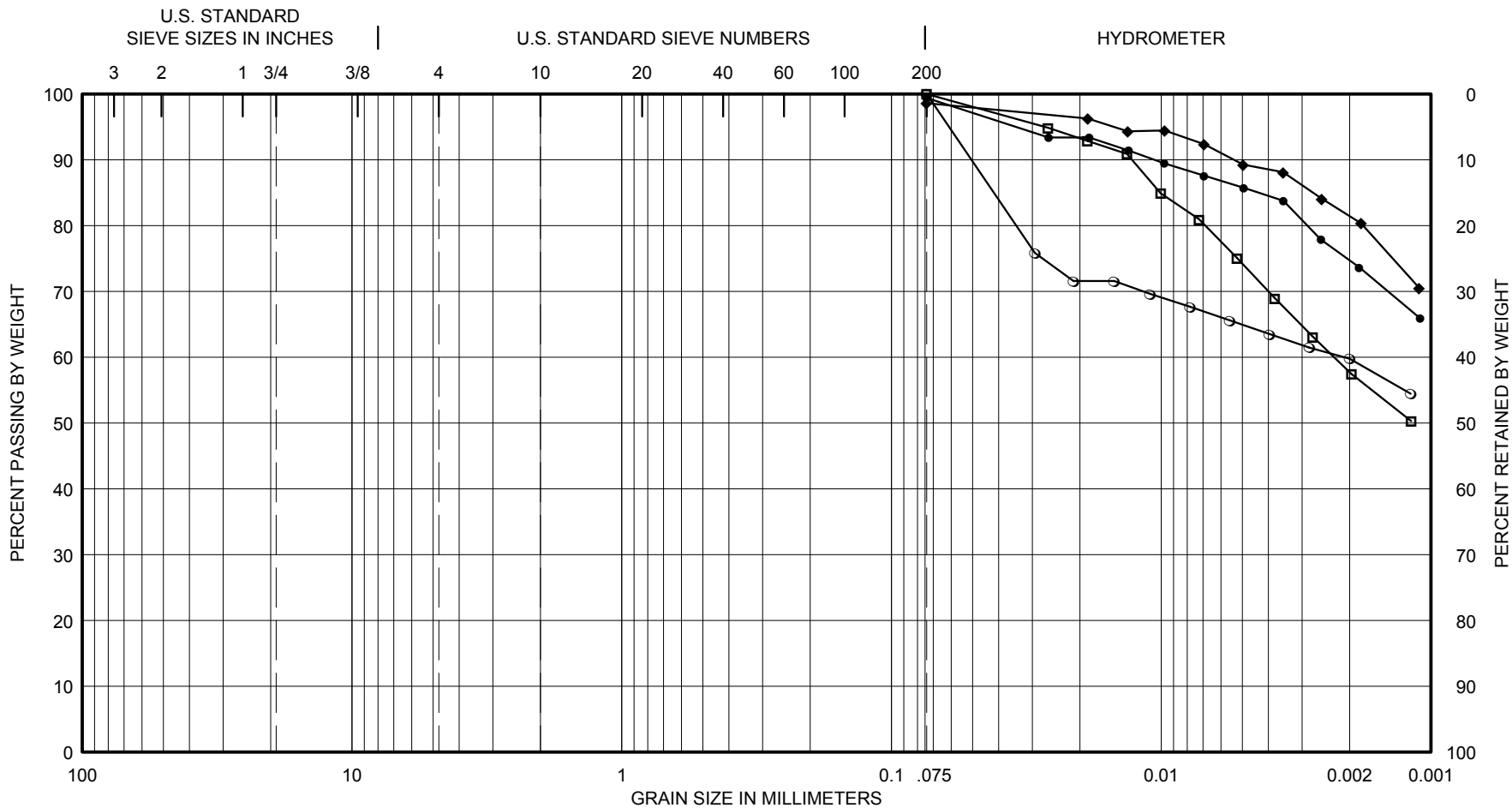

GRAVEL		SAND			SILT or CLAY
Coarse	Fine	Coarse	Medium	Fine	

SAMPLE NO.	DEPTH, M	SYMBOL	CLASSIFICATION
30	296.20	○	Fat Clay (CH), olive gray w/ a few shell fragments
31	313.21	□	Fat Clay (CH), olive gray w/ silt seams
16	350.31	◆	Fat Clay (CH), olive gray w/ silt pockets and a few shell fragments
32	370.61	●	Fat Clay (CH), olive gray w/ a few silt pockets

GRAIN-SIZE DISTRIBUTION CURVES
 Boring KC151#3
 CVX Gulf of Mexico Gas Hydrates JIP
 Block 151, Keathley Canyon Area, Gulf of Mexico



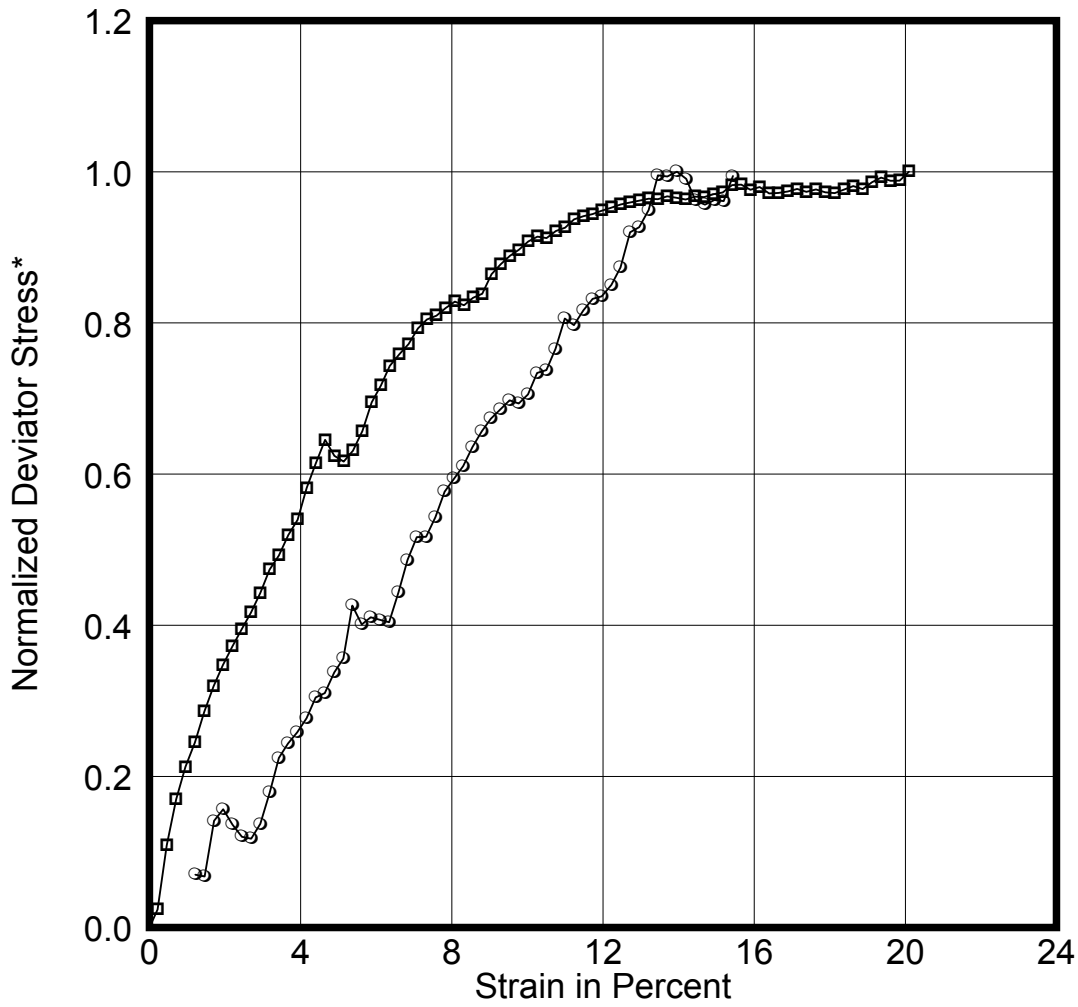

Curve	Sample No.	Depth [m]	Test Type	Confining Pressure [kPa]	Maximum Deviator Stress [kPa]	ϵ_{50} [%]
○—○	12	29.57	UU	1358	29	6.9
□—□	14	42.95	UU	1661	73	3.5

* Normalized with respect to maximum deviator stress.

STRESS-STRAIN CURVES
Unconsolidated-Undrained Triaxial Compression Test

Boring KC151#3
CVX Gulf of Mexico Gas Hydrates JIP
Block 151, Keathley Canyon Area, Gulf of Mexico

Date:

Drawn By:

Date:

Date:

Checked By:

Approved By:

Series &/or Test No.	Sample - Spec. No.	Penetration or Depth (m)	Index Properties:					At Preconsol. Stress: Casagrande Method		Compression Ratios:			Coeff. of Consol., c_v Virgin Loading (m^2/y)	Remarks: SB-Sharp Break RSB-Relatively SB MR-Mod. Rounded R-Rounded
			G_s	S_o (%)	LL PI	W_o (%) L_{10}	$\gamma_{t,o}$ (kN/m^3) e_o	Becker Method ⁽¹⁾		Virgin CR CR by LL (CR_{LL}) ⁽²⁾	Recomp. RR Swell (SR)	Ratio of CR/CR _{LL} CR/RR		
								σ'_p (kPa)	ϵ_a (%)					
1	20a (5H-6)	42.40	2.750	98.4	52	38.8	17.9	362.5	7.8	0.146	0.027	0.80	2.10 - 2.90	MR-Mod. Rounded
					32	0.588	1.083	366.8		0.181	0.023	5.41		
2	21a (5H-7)	44.16	2.750	93.5	51	33.1	18.2	105.8	3.9	0.109	0.018	0.58	1.79 - 3.22	MR-Mod. Rounded
					34	0.474	0.974	141.2		0.187	0.016	6.06		
3	22b (6C-1)	100.83	2.750	98.9	50	33.7	18.6	364.8	7.1	0.119	0.020	0.64	100.3 - 298.5	MR-Mod. Rounded
					34	0.521	0.937	363.9		0.186	0.015	5.95		
4	23a (7C-1)	210.17	2.750	96.5	71	40.5	17.6	628.2	10.0	0.140	0.035	0.52	0.73 - 1.23	MR-Mod. Rounded
					51	0.402	1.045	582.7		0.268	0.032	4.00		
5	25a (10C-2)	224.30	2.750	97.6	50	31.4	18.8	298.3	6.5	0.115	0.017	0.60	1.60 - 2.37	MR-Mod. Rounded
					33	0.436	0.885	477.8		0.191	0.014	6.76		
6	26a (12C-1)	230.98	2.750	100.0	49	29.9	19.2	479.8	7.4	0.124	0.023	0.64	1.39 - 2.14	MR-Mod. Rounded
					32	0.403	0.822	965.7		0.193	0.017	5.39		
7	27a (14C-2)	243.70	2.750	103.2	49	34.0	18.9	198.2	7.4	0.119	0.019	0.65	2.43 - 3.00	MR-Mod. Rounded
					33	0.545	0.907	399.8		0.184	0.018	6.26		
8	29a (19H-4)	278.62	2.750	88.8	80	33.3	17.7	905.9	8.3	0.161	0.048	0.52	0.42 - 0.73	RSB-Relatively SB
					57	0.181	1.032	947.6		0.310	0.043	3.35		
9	31a (21H-2)	313.21	2.750	93.1	66	30.9	18.4	1220.0	7.4	0.151	0.038	0.57	0.62 - 1.10	RSB-Relatively SB
					45	0.220	0.912	1298.5		0.264	0.035	3.97		
10	32a (24C-2)	370.51	2.750	100.8	88	43.9	17.6	1187.9	9.6	0.217	0.049	0.68	0.49 - 0.87	RSB-Relatively SB
					64	0.311	1.198	1753.9		0.319	0.058	4.43		

No.	Description of Tested Soil, Test Remarks, and Supplemental Data:	Plate Number
1	Clay, olive gray	B-22
2	Clay, olive gray	B-23
3	Silty clay, olive gray silt seams	B-24
4	Clay, olive gray with many organic streaks and silt pockets	B-25
5	Clay, olive gray	B-26
6	Clay, olive gray with a few organic traces	B-27
7	Clay, olive gray with organic streaks	B-28
8	Clay, dark gray with a few silt pockets	B-29
9	Clay, olive gray with silt seams	B-30
10	Clay, dark gray and very blocky	B-31

Notes: Indicates value was copied from adjacent test specimen or assumed.

⁽¹⁾ Estimated preconsolidation stress using the Work per Unit Volume method, as described by Becker, et al. (1987).

⁽²⁾ $CR_{LL} = ((LL - 10) \times 0.009) / (1 + e_o)$

SUMMARY OF 1-D CONSOLIDATION TESTS: VERSUS DEPTH

Boring KC151#3

Block 151, Keathley Canyon Area, Gulf of Mexico

Date:

Drawn By:

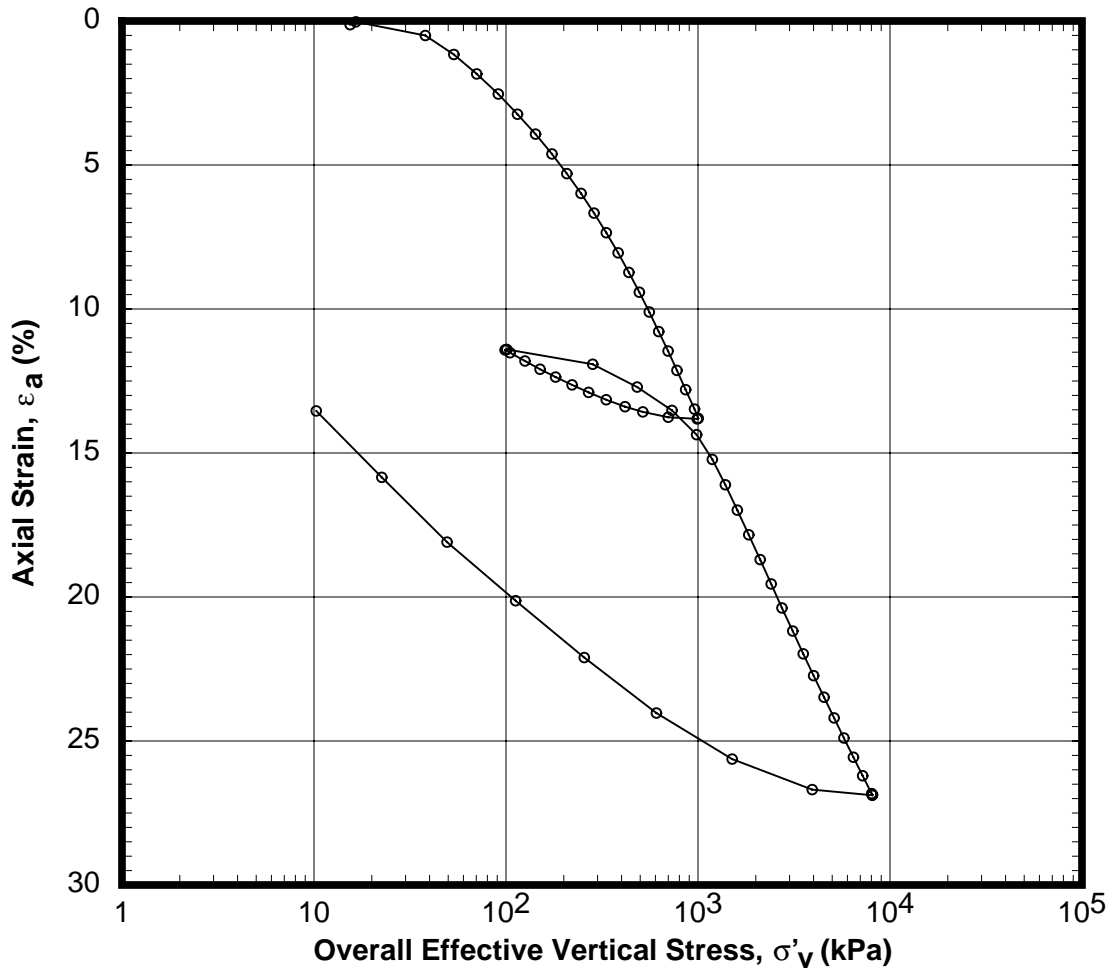

□ - Loading with solid symbols indicating reloading increments.
 ○ - Unloading (Final)

Date:

Date:

Checked By:

Approved By:

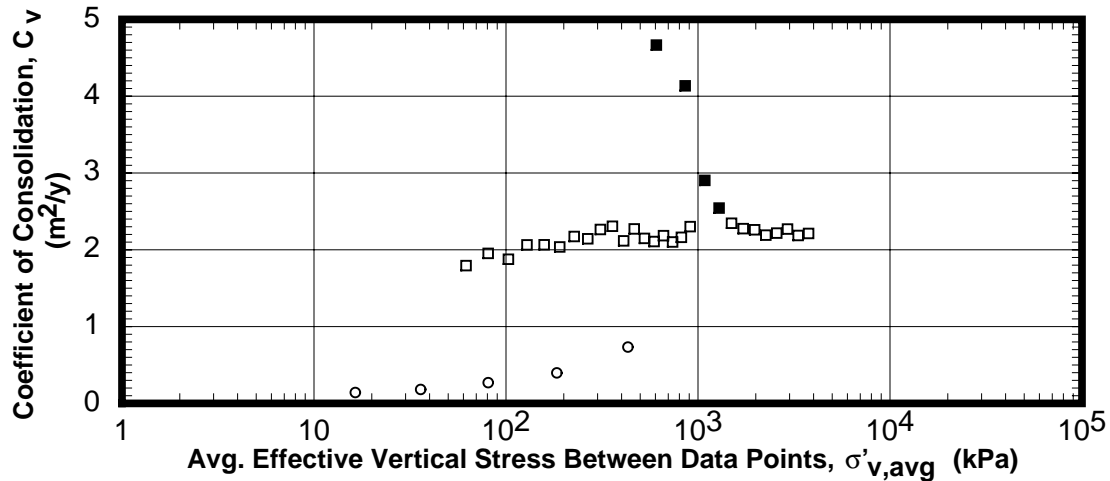

1-D CONSOLIDATION TEST: CRS
 Boring KC151#3 - Sample No. 20(5H-6)a - Depth 42.40 m
 CVX Gulf of Mexico Gas Hydrates JIP
 Block 151, Keathley Canyon Area, Gulf of Mexico

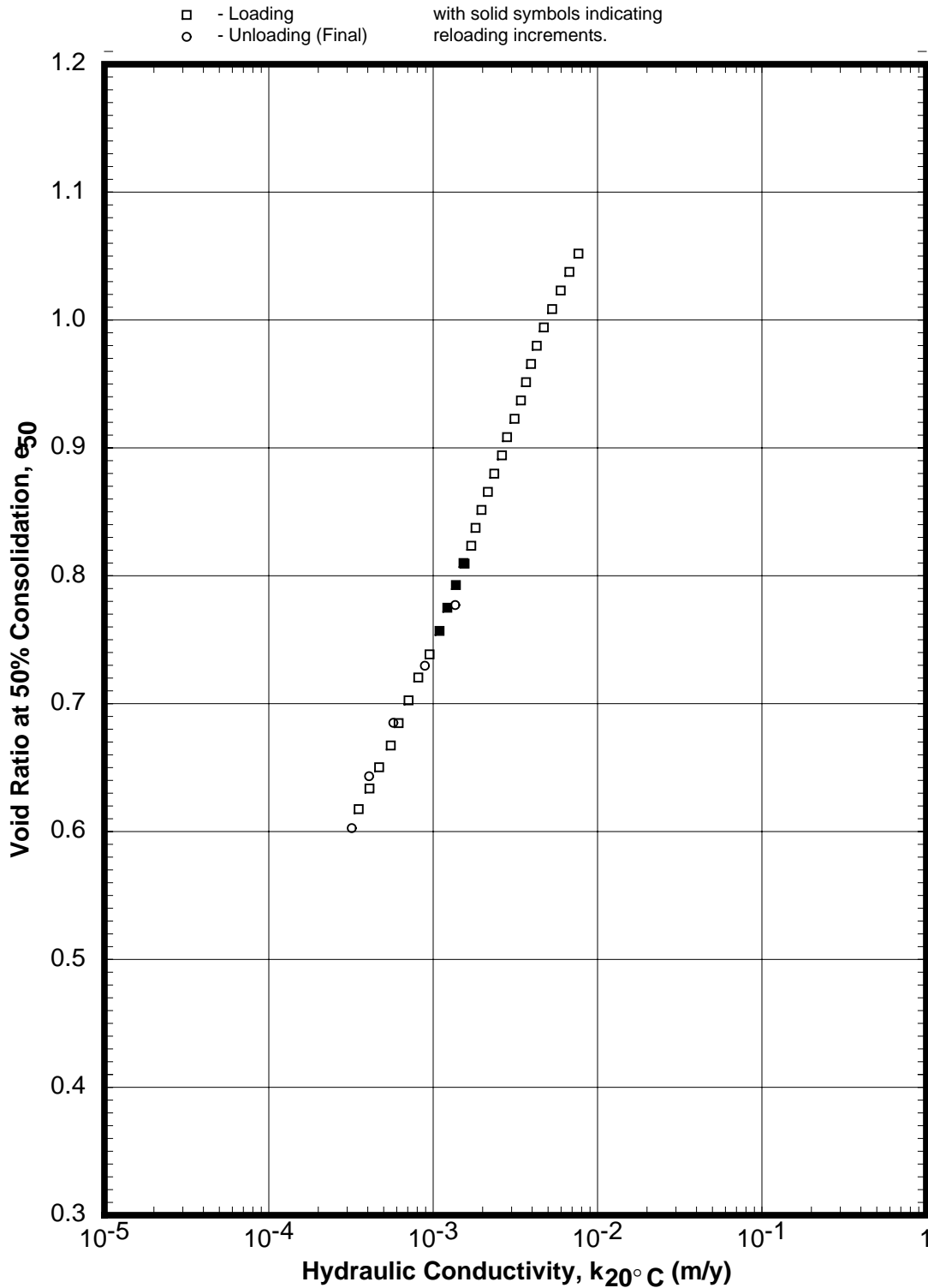

1-D CONSOLIDATION TEST: CRS
 Boring KC151#3 - Sample No. 20(5H-6)a - Depth 42.40 m
 CVX Gulf of Mexico Gas Hydrates JIP
 Block 151, Keathley Canyon Area, Gulf of Mexico

Date:

Drawn By:

Date:

Date:

Checked By:

Approved By:

Date:

Drawn By:

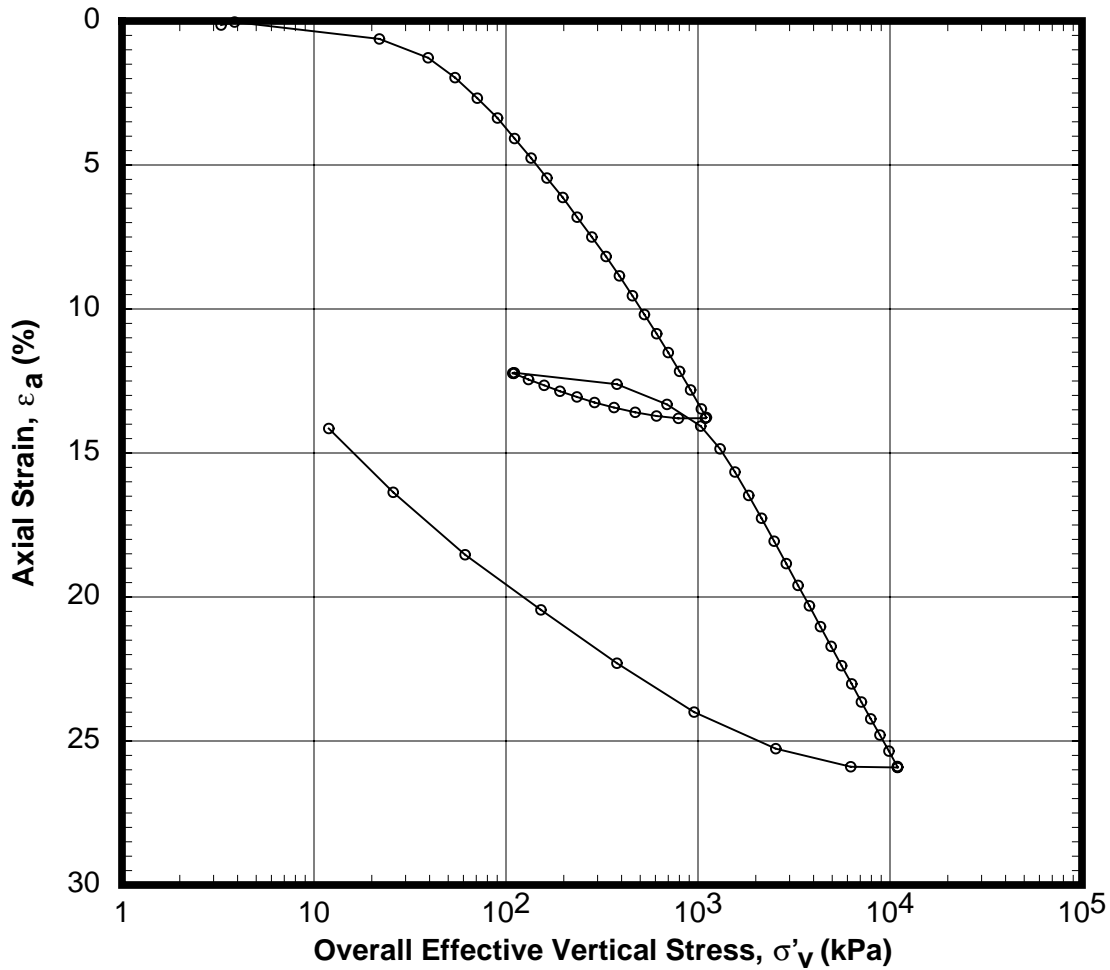

□ - Loading with solid symbols indicating
 ○ - Unloading (Final) reloading increments.

Date:

Date:

Checked By:

Approved By:

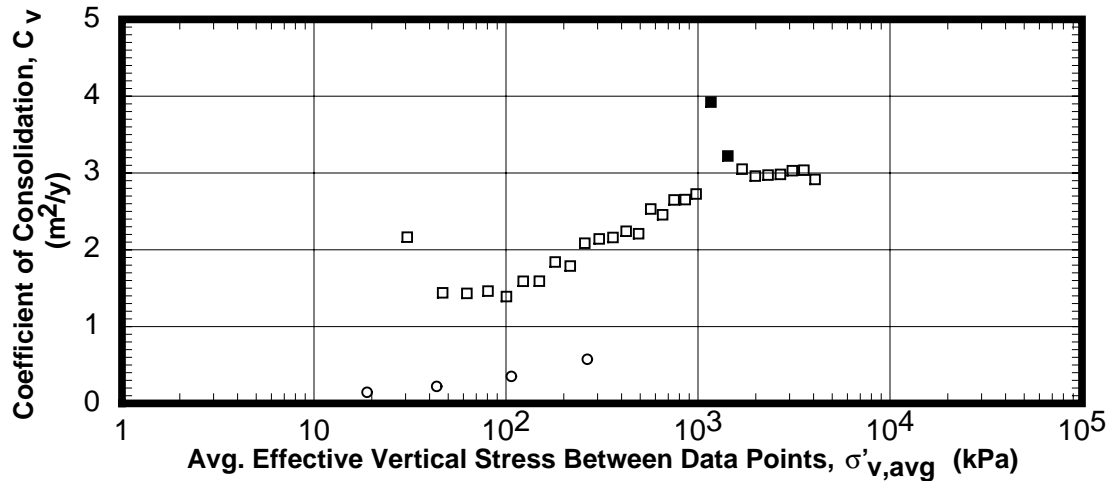

1-D CONSOLIDATION TEST: CRS
 Boring KC151#3 - Sample No. 21(5H-7)a - Depth 44.16 m
 CVX Gulf of Mexico Gas Hydrates JIP
 Block 151, Keathley Canyon Area, Gulf of Mexico

Date:

Drawn By:

Date:

Date:

Checked By:

Approved By:

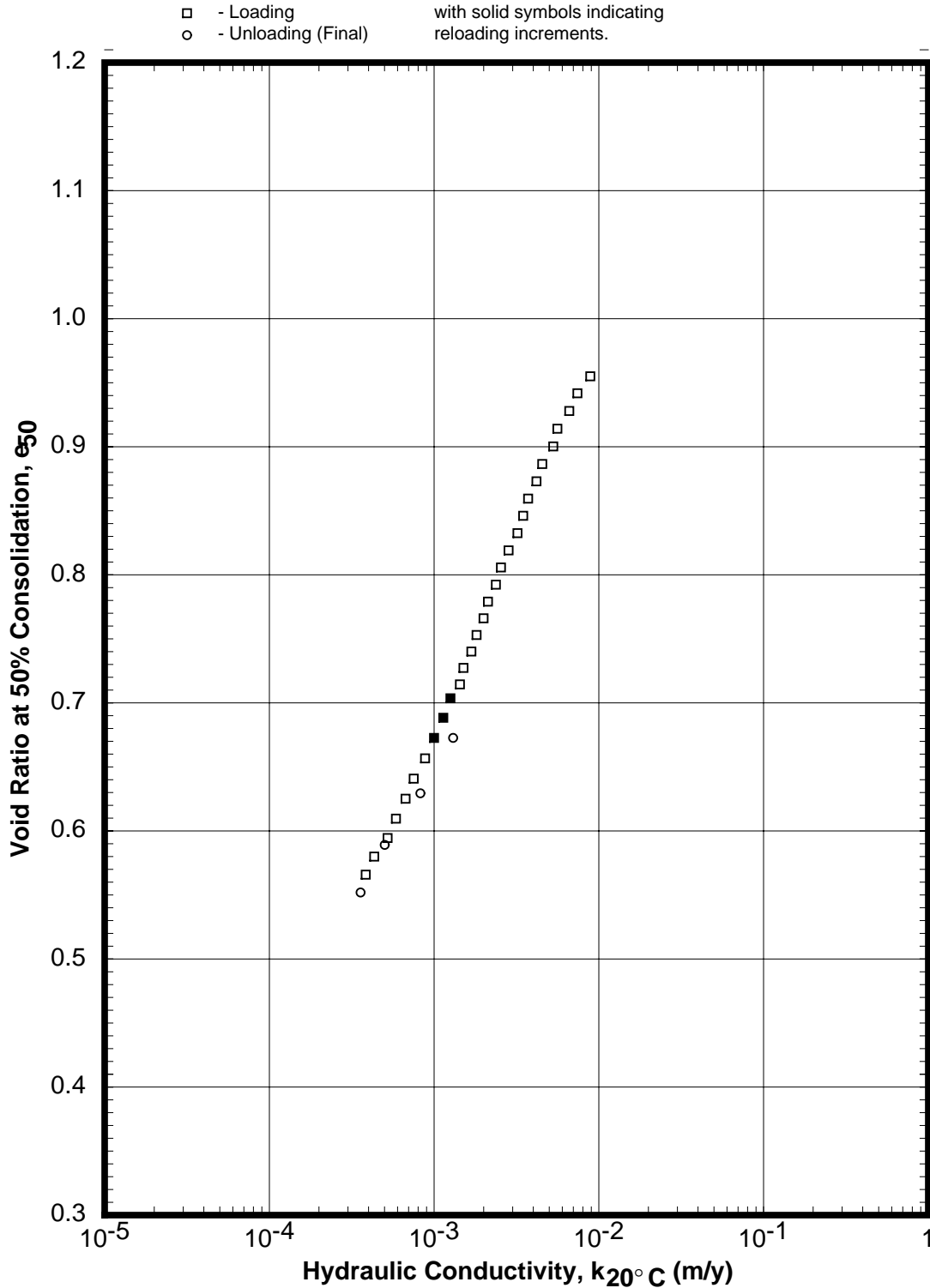

1-D CONSOLIDATION TEST: CRS
 Boring KC151#3 - Sample No. 21(5H-7)a - Depth 44.16 m
 CVX Gulf of Mexico Gas Hydrates JIP
 Block 151, Keathley Canyon Area, Gulf of Mexico

Date:

Drawn By:

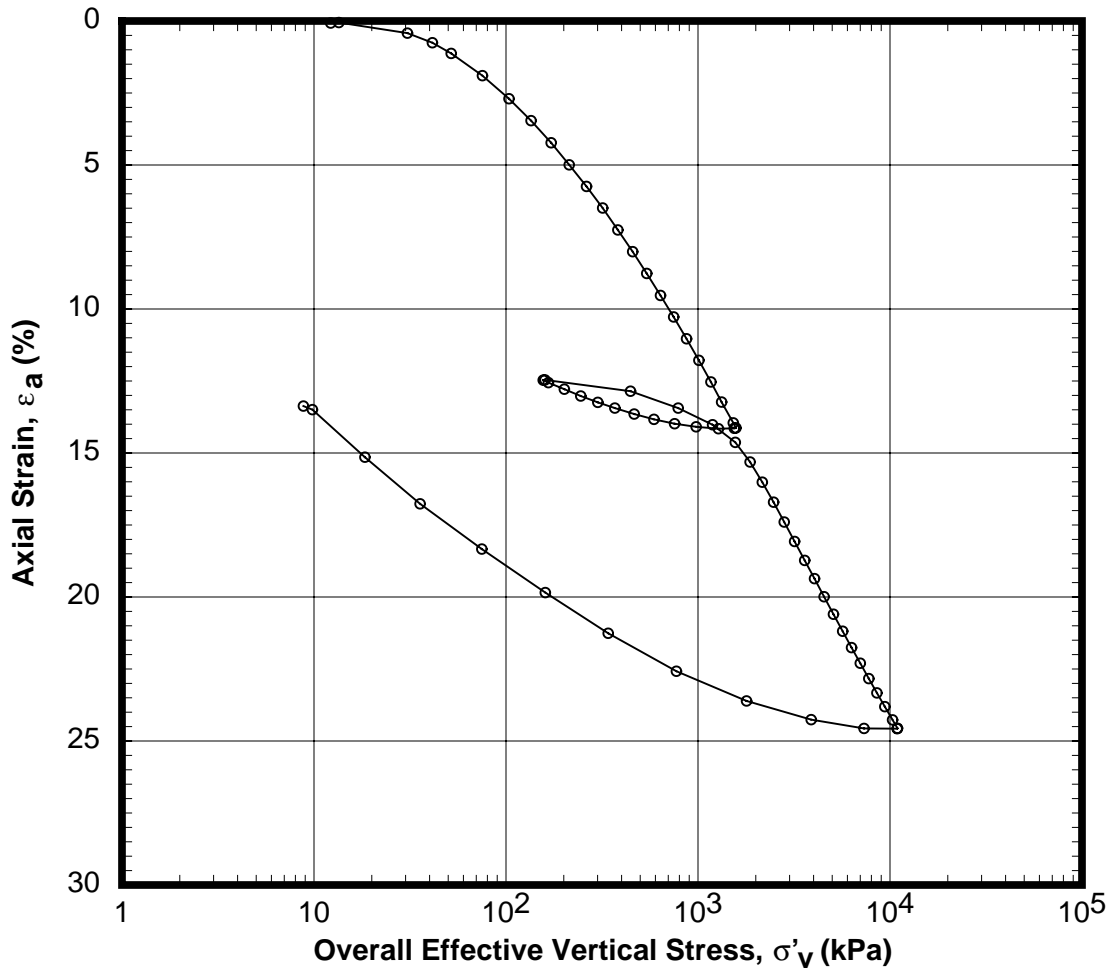

□ - Loading with solid symbols indicating
 ○ - Unloading (Final) reloading increments.

Date:

Date:

Checked By:

Approved By:

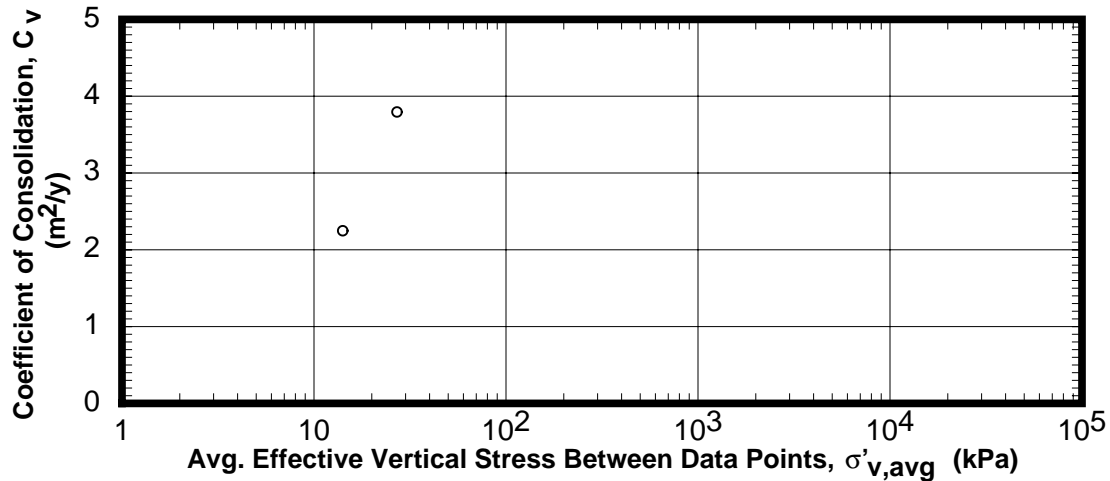

1-D CONSOLIDATION TEST: CRS
 Boring KC151#3 - Sample No. 22(6C-1)b - Depth 100.83 m
 CVX Gulf of Mexico Gas Hydrates JIP
 Block 151, Keathley Canyon Area, Gulf of Mexico

Date:

Drawn By:

Date:

Date:

Checked By:

Approved By:

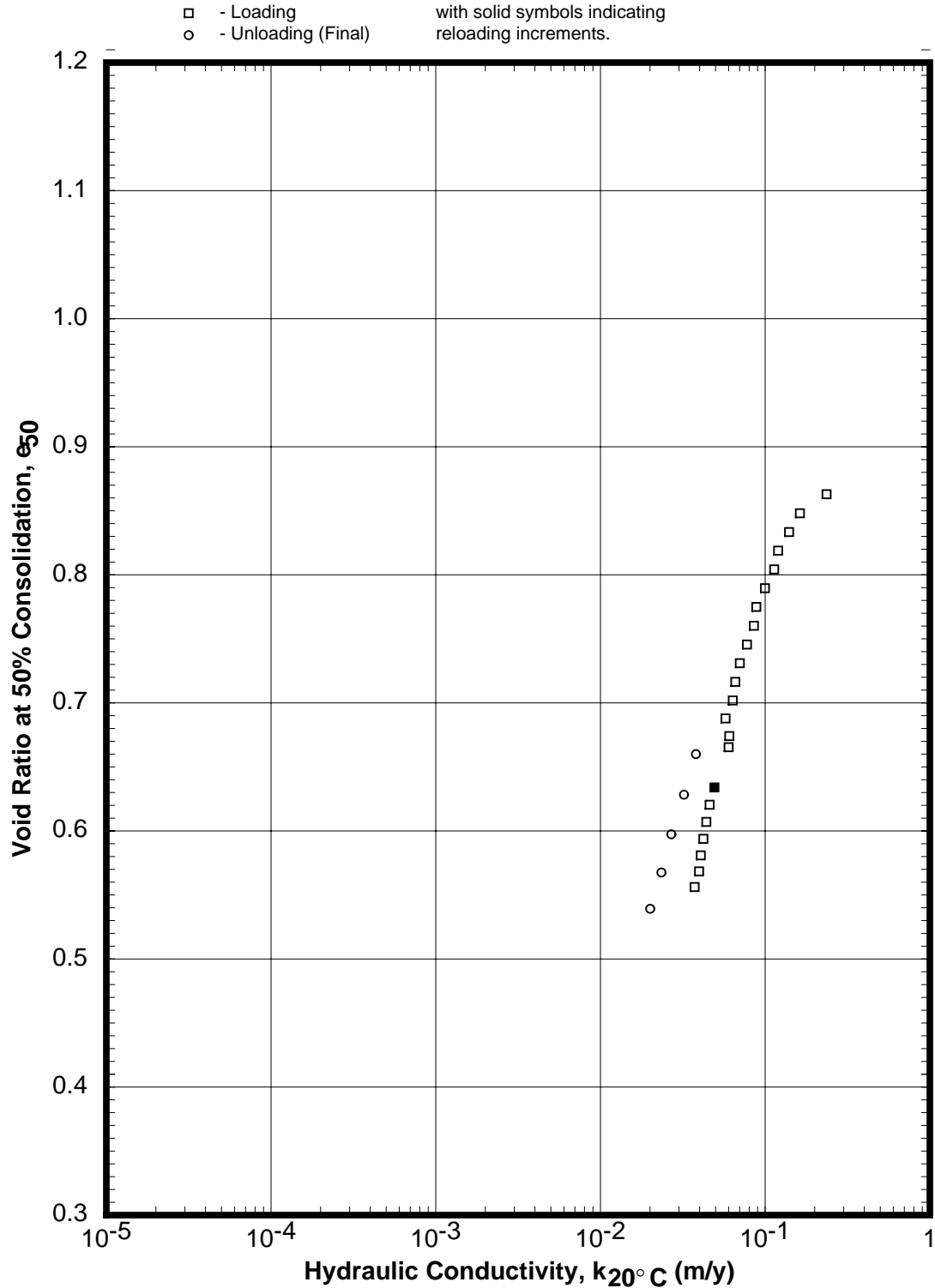

1-D CONSOLIDATION TEST: CRS
 Boring KC151#3 - Sample No. 22(6C-1)b - Depth 100.83 m
 CVX Gulf of Mexico Gas Hydrates JIP
 Block 151, Keathley Canyon Area, Gulf of Mexico

Date:

Drawn By:

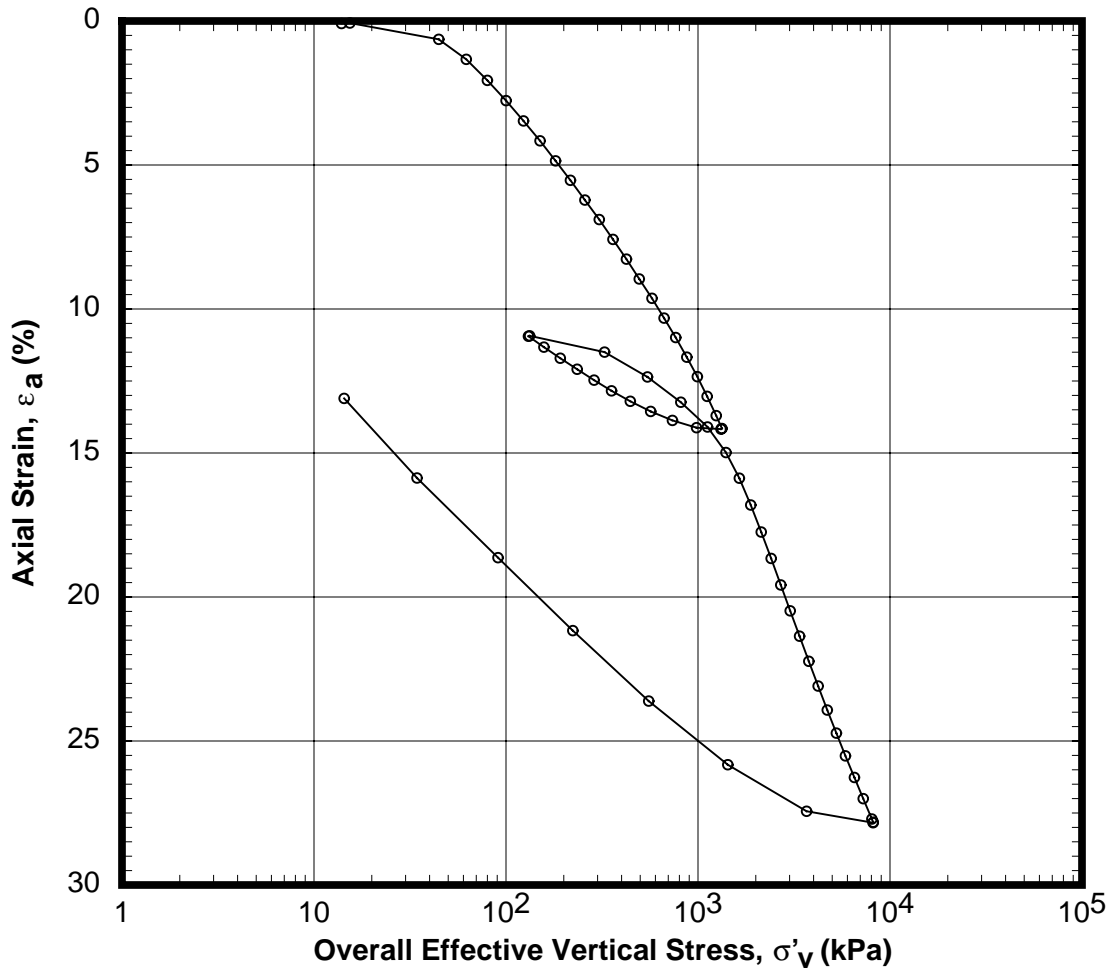

□ - Loading with solid symbols indicating
 ○ - Unloading (Final) reloading increments.

Date:

Date:

Checked By:

Approved By:

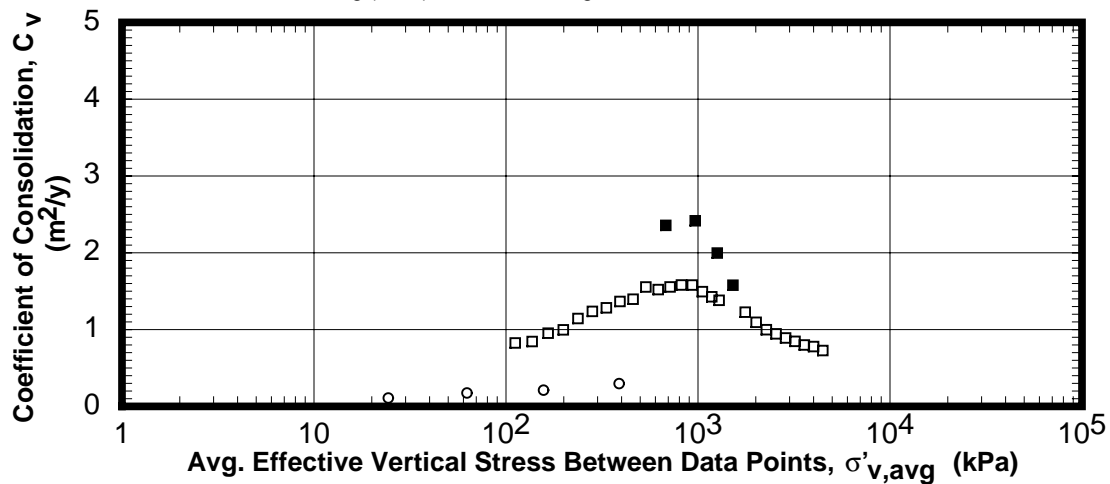

1-D CONSOLIDATION TEST: CRS
 Boring KC151#3 - Sample No. 23(7C-1)a - Depth 210.17 m
 CVX Gulf of Mexico Gas Hydrates JIP
 Block 151, Keathley Canyon Area, Gulf of Mexico

Date:

Drawn By:

Date:

Date:

Checked By:

Approved By:

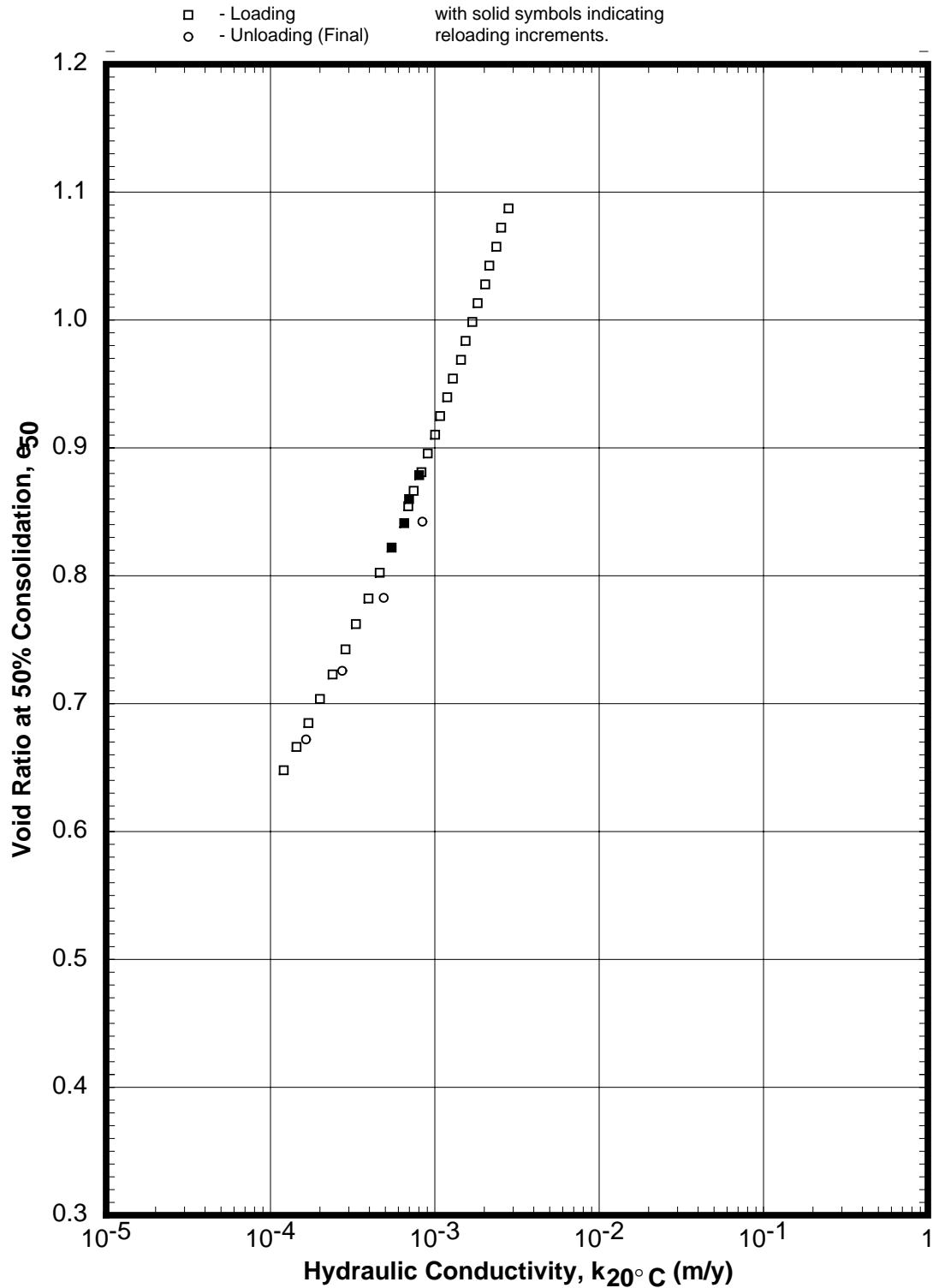

1-D CONSOLIDATION TEST: CRS
 Boring KC151#3 - Sample No. 23(7C-1)a - Depth 210.17 m
 CVX Gulf of Mexico Gas Hydrates JIP
 Block 151, Keathley Canyon Area, Gulf of Mexico

Date:

Drawn By:

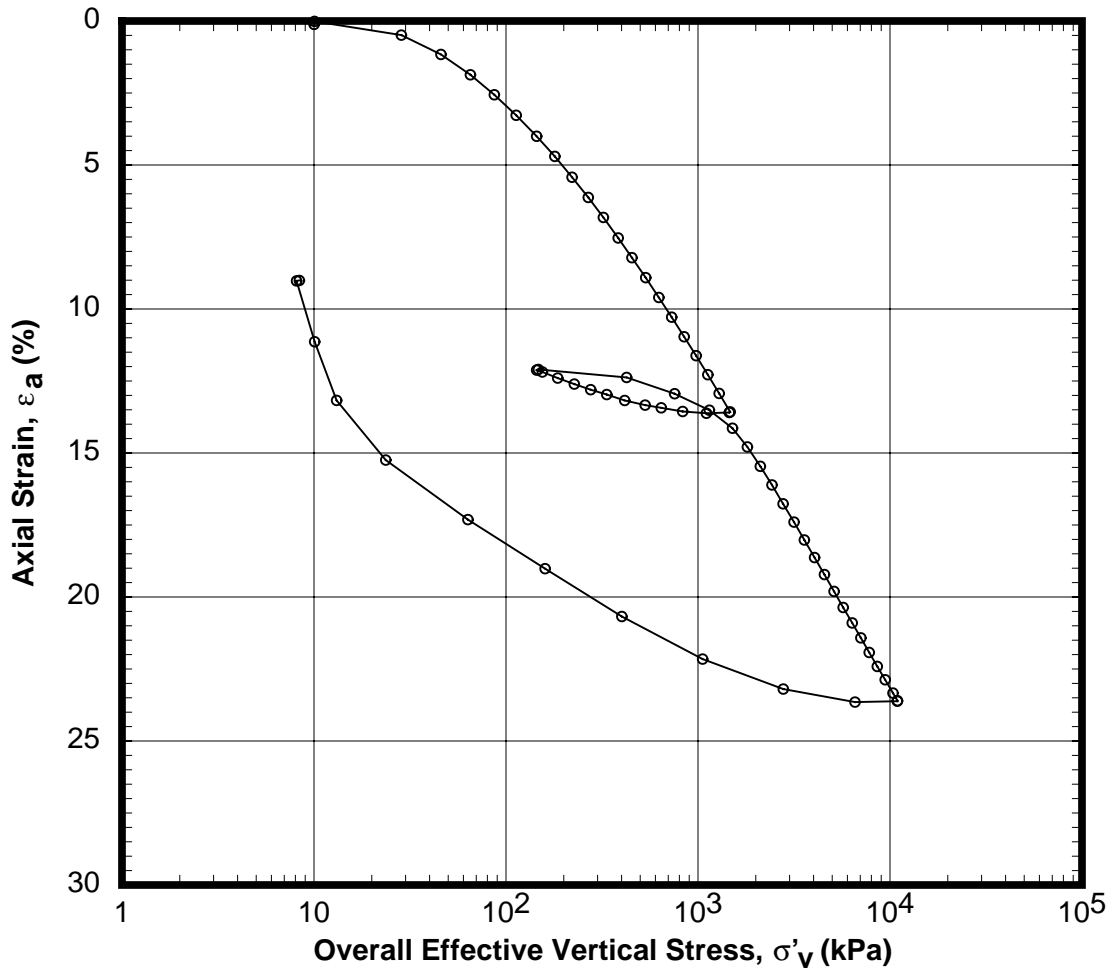

□ - Loading with solid symbols indicating
 ○ - Unloading (Final) reloading increments.

Date:

Date:

Checked By:

Approved By:

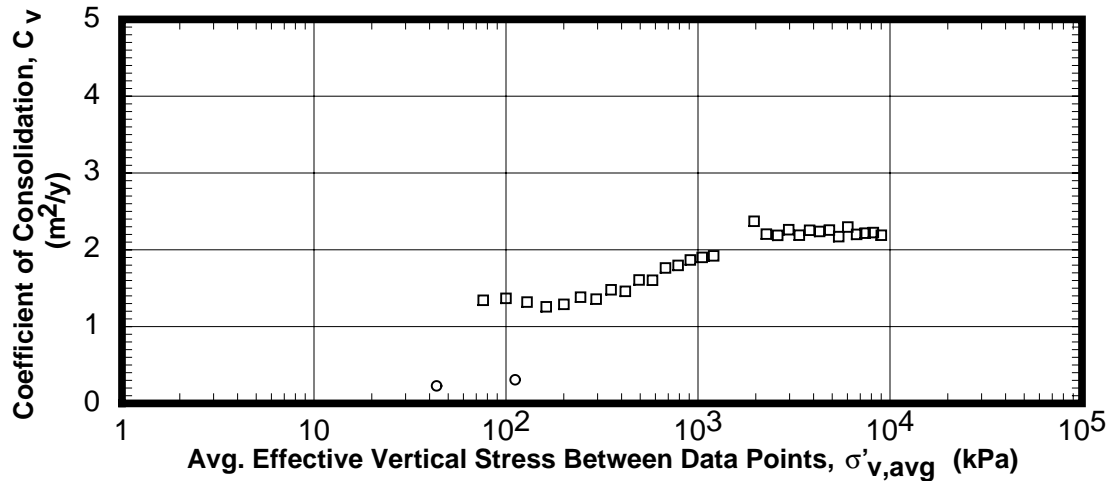

1-D CONSOLIDATION TEST: CRS
 Boring KC151#3 - Sample No. 25(10C-2)a - Depth 224.30 m
 CVX Gulf of Mexico Gas Hydrates JIP
 Block 151, Keathley Canyon Area, Gulf of Mexico

Date:

Drawn By:

Date:

Date:

Checked By:

Approved By:

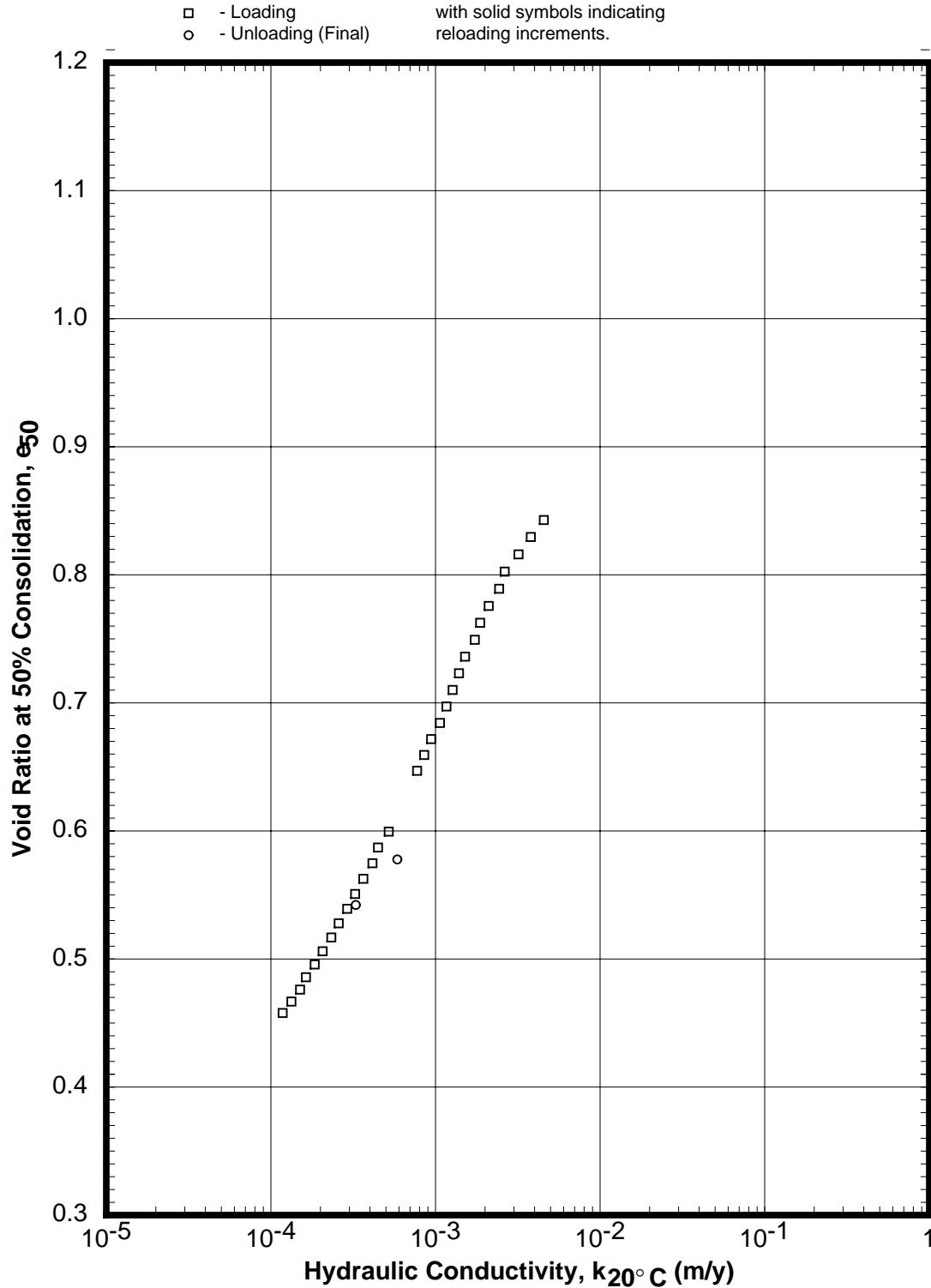

1-D CONSOLIDATION TEST: CRS
 Boring KC151#3 - Sample No. 25(10C-2)a - Depth 224.30 m
 CVX Gulf of Mexico Gas Hydrates JIP
 Block 151, Keathley Canyon Area, Gulf of Mexico

Date:

Drawn By:

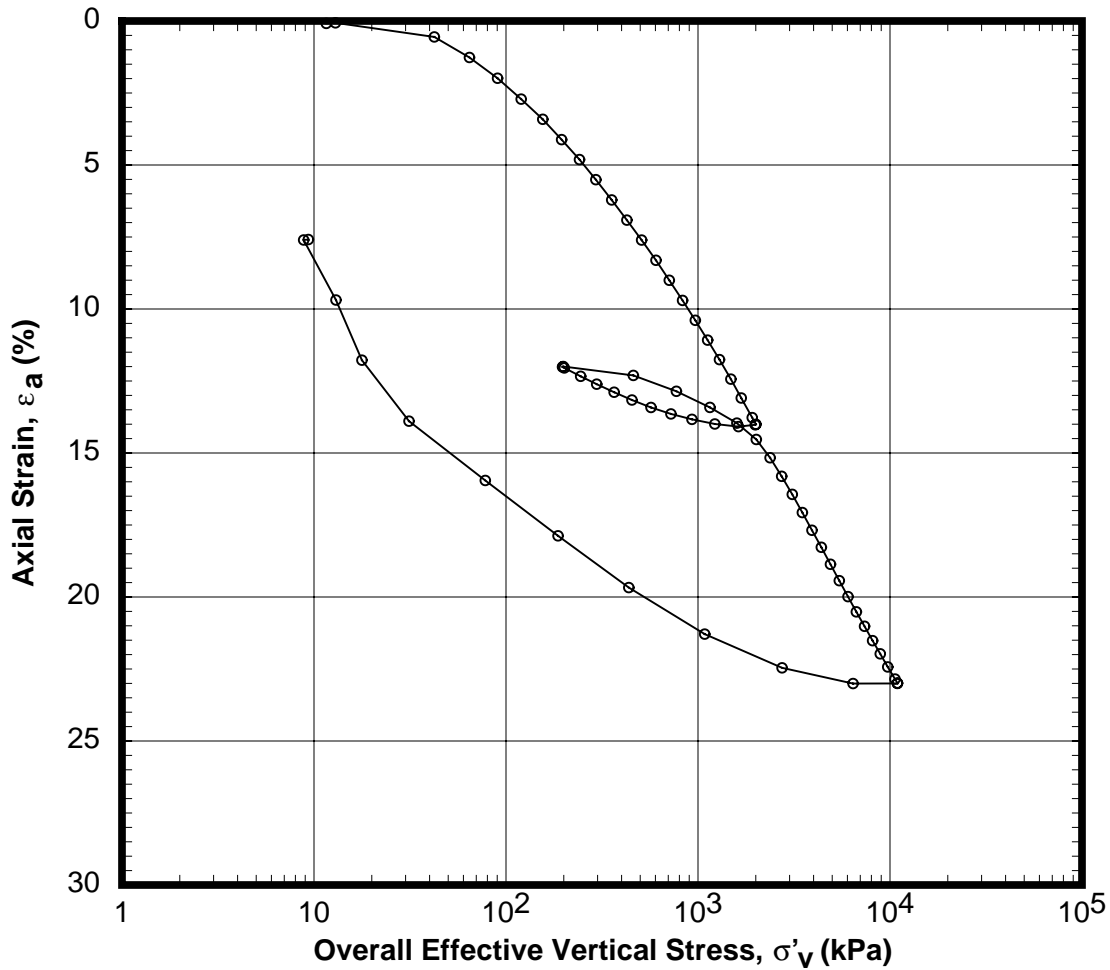

□ - Loading with solid symbols indicating
 ○ - Unloading (Final) reloading increments.

Date:

Date:

Checked By:

Approved By:

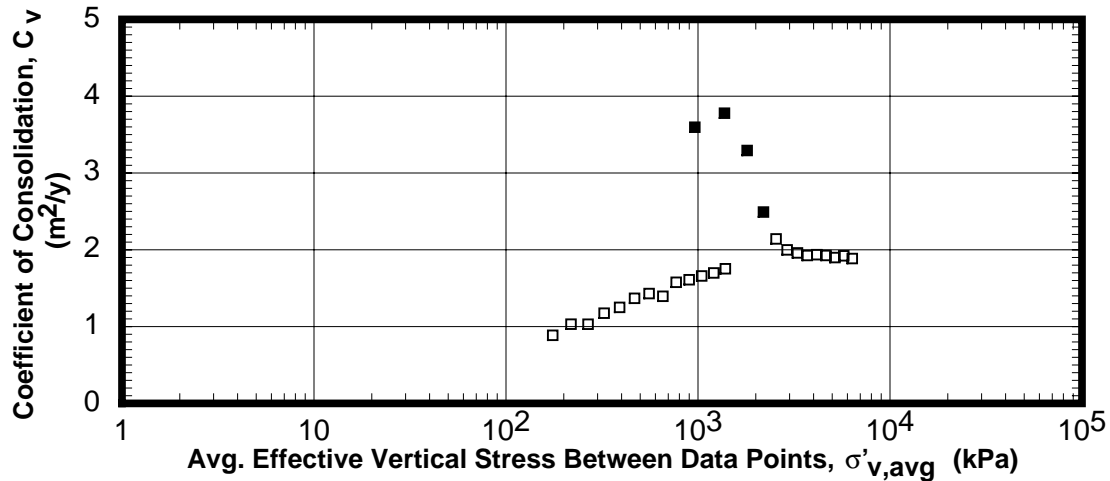

1-D CONSOLIDATION TEST: CRS
 Boring KC151#3 - Sample No. 26(12C-1)a - Depth 230.98 m
 CVX Gulf of Mexico Gas Hydrates JIP
 Block 151, Keathley Canyon Area, Gulf of Mexico

Date:

Drawn By:

Date:

Date:

Checked By:

Approved By:

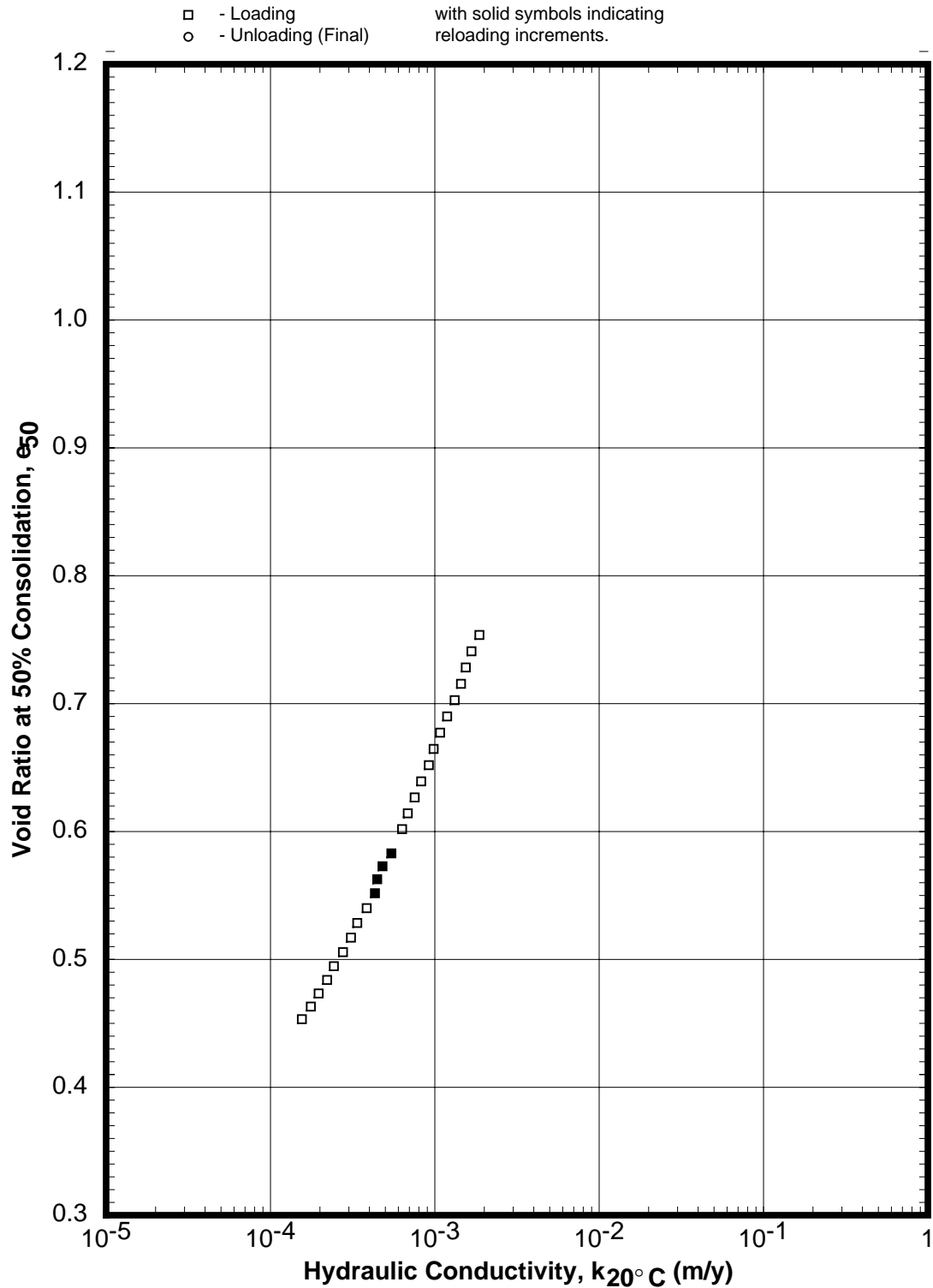

1-D CONSOLIDATION TEST: CRS
 Boring KC151#3 - Sample No. 26(12C-1)a - Depth 230.98 m
 CVX Gulf of Mexico Gas Hydrates JIP
 Block 151, Keathley Canyon Area, Gulf of Mexico

Date:

Drawn By:

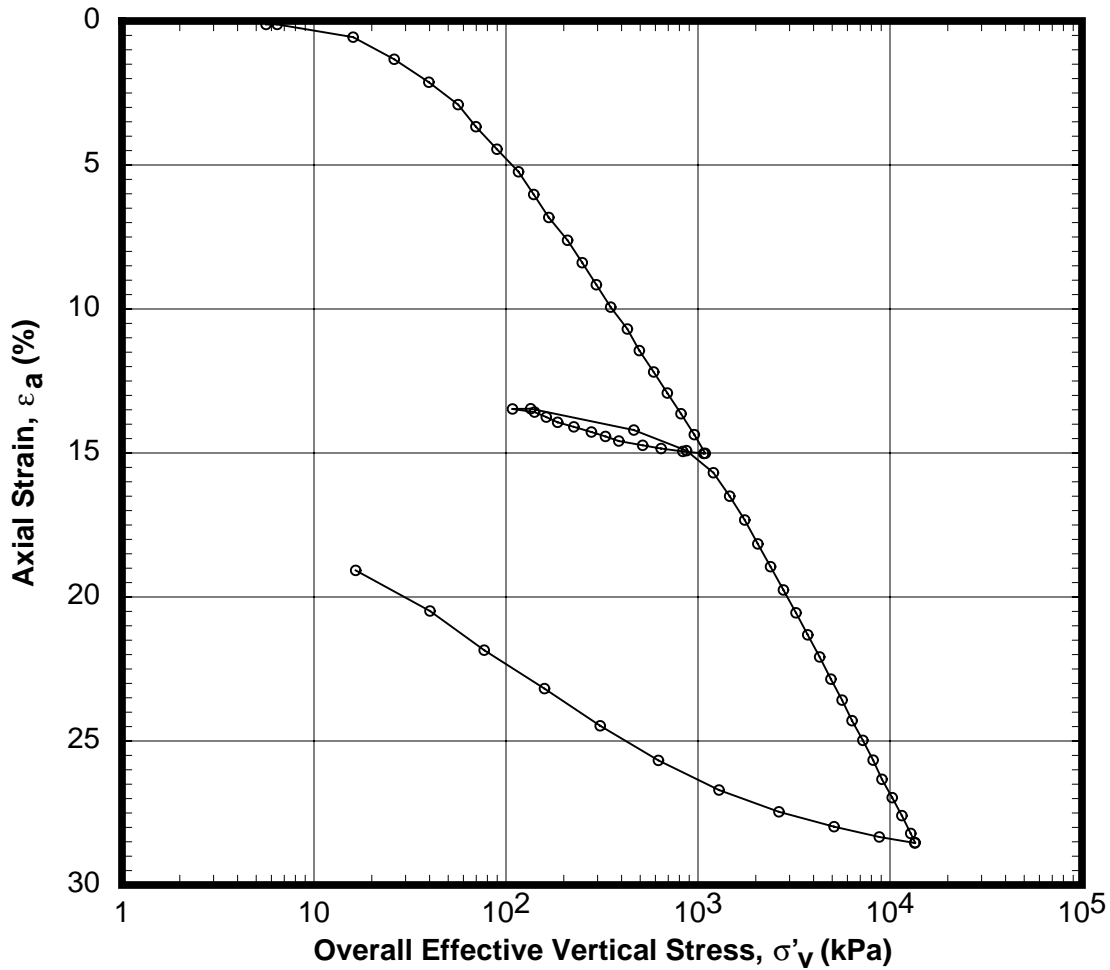

□ - Loading with solid symbols indicating
 ○ - Unloading (Final) reloading increments.

Date:

Date:

Checked By:

Approved By:

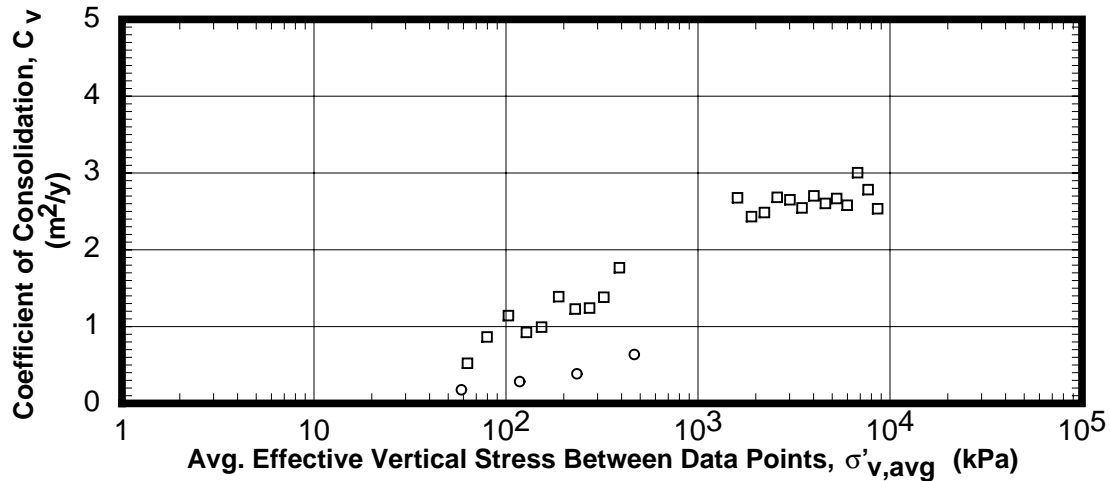

1-D CONSOLIDATION TEST: CRS
 Boring KC151#3 - Sample No. 27(14C-2)a - Depth 243.70 m
 CVX Gulf of Mexico Gas Hydrates JIP
 Block 151, Keathley Canyon Area, Gulf of Mexico

Date:

Drawn By:

Date:

Date:

Checked By:

Approved By:

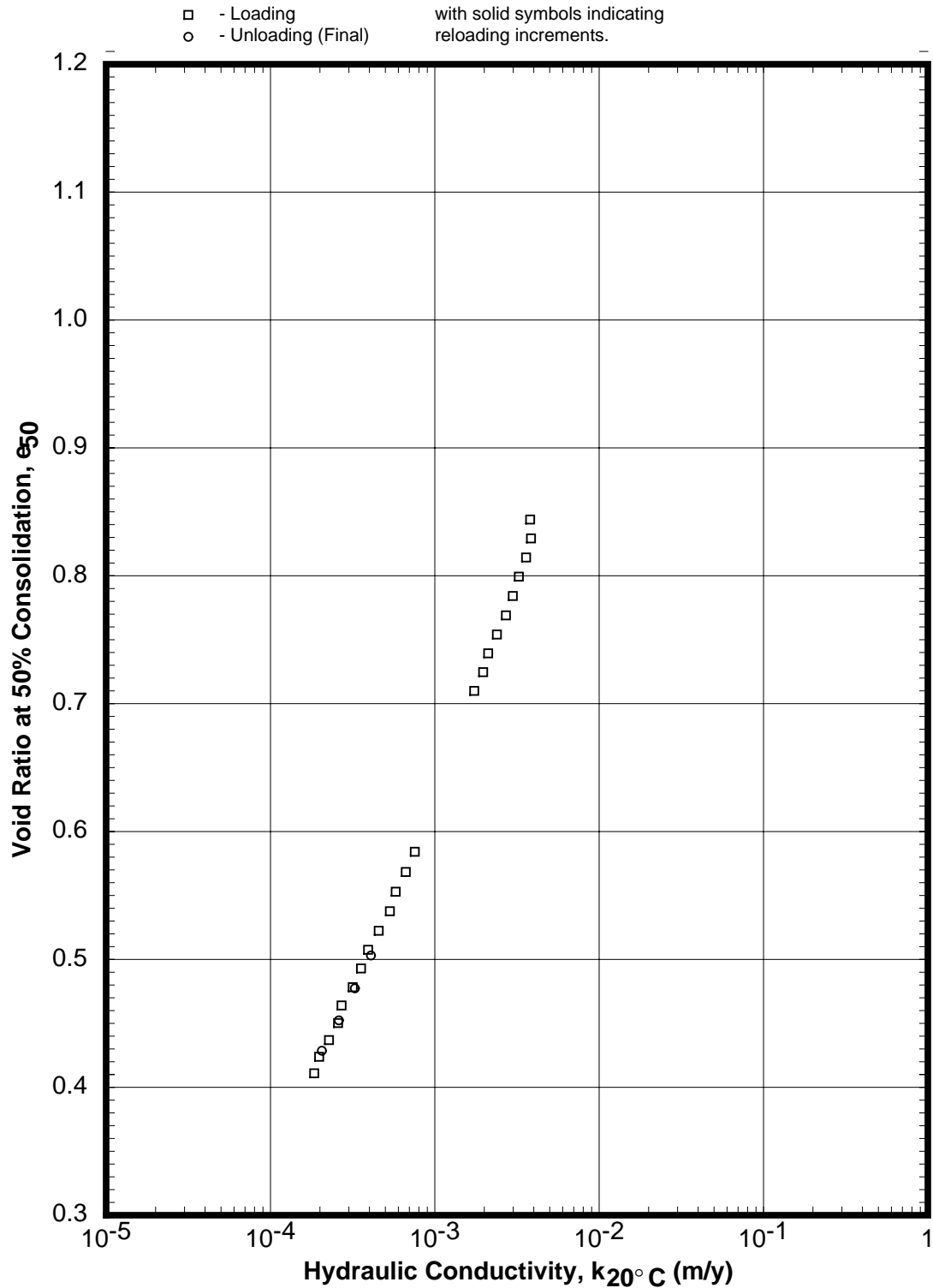

1-D CONSOLIDATION TEST: CRS
 Boring KC151#3 - Sample No. 27(14C-2)a - Depth 243.70 m
 CVX Gulf of Mexico Gas Hydrates JIP
 Block 151, Keathley Canyon Area, Gulf of Mexico

Date:

Drawn By:

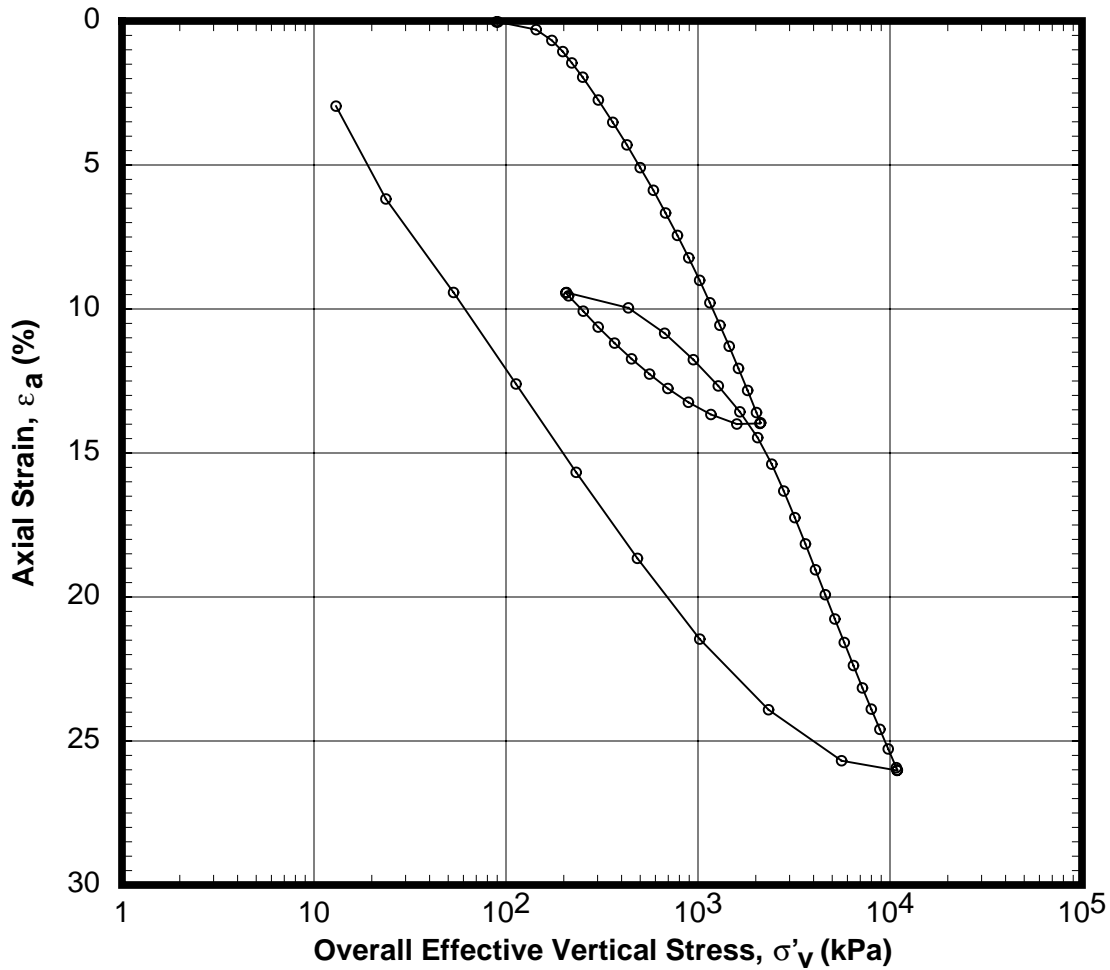

□ - Loading with solid symbols indicating
 ○ - Unloading (Final) reloading increments.

Date:

Date:

Checked By:

Approved By:

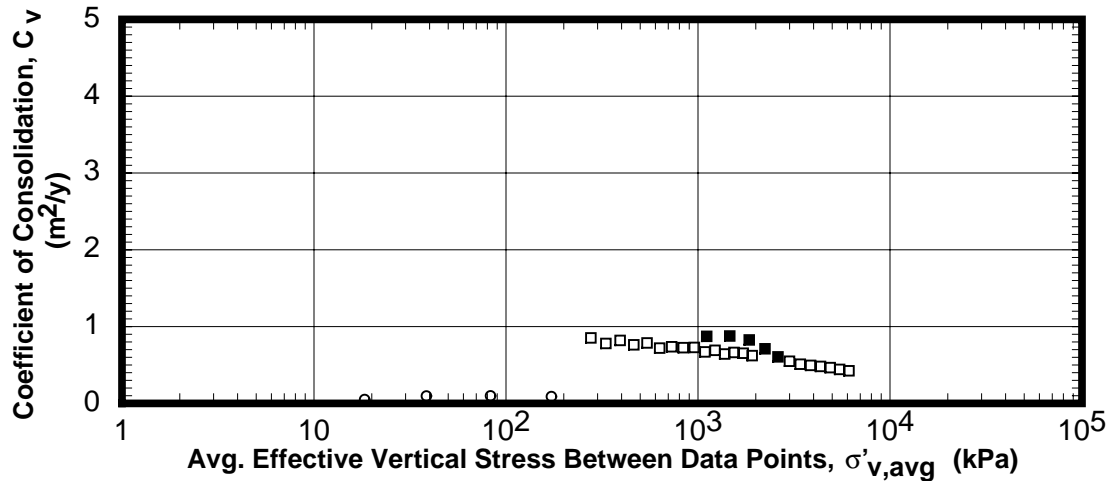

1-D CONSOLIDATION TEST: CRS
 Boring KC151#3 - Sample No. 29(19H-4)a - Depth 278.62 m
 CVX Gulf of Mexico Gas Hydrates JIP
 Block 151, Keathley Canyon Area, Gulf of Mexico

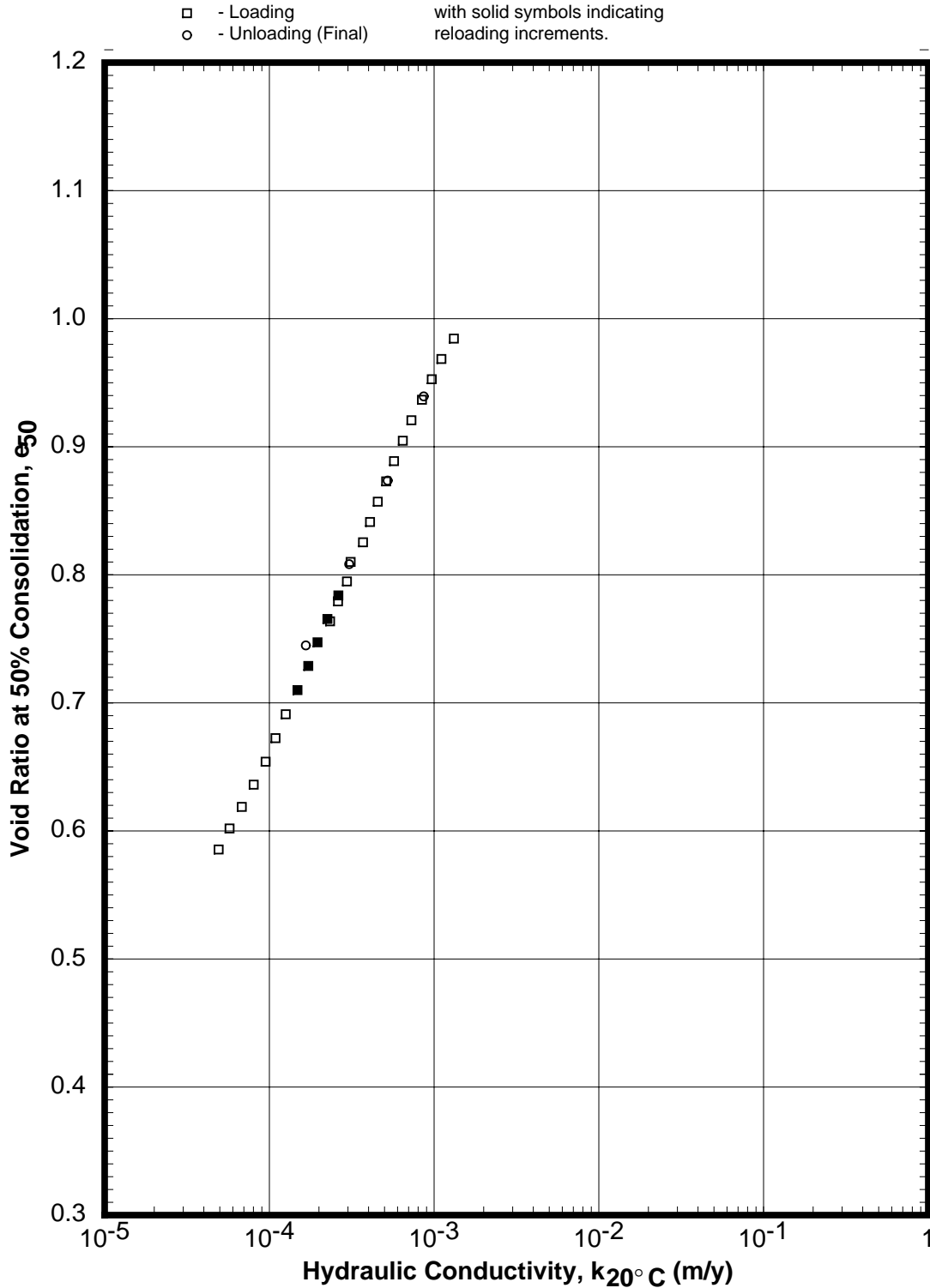

1-D CONSOLIDATION TEST: CRS
 Boring KC151#3 - Sample No. 29(19H-4)a - Depth 278.62 m
 CVX Gulf of Mexico Gas Hydrates JIP
 Block 151, Keathley Canyon Area, Gulf of Mexico

Date:

Drawn By:

Date:

Date:

Checked By:

Approved By:

Date:

Drawn By:

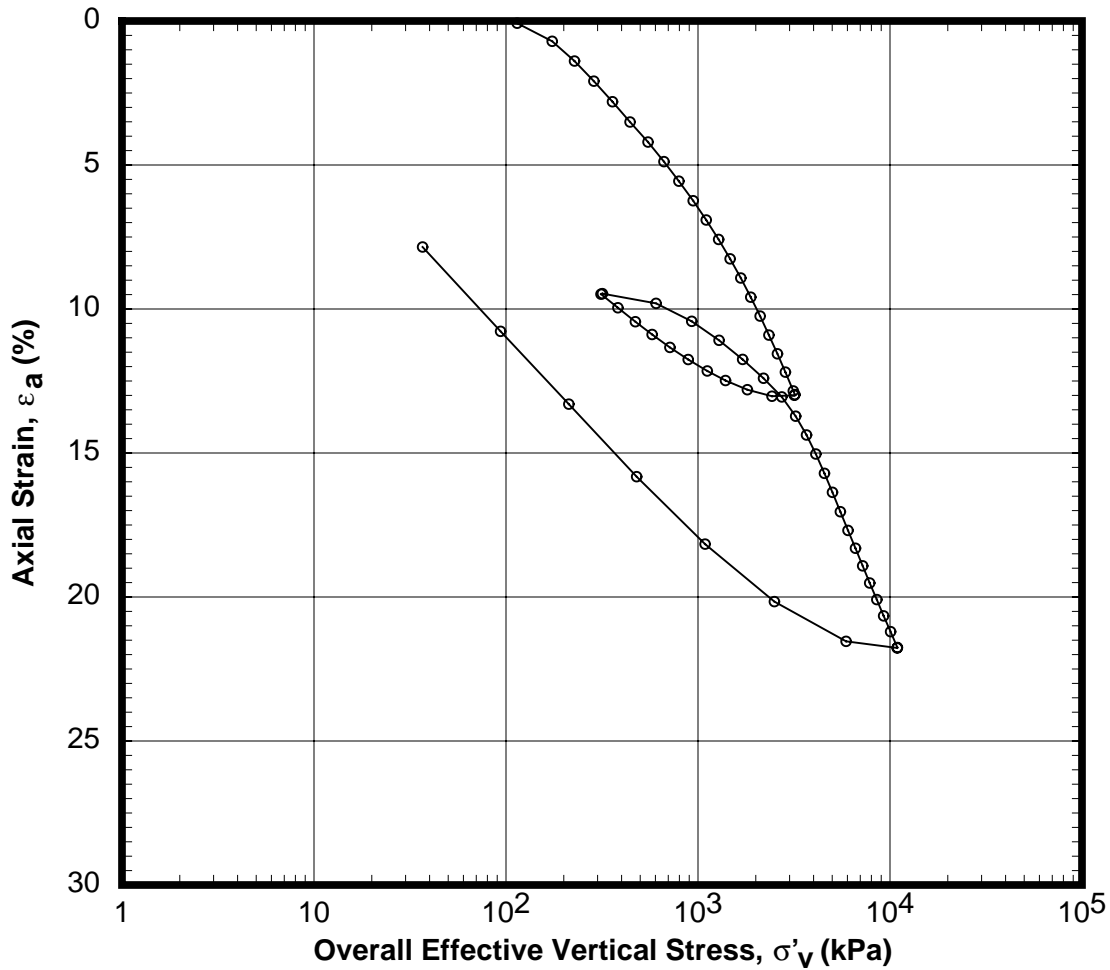

□ - Loading with solid symbols indicating
 ○ - Unloading (Final) reloading increments.

Date:

Date:

Checked By:

Approved By:

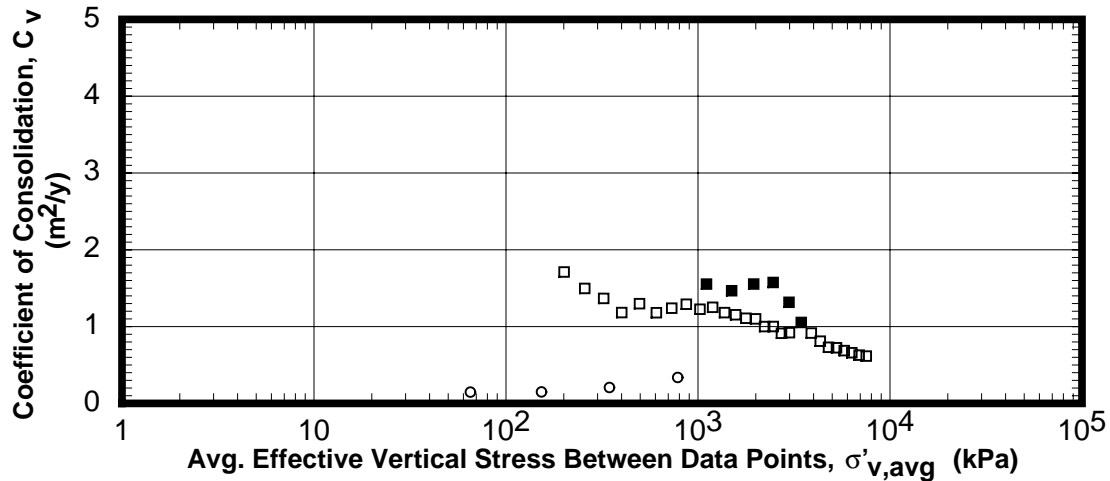

1-D CONSOLIDATION TEST: CRS
 Boring KC151#3 - Sample No. 31(21H-2)a - Depth 313.21 m
 CVX Gulf of Mexico Gas Hydrates JIP
 Block 151, Keathley Canyon Area, Gulf of Mexico

Date:

Drawn By:

Date:

Date:

Checked By:

Approved By:

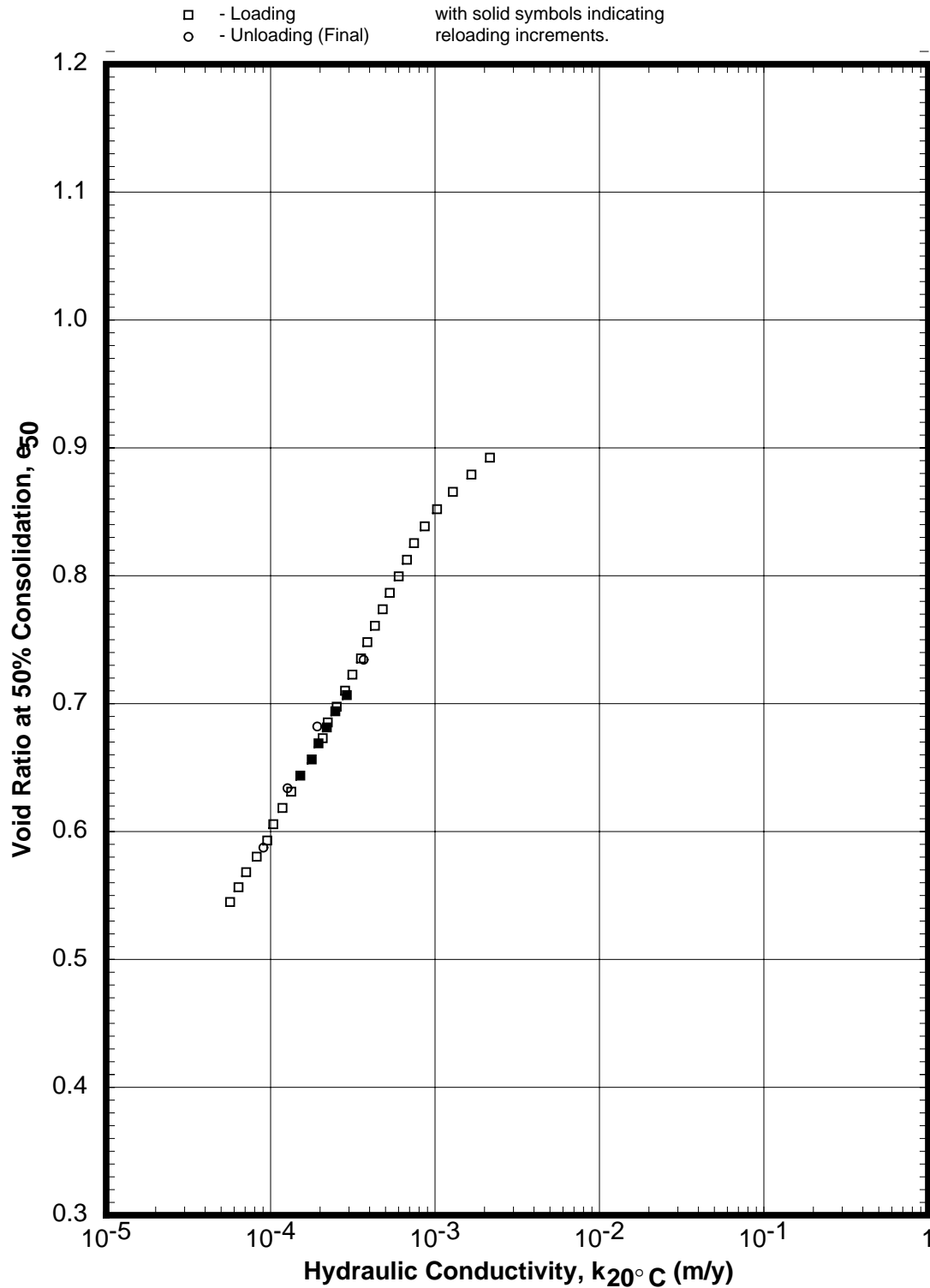

1-D CONSOLIDATION TEST: CRS
 Boring KC151#3 - Sample No. 31(21H-2)a - Depth 313.21 m
 CVX Gulf of Mexico Gas Hydrates JIP
 Block 151, Keathley Canyon Area, Gulf of Mexico

Date:

Drawn By:

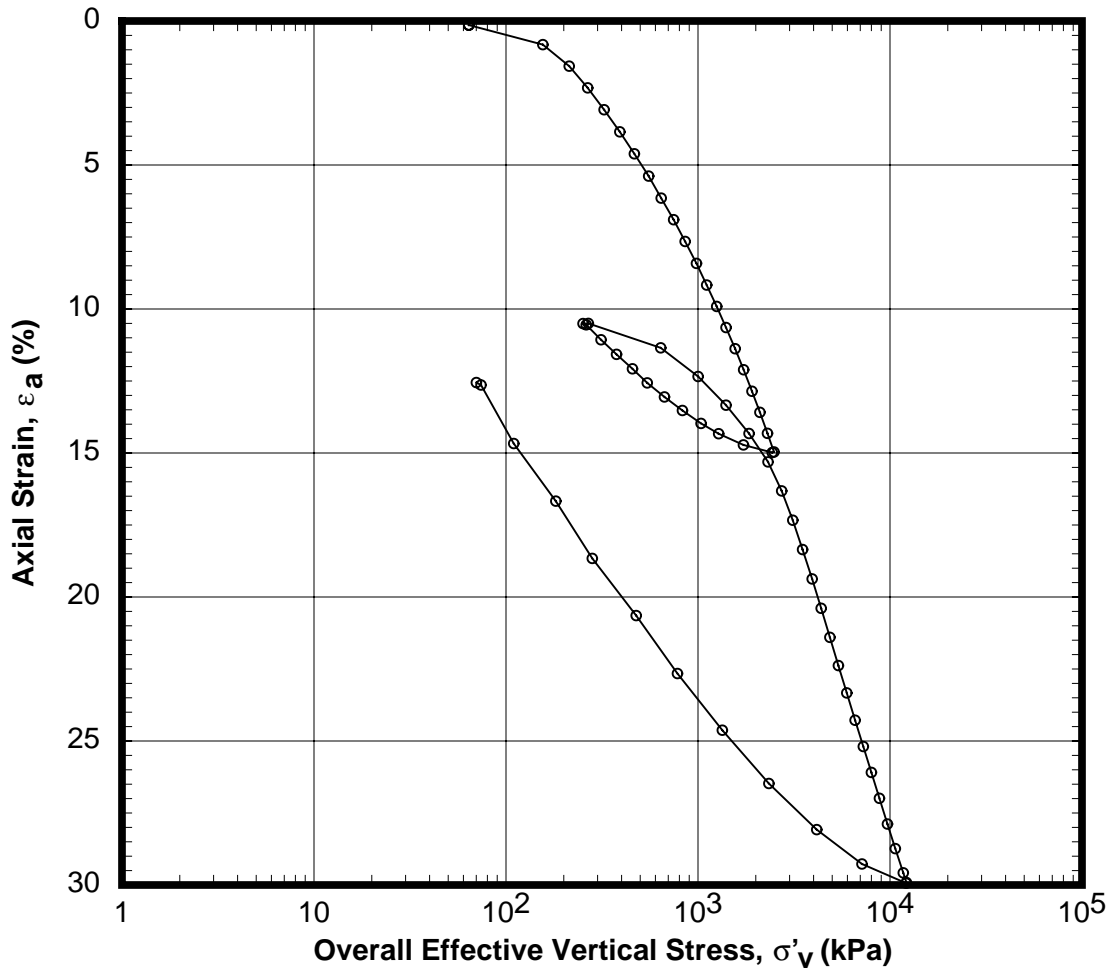

□ - Loading with solid symbols indicating
 ○ - Unloading (Final) reloading increments.

Date:

Date:

Checked By:

Approved By:

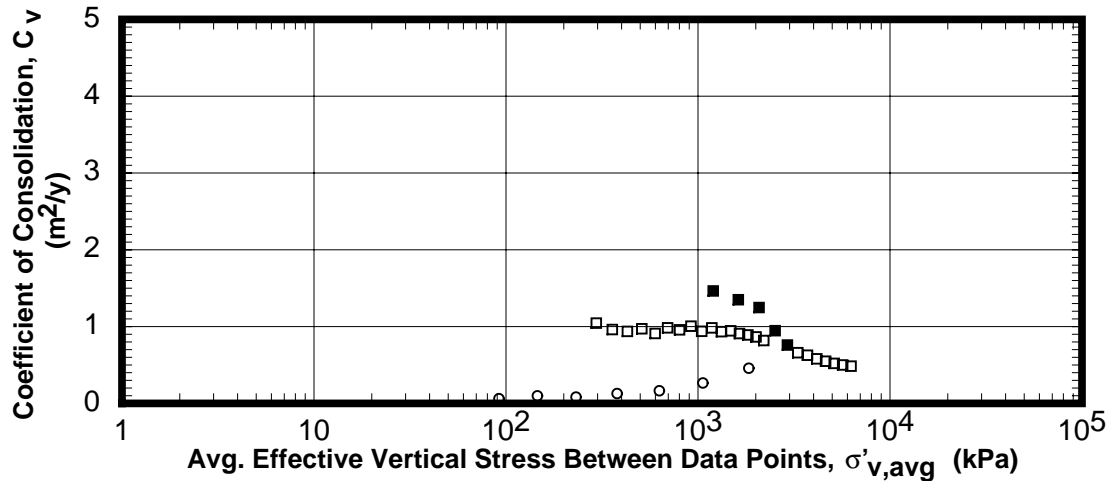

1-D CONSOLIDATION TEST: CRS
 Boring KC151#3 - Sample No. 32(24C-2)a - Depth 370.51 m
 CVX Gulf of Mexico Gas Hydrates JIP
 Block 151, Keathley Canyon Area, Gulf of Mexico

Date:

Drawn By:

Date:

Date:

Checked By:

Approved By:

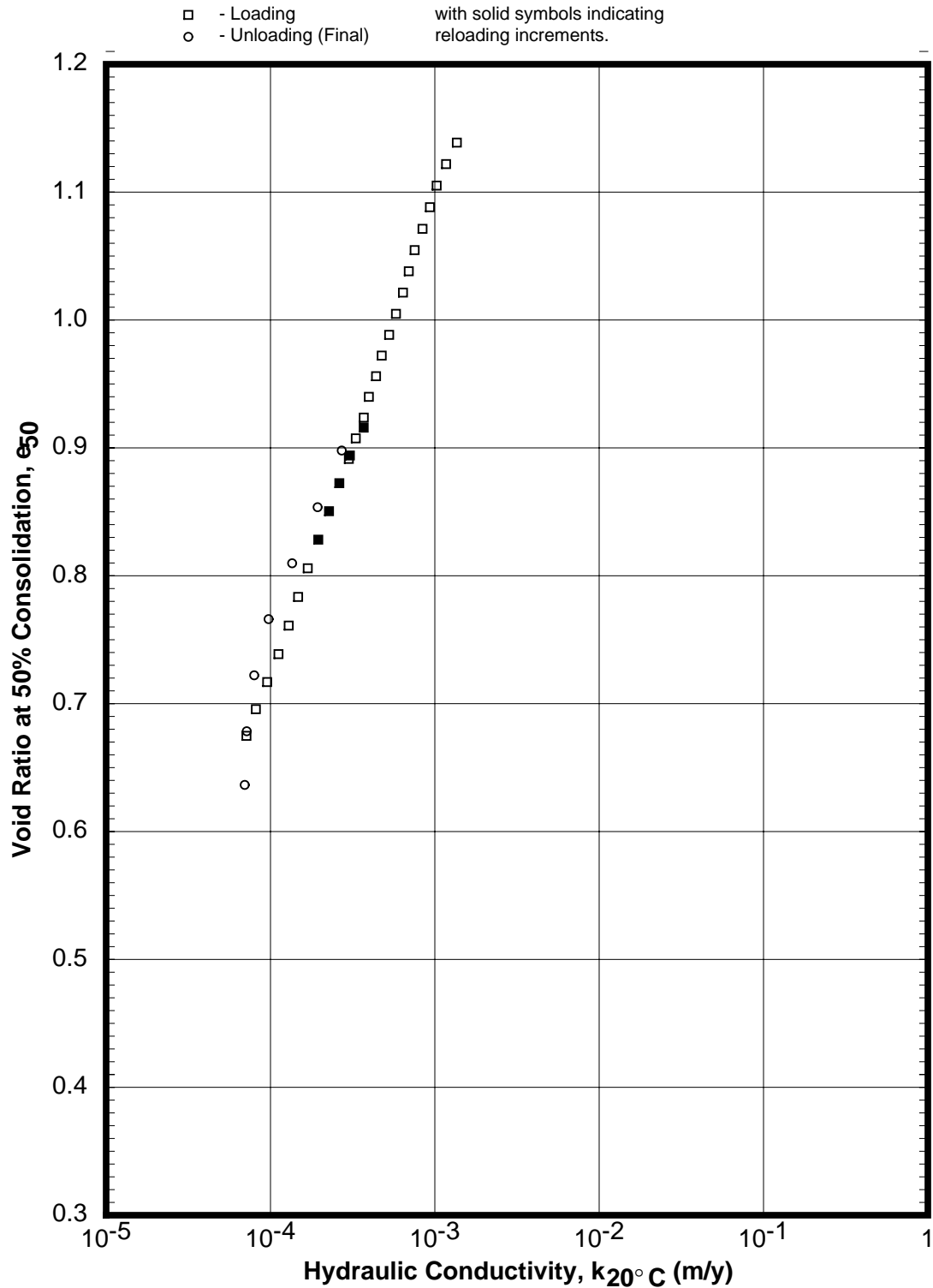

1-D CONSOLIDATION TEST: CRS
 Boring KC151#3 - Sample No. 32(24C-2)a - Depth 370.51 m
 CVX Gulf of Mexico Gas Hydrates JIP
 Block 151, Keathley Canyon Area, Gulf of Mexico

Series &/or Test No.	Boring - Sample - Spec. No.	Penetration or Depth (m)	G _s	Index Properties:								at Peak Shear Stress					c _u σ' _{v,c} Ψ _{DSS} (degrees)
				LL	w _o	γ _{t,o}	S _o	LI _o	σ' _{v,c} (kPa)	ε _{a,max}	γ _{rate} (%/hr)	High Strain					
				PI	w _c (%)	γ _{t,c} (kN/m ³)	S _c (%)	LI _c	Induced OCR	ε _{a,c} (%)	t _c (days)	γ (%)	τ _h (kPa)	τ _h σ' _v	Δ U σ' _{v,c}		
1	20b (5H-6)	42.35	2.750	59	39.3	17.5	94.7	0.468	288.5	8.43	5.0	14.1	86.0	0.470	0.366	0.298	
				37	35.1	18.5	100.0	0.354	1.00	8.43	0.4	29.3	56.3	0.474	0.589	27.33	
2	22c (6C-1)	100.69	2.750	38	33.0	18.2	93.8	0.784	719.7	12.03	4.9	15.1	196.8	0.446	0.387	0.273	
				23	26.7	19.7	100.0	0.509	1.00	12.03	0.7	30.0	141.0	0.490	0.600	26.1	
3	23b (7C-1)	210.22	2.750	67	38.7	18.2	100.7	0.371	577.3	11.50	4.9	10.2	171.9	0.390	0.237	0.298	
				45	29.9	19.2	100.7	0.176	1.00	11.50	1.4	29.0	111.7	0.418	0.538	24.27	
4	25b (10C-2)	224.21	2.750	52	29.6	18.8	95.5	0.299	722.1	13.57	4.9	13.9	172.1	0.374	0.362	0.238	
				32	21.8	20.5	100.0	0.055	1.00	13.57	0.8	29.6	132.1	0.495	0.630	26.32	
5	26b (12C-1)	230.93	2.750	44	29.1	19.4	100.9	0.380	967.6	13.42	4.9	16.6	298.2	0.448	0.312	0.308	
				24	19.8	21.0	100.9	-0.009	1.00	13.42	0.9	29.3	228.1	0.495	0.524	26.35	
6	27b (14C-2)	243.75	2.750	47	33.0	18.9	100.9	0.500	482.7	13.58	4.9	15.7	135.2	0.444	0.369	0.280	
				28	23.3	20.3	100.9	0.154	1.00	13.58	0.9	29.7	104.6	0.536	0.596	28.19	
7	29b (19H-4)	278.54	2.750	74	32.9	17.9	90.3	0.195	1438.1	13.61	5.1	12.6	268.8	0.268	0.302	0.187	
				51	26.5	19.7	100.0	0.069	1.00	13.61	0.9	29.1	197.2	0.276	0.503	16.00	
8	31b (21H-2)	313.17	2.750	61	28.1	18.9	93.2	0.177	1932.1	14.28	4.9	12.2	392.9	0.316	0.357	0.203	
				40	20.2	20.8	100.0	-0.021	1.00	14.28	0.7	29.8	258.4	0.364	0.633	20.26	
9	32b (24C-2)	370.56	2.750	85	39.4	17.8	97.4	0.253	2302.8	18.39	4.9	12.5	449.2	0.274	0.288	0.195	
				61	26.3	19.7	100.0	0.037	1.00	18.39	0.8	29.6	319.1	0.285	0.514	16.18	

Test No.	Description of Tested Soil, Test Remarks, and Supplemental Data:	Plate No.
1	Clay, olive gray	B-33
2	Clay, olive gray, with silt seams	B-34
3	Clay, olive gray	B-35
4	Clay, olive gray	B-36
5	Clay, olive gray	B-37
6	Clay, olive gray	B-38
7	Clay, olive gray, with silt pockets	B-39
8	Clay, olive gray	B-40
9	Clay, olive gray	B-41

█ Indicates value was copied from adjacent test specimen or assumed.

SUMMARY OF STATIC DSS TESTS: VERSUS DEPTH

K_o Consolidation - OCR = 1

Boring KC151#3

Block 151, Keathley Canyon Area, Gulf of Mexico



Date:

Drawn By:

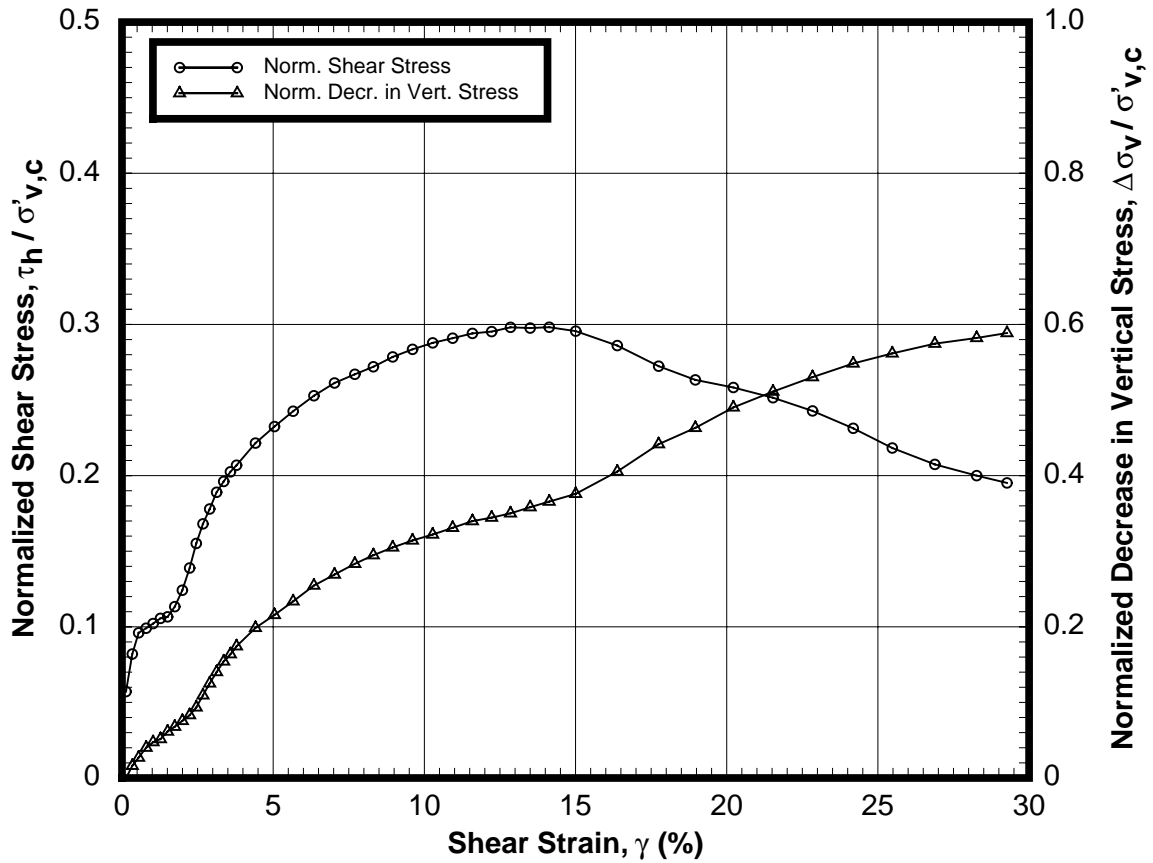

Date:

Date:

Checked By:

Approved By:

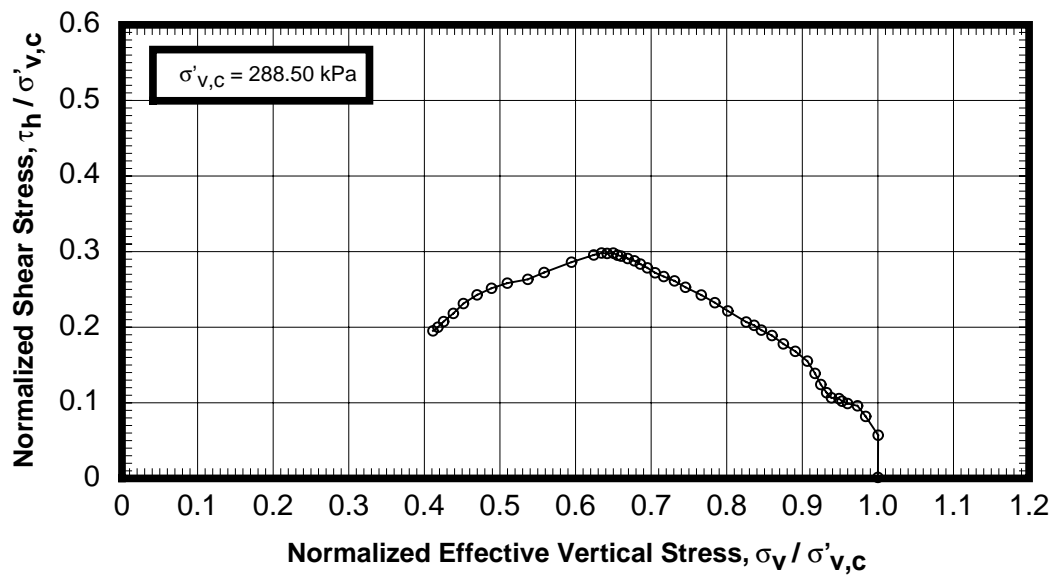

STATIC DSS TEST

K_0 Consolidation - OCR = 1

Boring KC151#3 - Sample No. 20(5H-6)b - Depth 42.35 m

CVX Gulf of Mexico Gas Hydrates JIP

Block 151, Keathley Canyon Area, Gulf of Mexico

Date:

Drawn By:

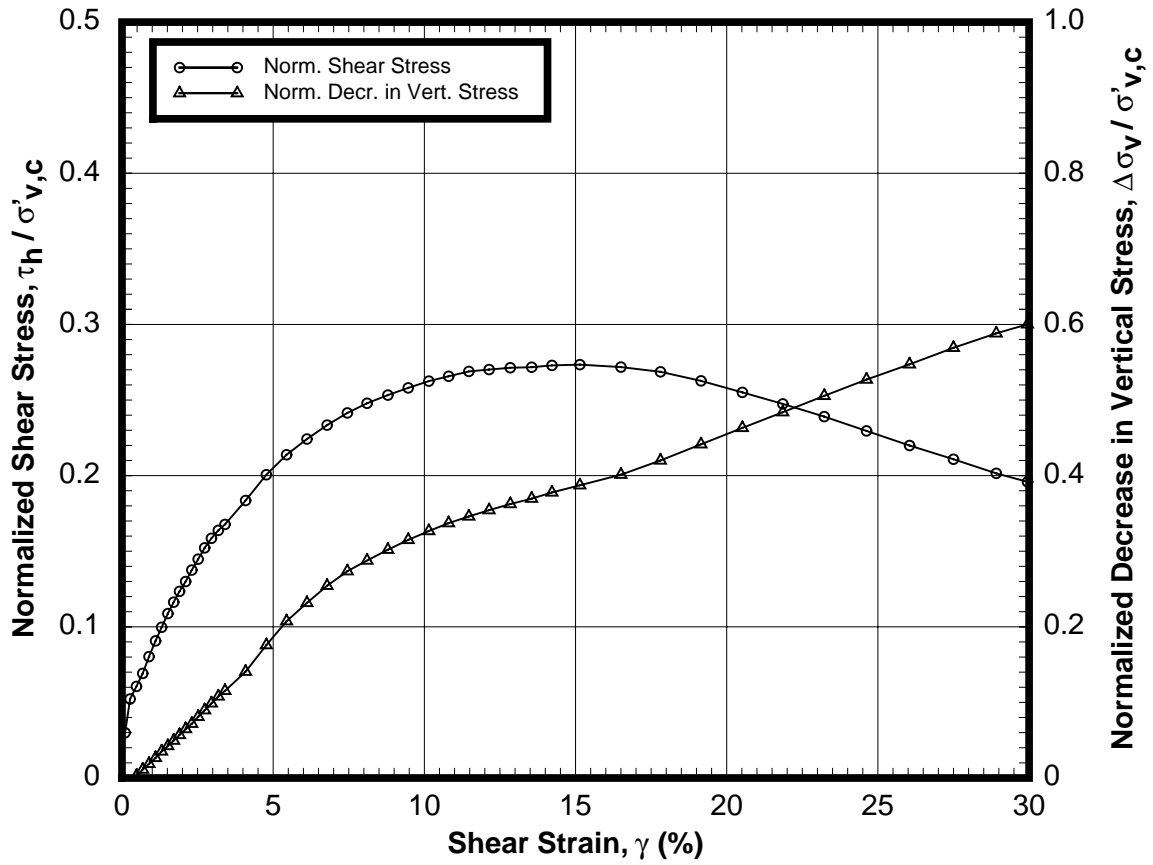

Date:

Date:

Checked By:

Approved By:

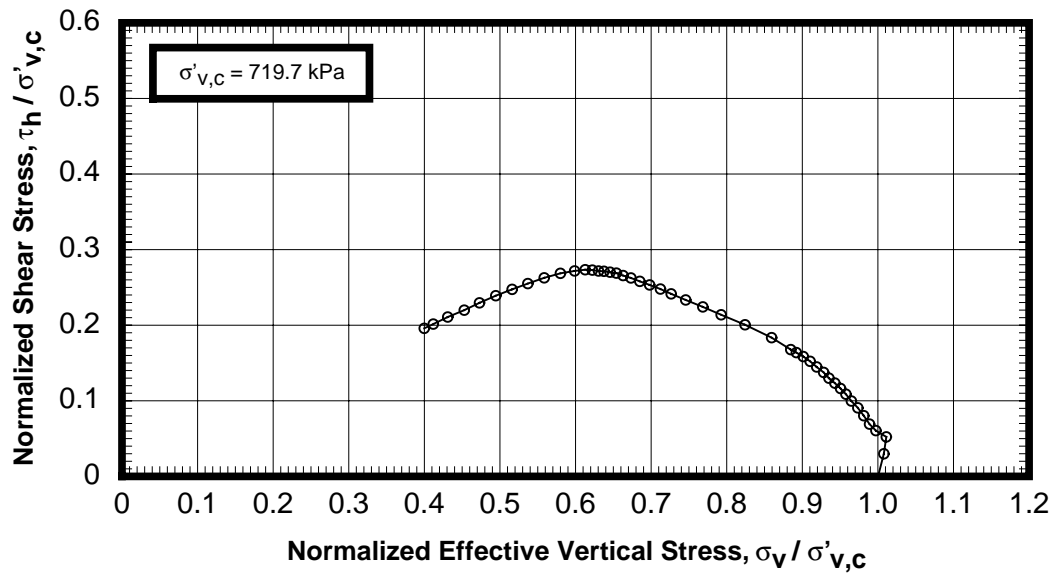

STATIC DSS TEST

K_0 Consolidation - OCR = 1

Boring KC151#3 - Sample No. 22(6C-1)c - Depth 100.69 m

CVX Gulf of Mexico Gas Hydrates JIP

Block 151, Keathley Canyon Area, Gulf of Mexico

Date:

Drawn By:

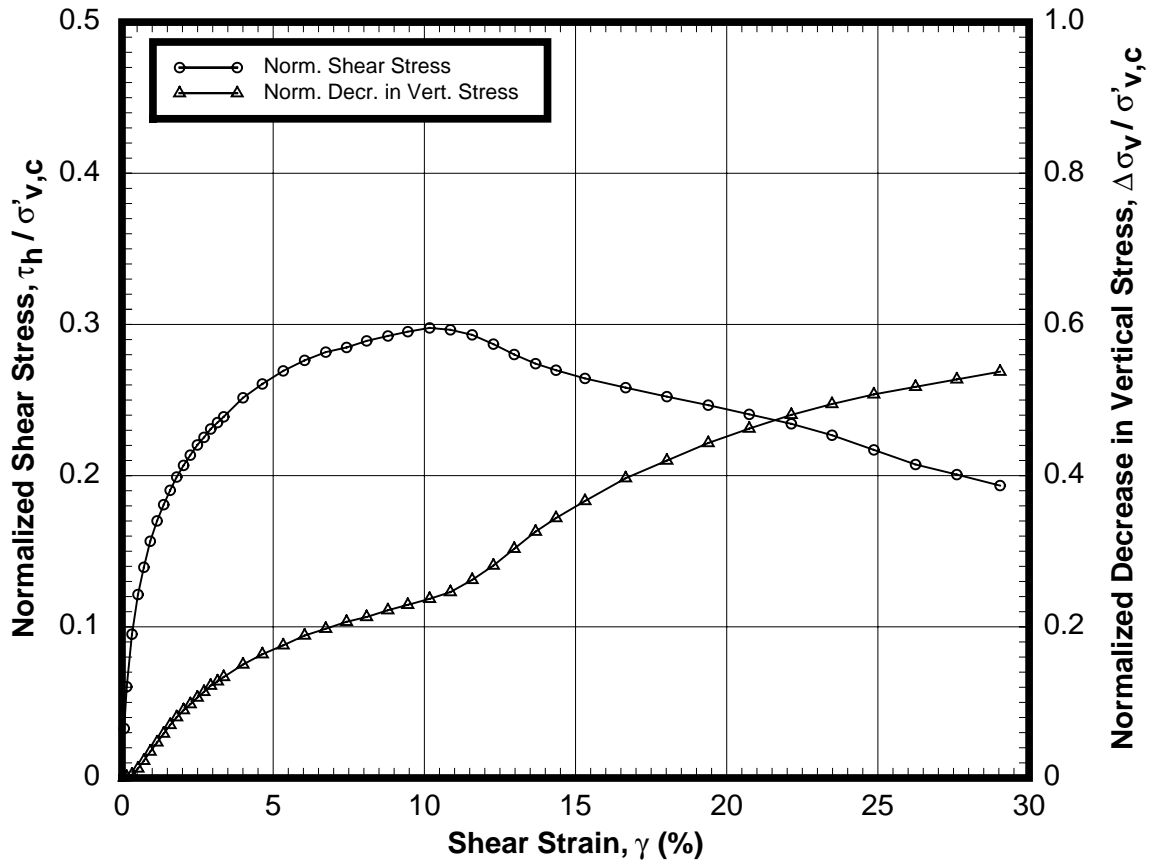

Date:

Checked By:
Approved By:

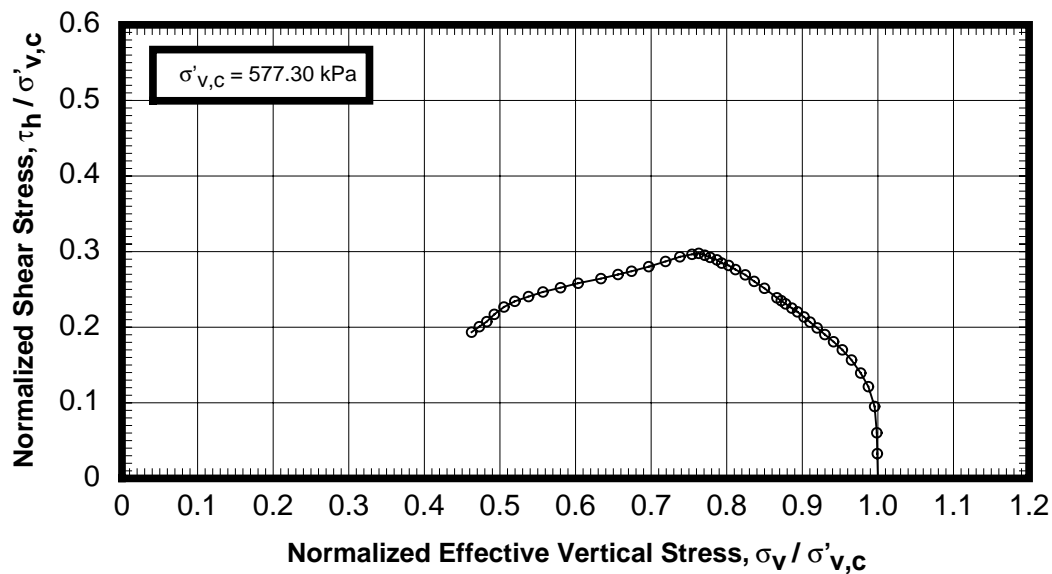

STATIC DSS TEST

K_0 Consolidation - OCR = 1

Boring KC151#3 - Sample No. 23(7C-1)b - Depth 210.22 m

CVX Gulf of Mexico Gas Hydrates JIP

Block 151, Keathley Canyon Area, Gulf of Mexico

Date:

Drawn By:

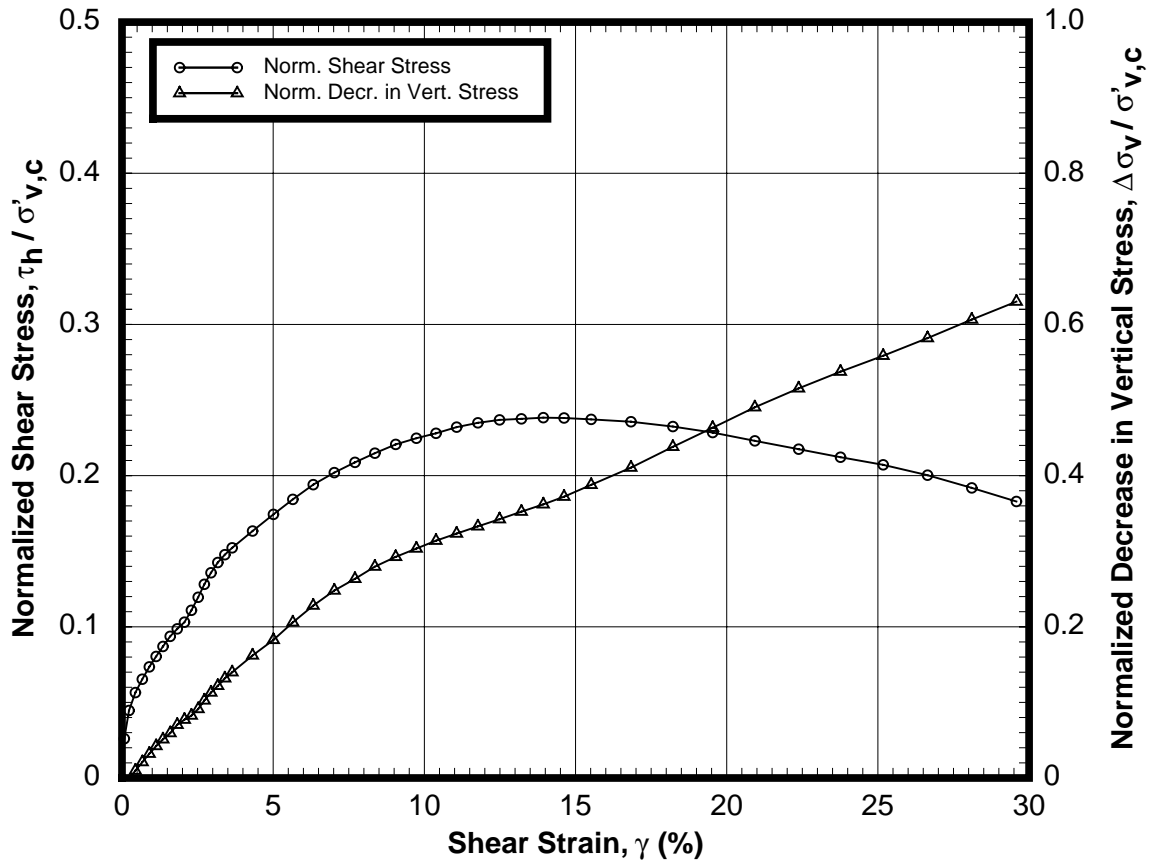

Date:

Checked By:
Approved By:

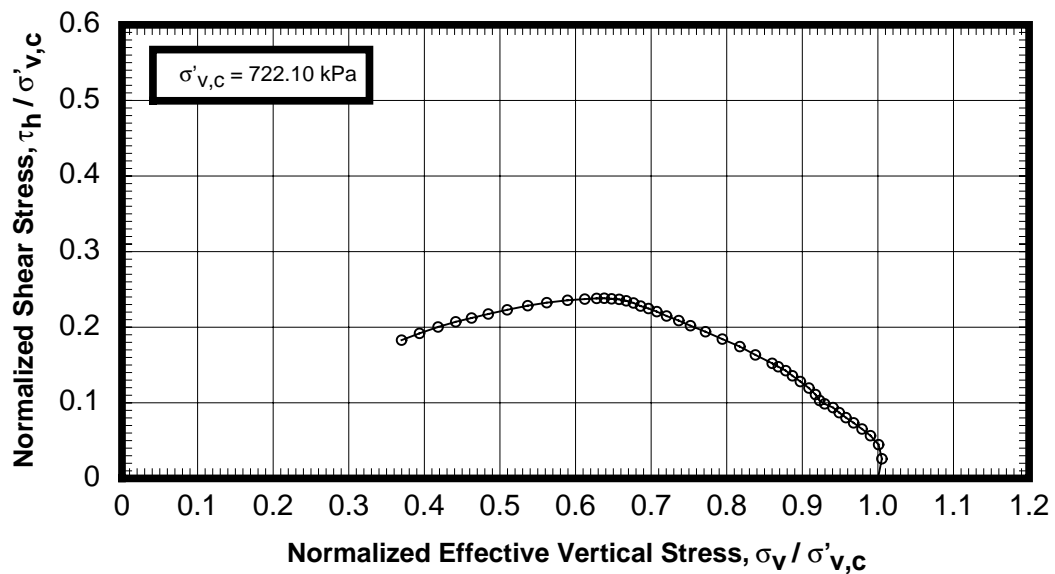

STATIC DSS TEST

K_0 Consolidation - OCR = 1

Boring KC151#3 - Sample No. 25(10C-2)b - Depth 224.21 m

CVX Gulf of Mexico Gas Hydrates JIP

Block 151, Keathley Canyon Area, Gulf of Mexico

Date:

Drawn By:

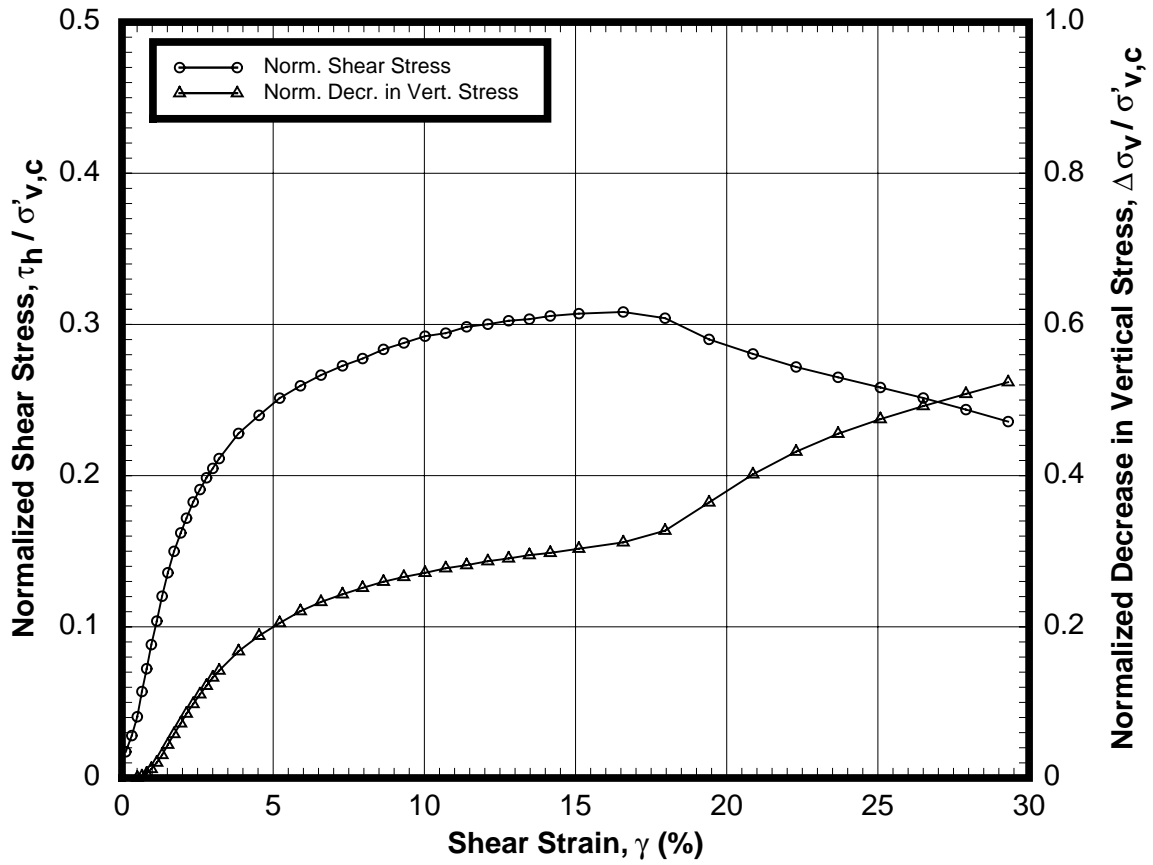

Date:

Checked By:
Approved By:

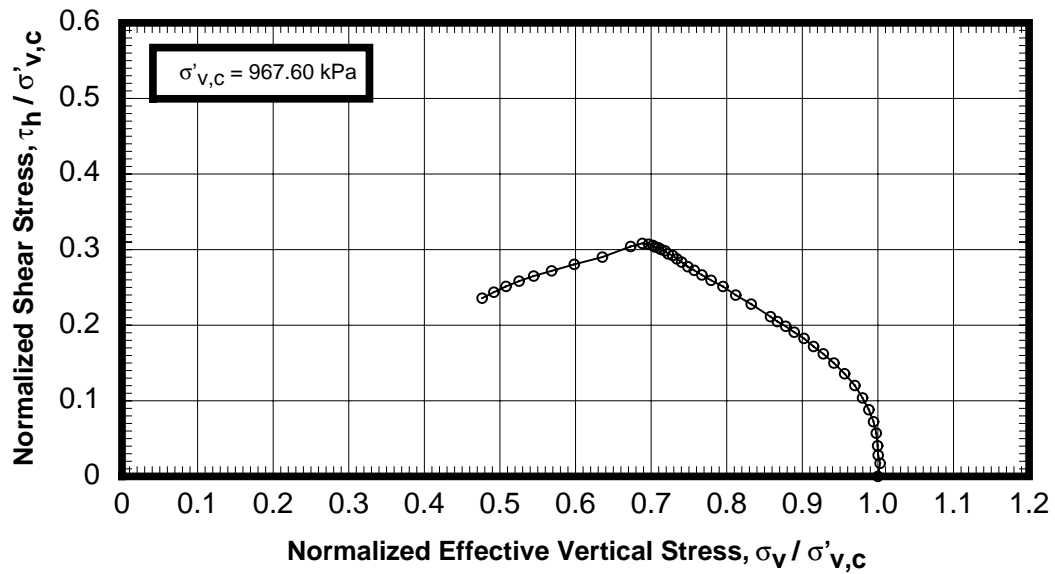

STATIC DSS TEST

K_0 Consolidation - OCR = 1

Boring KC151#3 - Sample No. 26(12C-1)b - Depth 230.93 m

CVX Gulf of Mexico Gas Hydrates JIP

Block 151, Keathley Canyon Area, Gulf of Mexico

Date:

Drawn By:

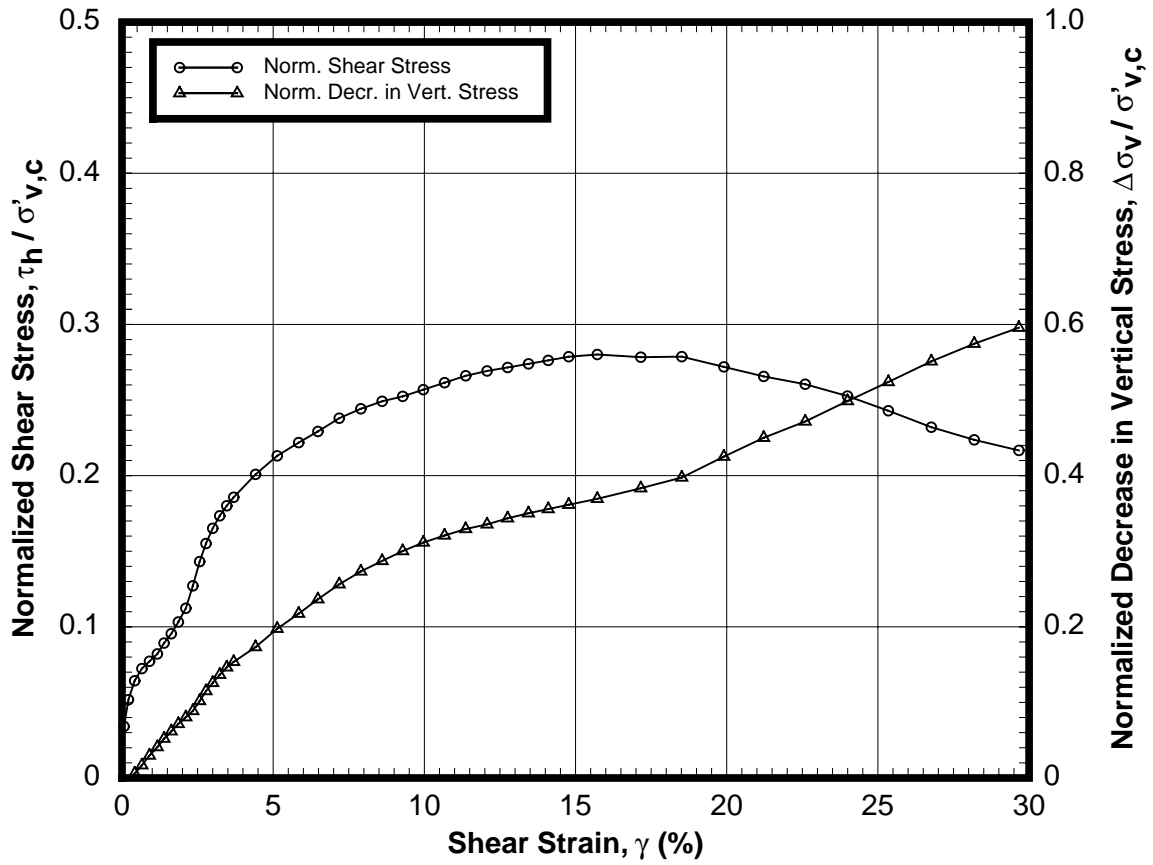

Date:

Checked By:
Approved By:

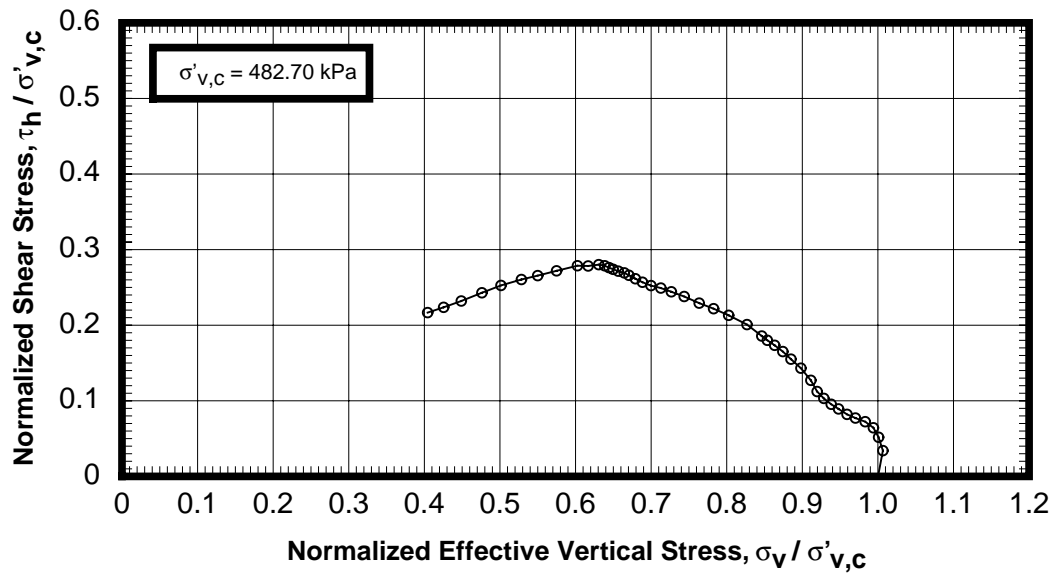

STATIC DSS TEST

K_0 Consolidation - OCR = 1

Boring KC151#3 - Sample No. 27(14C-2)b - Depth 243.75 m

CVX Gulf of Mexico Gas Hydrates JIP

Block 151, Keathley Canyon Area, Gulf of Mexico

Date:

Drawn By:

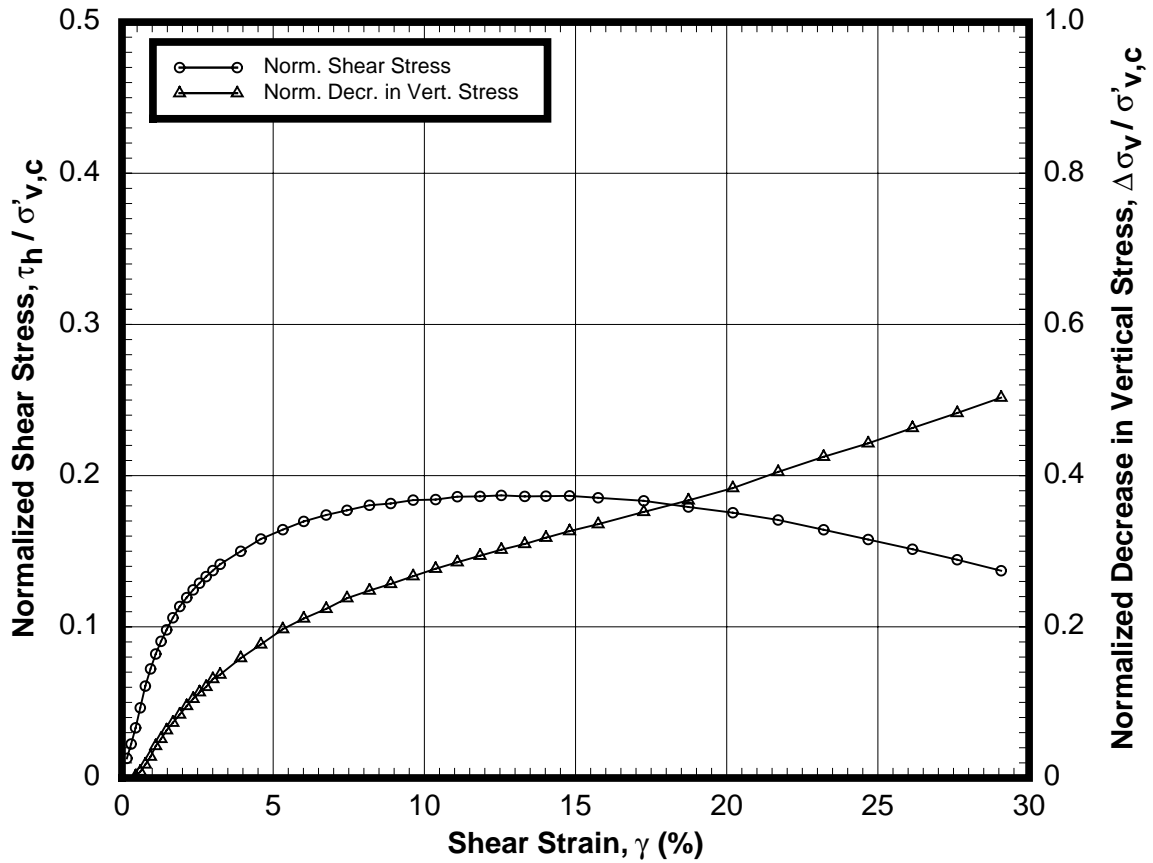

Date:

Date:

Checked By:

Approved By:

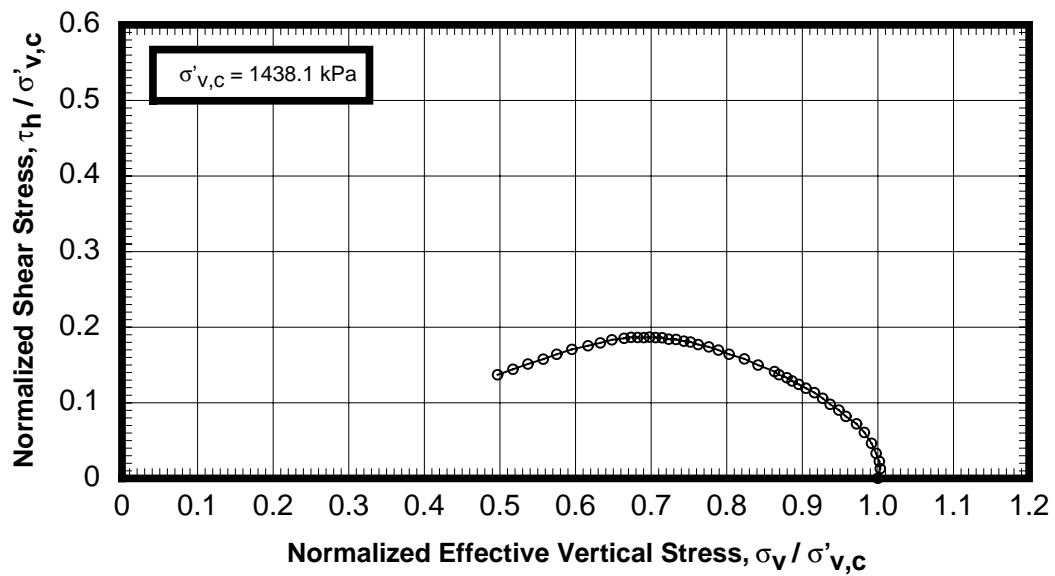

STATIC DSS TEST

K_0 Consolidation - OCR = 1

Boring KC151#3 - Sample No. 29(19H-4)b - Depth 278.54 m

CVX Gulf of Mexico Gas Hydrates JIP

Block 151, Keathley Canyon Area, Gulf of Mexico

Date:

Drawn By:

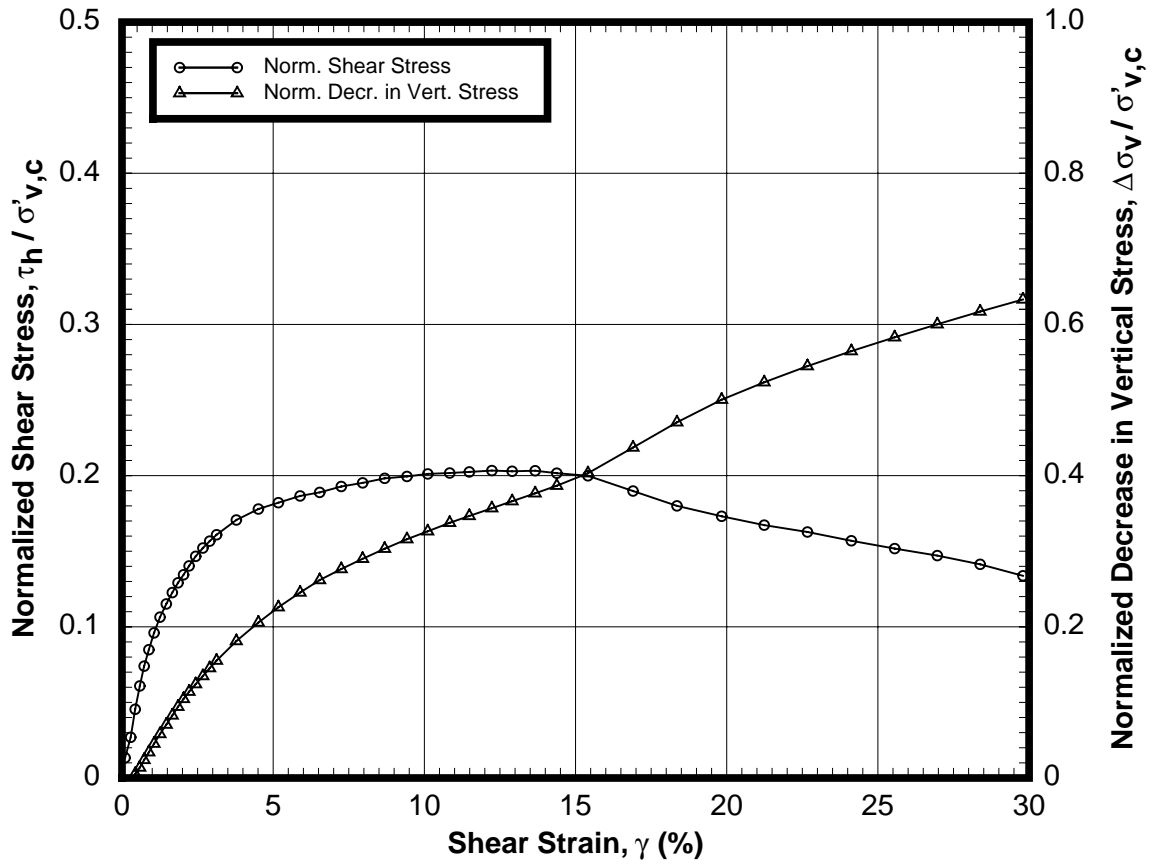

Date:

Checked By:
Approved By:

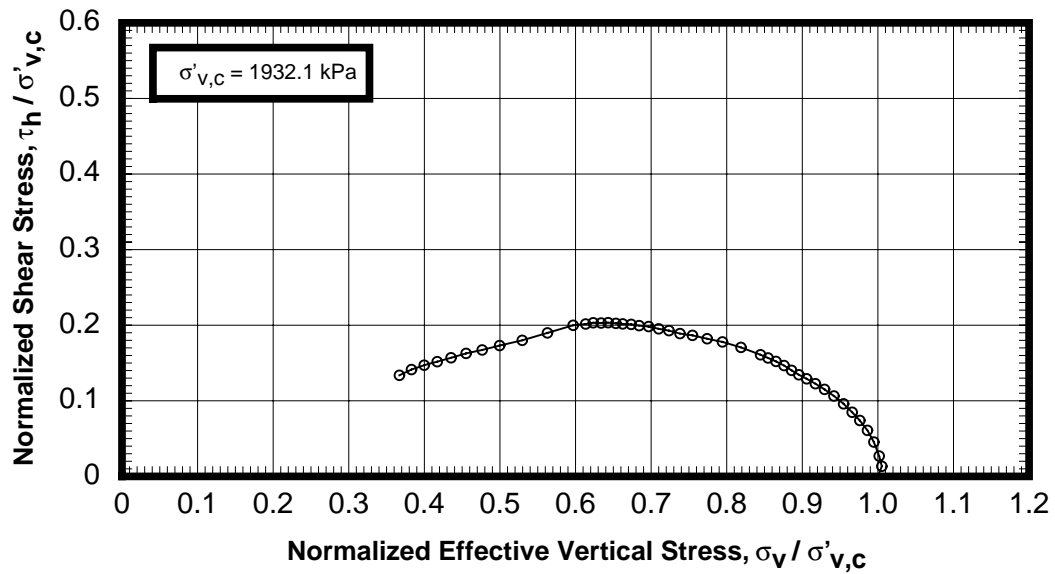

STATIC DSS TEST

K_0 Consolidation - OCR = 1

Boring KC151#3 - Sample No. 31(21H-2)b - Depth 313.17 m

CVX Gulf of Mexico Gas Hydrates JIP

Block 151, Keathley Canyon Area, Gulf of Mexico

Date:

Drawn By:

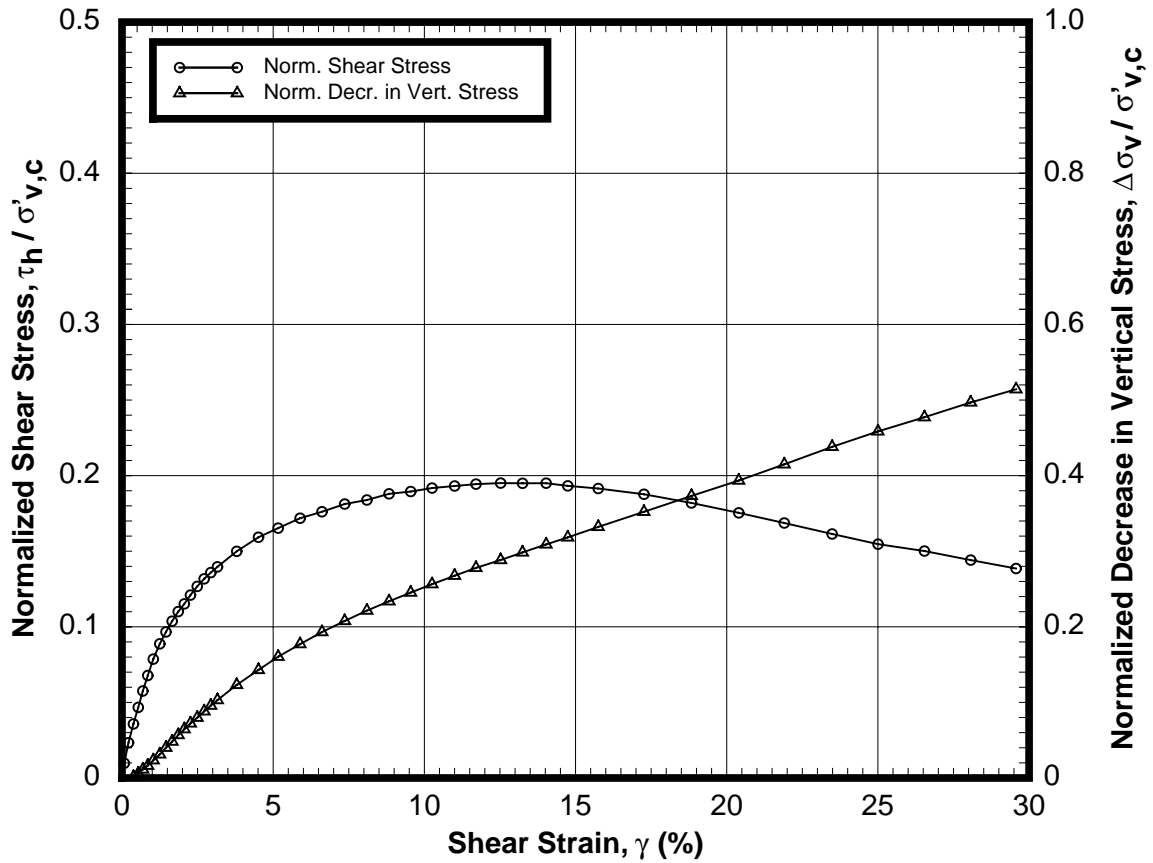

Date:

Checked By:
Approved By:

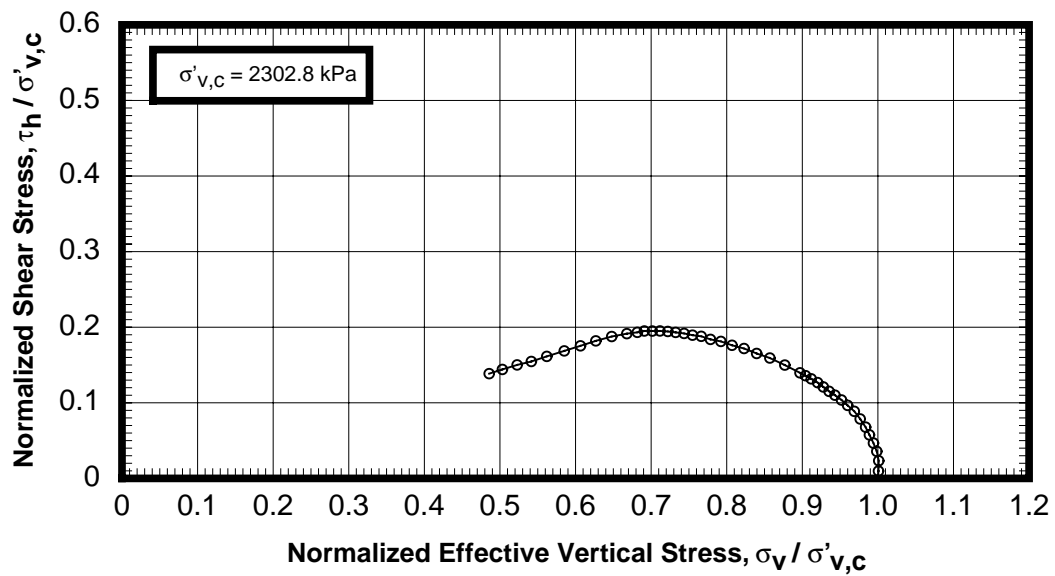

STATIC DSS TEST

K_0 Consolidation - OCR = 1

Boring KC151#3 - Sample No. 32(24C-2)b - Depth 370.56 m

CVX Gulf of Mexico Gas Hydrates JIP

Block 151, Keathley Canyon Area, Gulf of Mexico

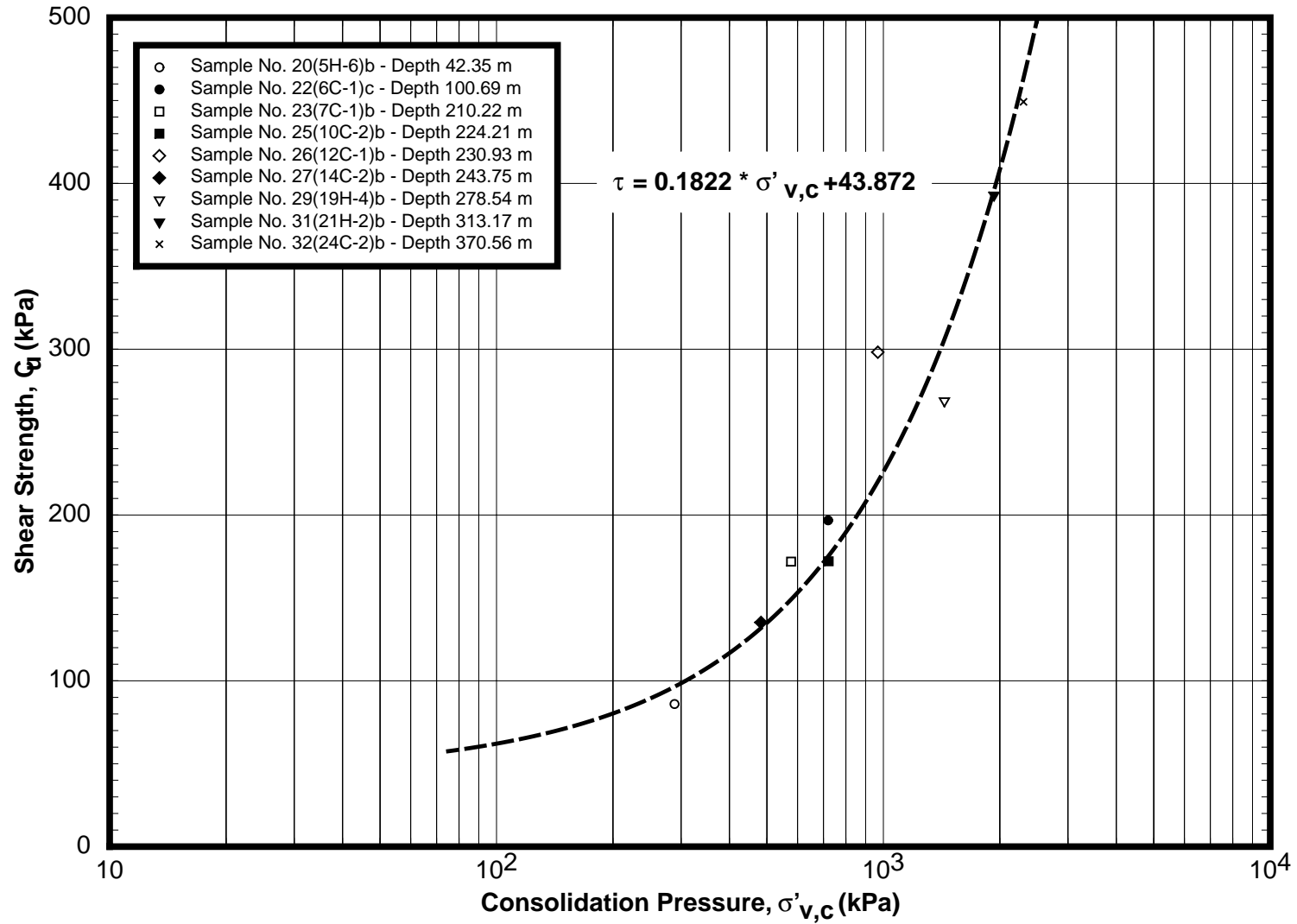

SHEAR STRESS VERSUS CONSOLIDATION PRESSURE

Static DSS Tests - K_0 Consolidation - OCR = 1
Boring KC151#3 - CVX Gulf of Mexico Gas Hydrates JIP
Block 151, Keathley Canyon Area, Gulf of Mexico

Series &/or Test No.	Sample - Spec. No.	Penetration or Depth (m)	G _s	Index Properties:						σ' _{v,c} (kPa)	K ₀ = σ' _{h,c} /σ' _{v,c}	ε _{a,c} (%)	ε _{a,rate} (%/hr)	at Peak Shear Stress						c _u /σ' _{v,c} ⁽¹⁾
				LL	w _o	γ _{t,o}	S _o	LI _o	at Peak Stress Ratio (Obliquity)											
				PI	w _c (%)	γ _{t,c} (kN/m ³)	S _c	LI _c	Induced OCR					B-Value (%)	ε _{v,c} (%)	t _c (days)	ε _a (%)	q/σ' _{v,c}	p'/σ' _{v,c}	ΔU'/σ' _{v,c}
1	AT13#2 12a	23.59	2.750	79	57.8	16.5	100.6	0.614	235.6	0.59	14.8	-0.5	-14.7	-0.284	0.426	-0.119	5.007	0.210		
				55	43.6	17.6	100.2	0.357	1.00	107	14.8	3.0	-14.9	-0.283	0.420	-0.119	5.117	42.3		
2	AT13#2 18a	41.30	2.750	84	53.1	16.6	98.7	0.517	278.0	0.55	12.3	-0.5	-14.4	-0.244	0.442	-0.141	3.463	0.203		
				64	43.5	17.7	100.6	0.367	1.00	100	11.7	3.0	-13.2	-0.243	0.439	-0.135	3.488	33.7		
3	KC151#3 24(8C-2)a	216.62	2.750	71	32.4	18.3	93.6	0.196	1038.9	0.57	11.1	-0.5	-11.2	-0.198	0.445	-0.070	2.608	0.177		
				48	26.9	19.7	101.2	0.081	1.00	95	11.4	3.0	-10.4	-0.197	0.439	-0.065	2.629	26.7		
4	KC151#3 28(17H-3)a	258.99	2.750	82	39.4	17.3	92.8	0.240	1011.0	0.61	10.5	-0.5	-13.4	-0.234	0.533	-0.164	2.570	-0.210		
				56	37.5	18.2	99.5	0.204	1.00	95	6.2	4.0	-13.4	-0.234	0.533	-0.164	2.570	26.1		
5																				
6																				

Test No.	Description of Tested Soil , Test Remarks, and Supplemental Data	Back Pressure (kPa)	Plate No.
1	Clay, olive gray with ferrous shell fragments	339.0	B-12
2	Clay, olive gray with sand pockets	341.7	B-13
3	Clay, olive gray	340.9	B-44
4	Clay, olive gray with few sand pockets	478.9	B-45
5			
6			

Notes: Indicates value was copied from adjacent test specimen or assumed.

$$^{(1)} c_u = q_{u,f} \times \cos \phi'_{c=0}$$

SUMMARY OF STATIC TRUEPATH K₀ TRIAXIAL TESTS
 Boring AT13#2, Block 13, Atwater Valley Area
 Boring KC151#3, Block 151, Keathley Canyon Area



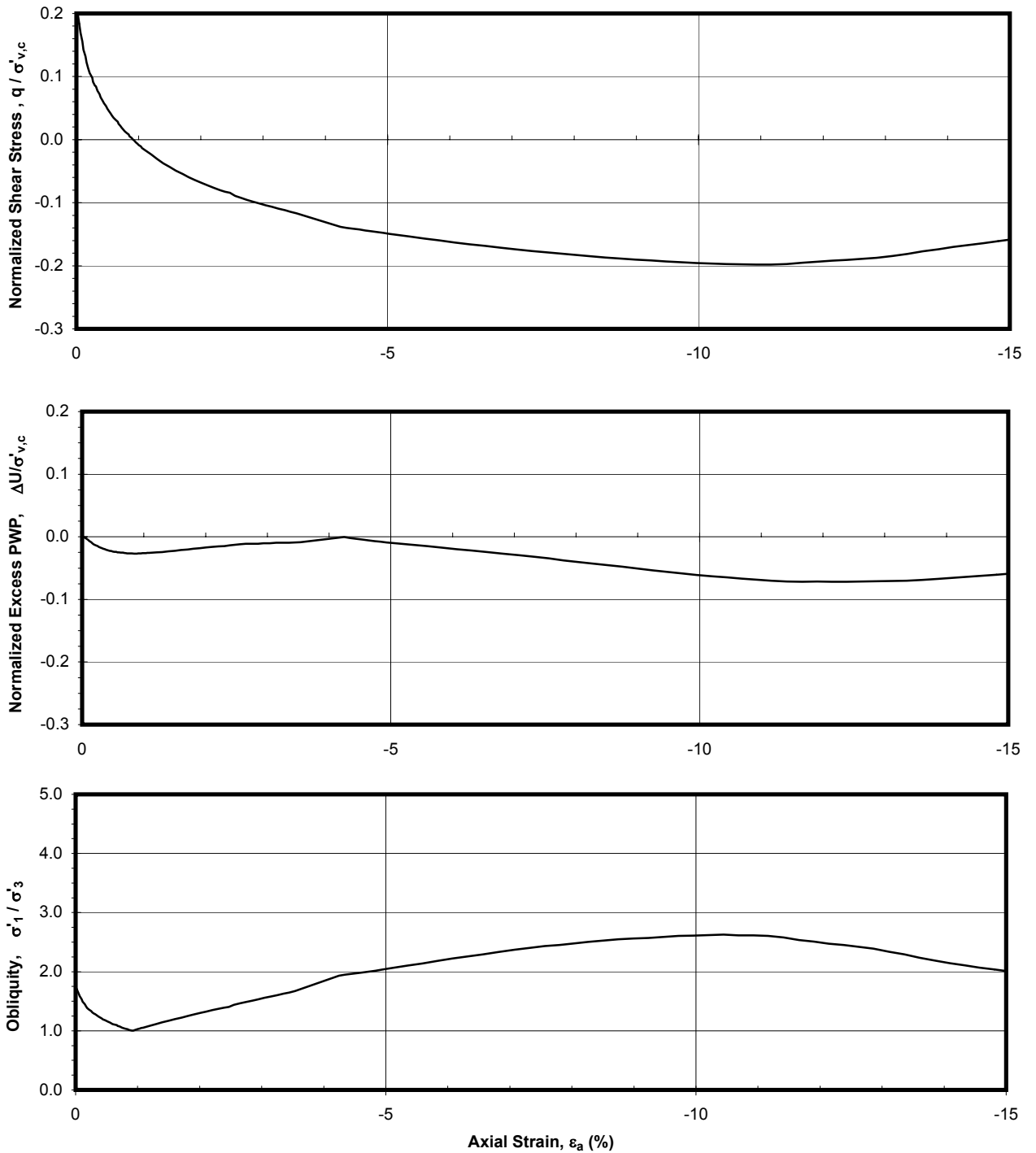

STATIC TRUEPATH TRIAXIAL TEST
 K_o Consolidated - OCR = 1 - Extension
 Sample: 24(8C-2)a - Depth: 216.62 m
 Boring KC151#3
 Block 151, Keathley Canyon Area, Gulf of Mexico

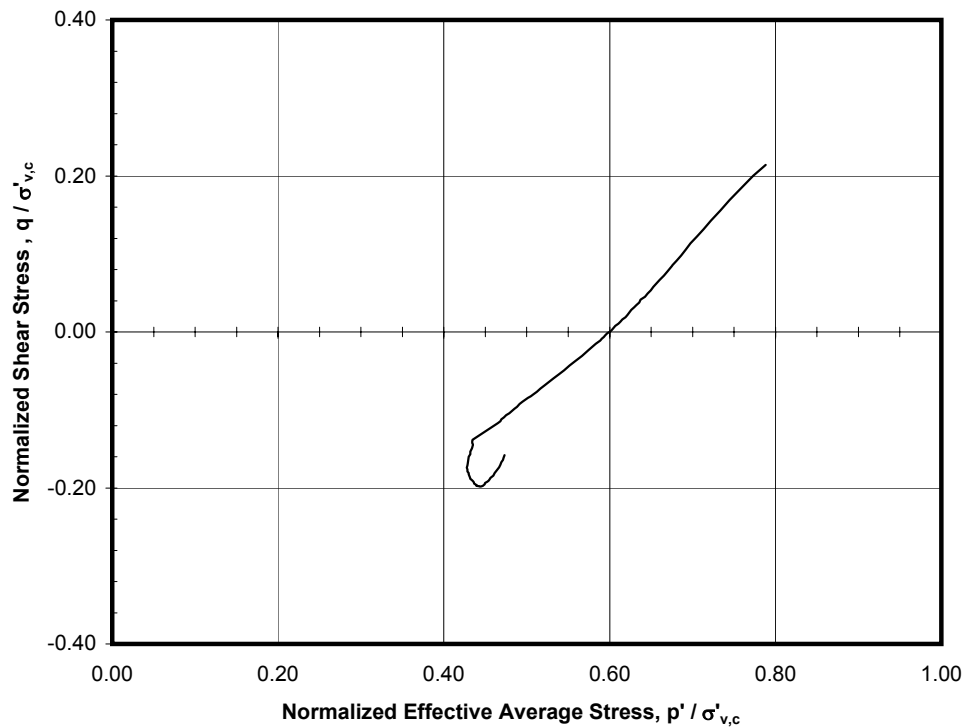
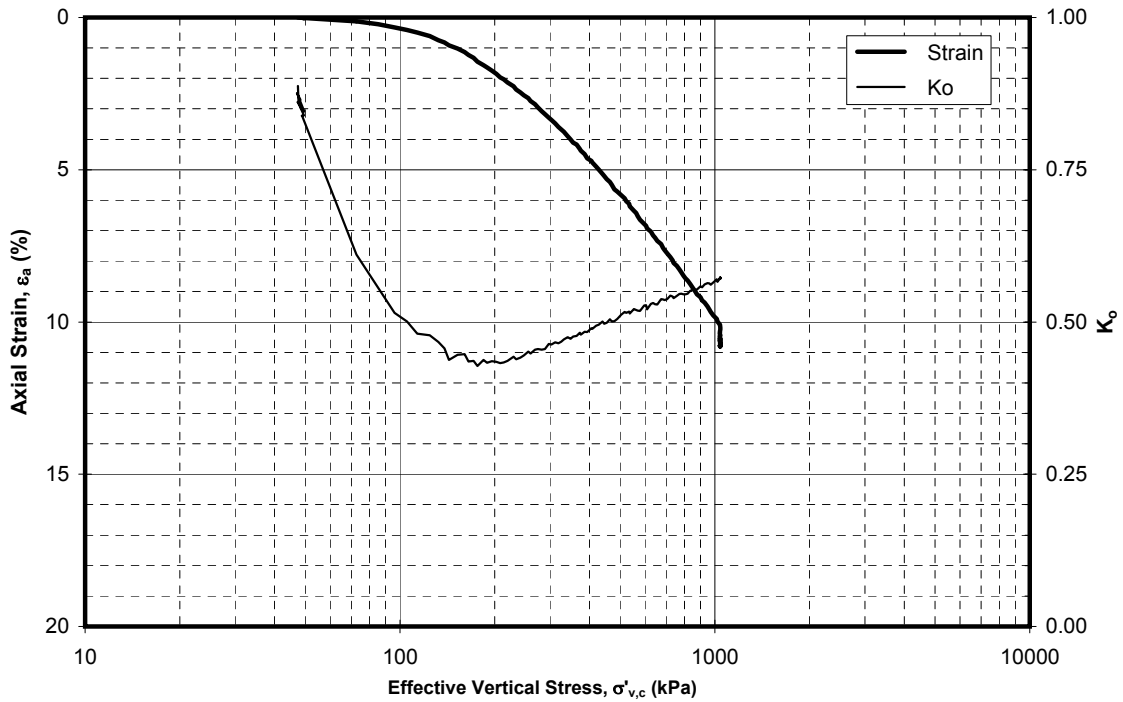

STATIC TRUEPATH TRIAXIAL TEST
 K_o Consolidated - OCR = 1 - Extension
 Sample: 24(8C-2)a - Depth: 216.62 m
 Boring KC151#3
 Block 151, Keathley Canyon Area, Gulf of Mexico

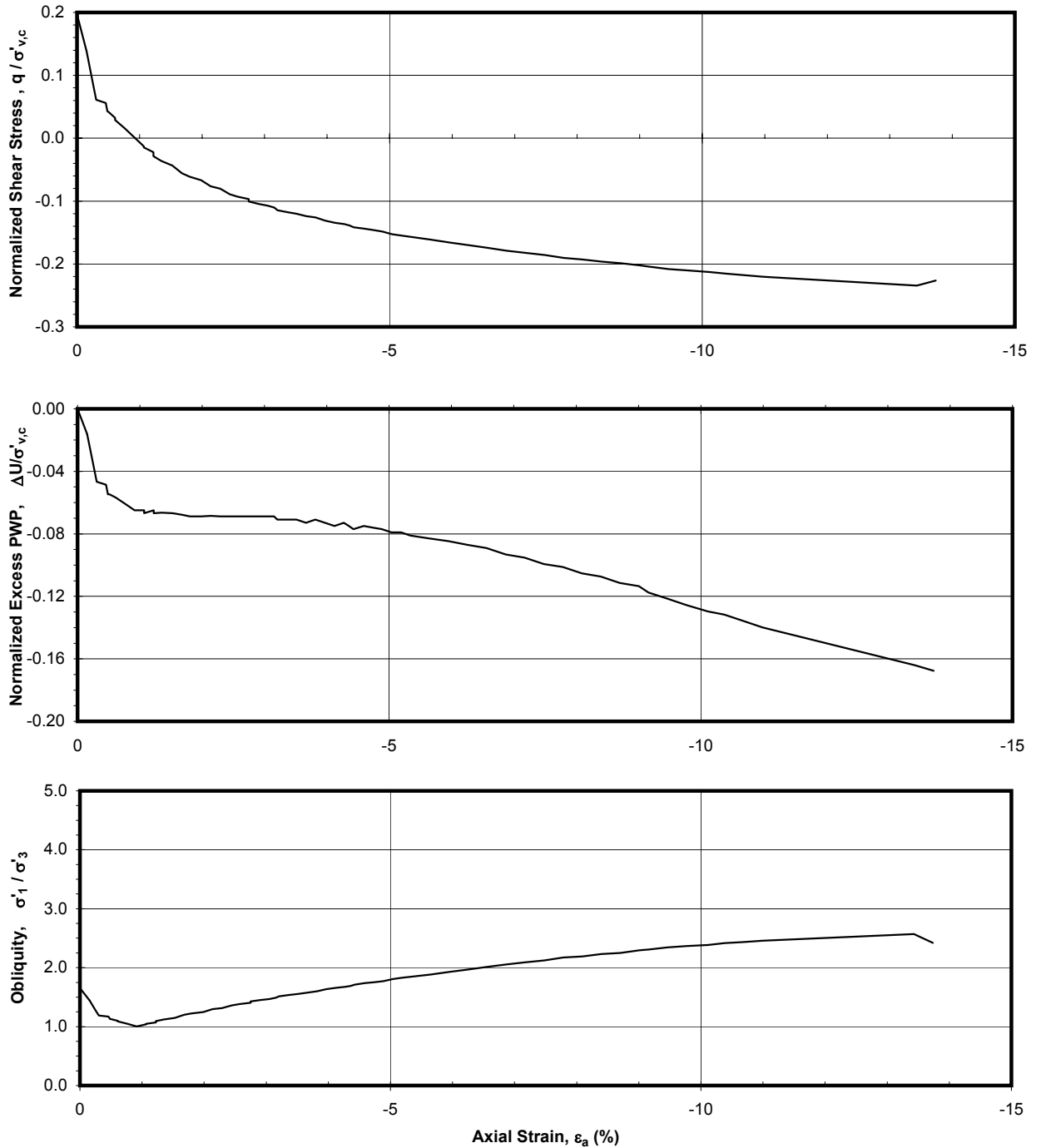

STATIC TRUEPATH TRIAXIAL TEST
 K₀ Consolidated - OCR = 1 - Extension
 Sample: 28(17H-3)a - Depth: 258.99 m
 Boring KC151#3
 Block 151, Keathley Canyon Area, Gulf of Mexico

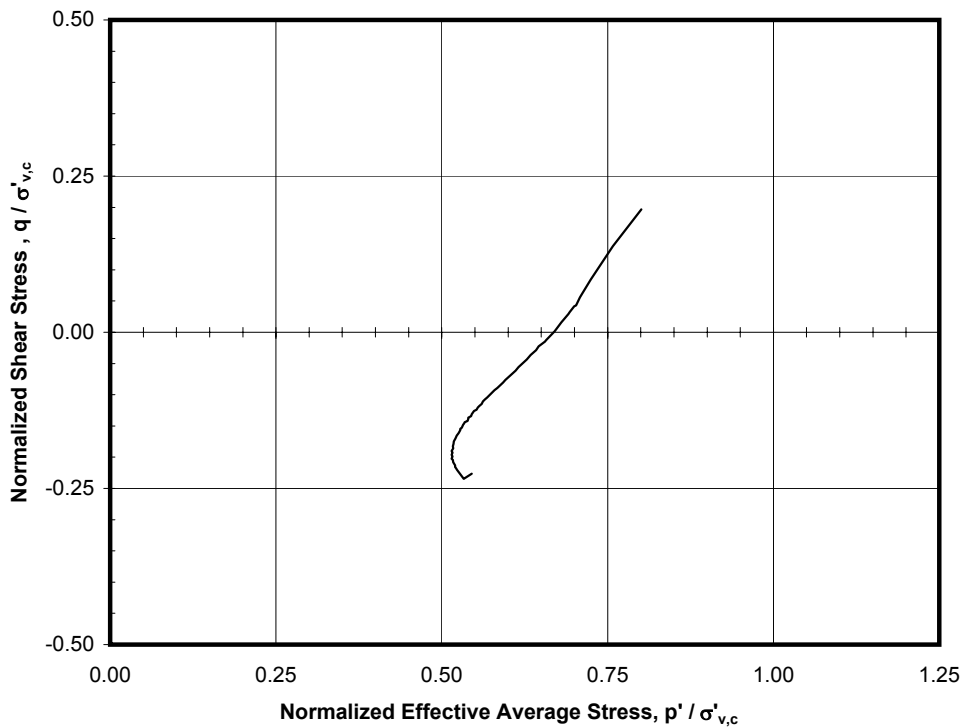
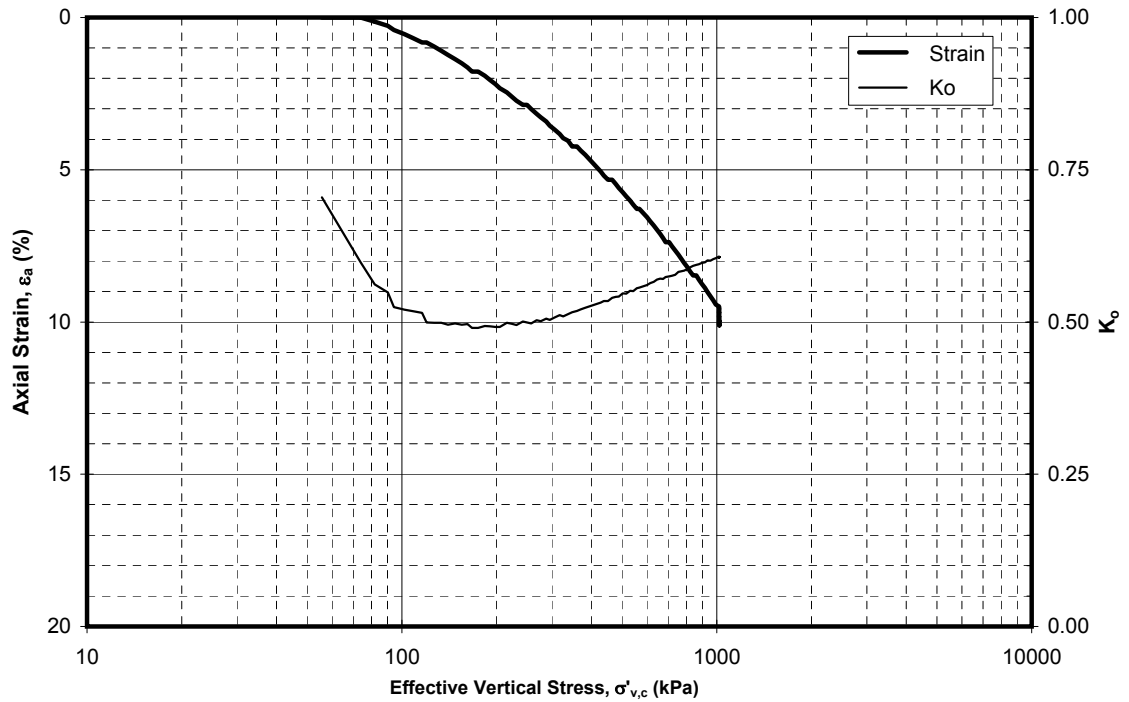

STATIC TRUETH PATH TRIAXIAL TEST
 K_o Consolidated - OCR = 1 - Extension
 Sample: 28(17H-3)a - Depth: 258.99 m
 Boring KC151#3
 Block 151, Keathley Canyon Area, Gulf of Mexico

Test No.	Specimen Information:			Nominal Diam. (mm)	Initial or Consol. Stage	Water Content, w Initial Test (%)	Total Unit Weight, γ_t Initial Test (kN/m ³)	Dry Unit Weight, γ_d Initial Test (kN/m ³)	Void Ratio, e Initial Test	Saturation, S Initial Test (%)	During Consolidation:		During Permeation:		Extrapolated $k_{20\text{ }^\circ\text{C}}$ (m/y) at initial e in vert. spec.	
	Boring No.	Specimen Orient.	Permeant								Isotropic Effective Stress, σ'_c (kPa)	Consol. Time, t_c (days)	Initial Gradient, i_o	Hydraulic Conductivity, $k_{20\text{ }^\circ\text{C}}$ (m/y)		
1V	Spec. ID	Depth (m)	Vertical Tap Water	64.97	Initial	29.3	17.6	13.6	0.982	81.9					Extrap- $k_{20\text{ }^\circ\text{C}}$	
	21(5H-7)d	44.11			1st	30.3	19.1	14.7	0.832	100.0	71.8	2.00	27.9	5.12E-03	= 3.40E-02	
					2nd	29.0	19.3	15.0	0.799	100.0	143.6	1.00	27.4	3.38E-03	at e = 0.982	
1H	Index Properties		Horizontal Tap Water	50.50	Initial	30.0	19.0	14.6	0.840	98.2					Extrap- $k_{20\text{ }^\circ\text{C}}$	
	USCS Symbol	G_s			1st	30.0	19.2	14.8	0.824	100.0	69.9	3.00	26.1	4.76E-03	= 2.53E-02	
		2.750			2nd	28.9	19.3	15.0	0.794	100.0	143.6	1.00	26.3	3.46E-03	at e = 0.982	
1R	CH		Remolded Tap Water	50.23	Initial	29.3	19.2	14.8	0.814	99.0					Extrap- $k_{20\text{ }^\circ\text{C}}$	
	LL	PI			1st	27.4	19.6	15.4	0.754	100.0	71.8	2.00	26.1	1.83E-03	= 6.15E-03	
	52	32			2nd	25.9	19.8	15.7	0.711	100.0	143.6	3.00	26.4	1.45E-03	at e = 0.982	
2V	Spec. ID	Depth (m)	Vertical Tap Water	65.30	Initial	31.3	18.5	14.1	0.916	93.9					Extrap- $k_{20\text{ }^\circ\text{C}}$	
	22(6C-1)a	100.78			1st	29.2	19.3	14.9	0.803	100.0	191.5	2.00	27.2	1.59E-02	= 5.87E-02	
					2nd	28.2	19.5	15.2	0.774	100.0	308.3	1.00	27.4	1.14E-02	at e = 0.916	
2H	Index Properties		Horizontal Tap Water	--	Initial	--	--	--	--	--					Extrap- $k_{20\text{ }^\circ\text{C}}$	
	USCS Symbol	G_s			1st	--	--	--	--	--	--	--	--	--	--	= --
		2.750			2nd	--	--	--	--	--	--	--	--	--	--	at e = 0.916
2R	CL		Remolded Tap Water	50.50	Initial	29.1	18.8	14.6	0.848	94.3					Extrap- $k_{20\text{ }^\circ\text{C}}$	
	LL	PI			1st	24.8	20.0	16.0	0.683	100.0	191.5	1.00	26.0	2.62E-03	= 5.13E-02	
	40	25			2nd	24.0	20.1	16.2	0.661	100.0	287.3	1.00	26.1	1.97E-03	at e = 0.916	
3V	Spec. ID	Depth (m)	Vertical Tap Water	37.93	Initial	30.3	18.9	14.5	0.856	97.2					Extrap- $k_{20\text{ }^\circ\text{C}}$	
	27(14C-2)c	243.66			1st	27.4	19.6	15.4	0.753	100.0	120.2	2.00	27.1	2.98E-03	= 3.88E-03	
					2nd	25.6	19.9	15.8	0.704	100.0	239.4	1.00	26.3	2.62E-03	at e = 0.856	
3H	Index Properties		Horizontal Tap Water	--	Initial	--	--	--	--	--					Extrap- $k_{20\text{ }^\circ\text{C}}$	
	USCS Symbol	G_s			1st	--	--	--	--	--	--	--	--	--	--	= --
		2.750			2nd	--	--	--	--	--	--	--	--	--	--	at e = 0.856
3R	CL		Remolded Tap Water	50.50	Initial	28.2	19.1	14.9	0.802	96.5					Extrap- $k_{20\text{ }^\circ\text{C}}$	
	LL	PI			1st	25.0	19.9	16.0	0.688	100.0	120.2	1.00	26.5	1.52E-03	= 6.67E-03	
	48	30			2nd	23.7	20.2	16.3	0.651	100.0	239.4	1.00	26.8	1.10E-03	at e = 0.856	

Note: Indicates value was copied from adjacent test specimen or assumed.

SUMMARY OF HYDRAULIC CONDUCTIVITY (PERMEABILITY) TEST SERIES: VHR

Boring KC151#3

Block 151, Keathley Canyon Area, Gulf of Mexico



Test No.		$C_k = \Delta e / \Delta \log(k)$	C_k / e_0	Extrap. $k_{20^\circ\text{C}}$ Ratios		Plate No.
				H / V	R / V	
1V	Fat clay (CH), olive gray	0.18	0.19	0.74	0.18	B-47
1H	Fat clay (CH), olive gray	0.22	0.22			
1R	Fat clay (CH), olive gray	0.43	0.44			
2V	Fat clay (CL), olive gray, with silt seams and parting	0.20	0.22	--	0.87	B-48
2H	--(Unable to test due to silt seams)	--	--			
2R	Fat clay (CL), olive gray, with silt seams and parting	0.18	0.20	--	1.72	B-49
3V	Fat clay (CL), olive gray, with silt seams (Horizontal)	0.89	1.04			
3H	--(Unable to test due to silt seams)	--	--			
3R	Fat clay (CL), olive gray, with silt seams and partings	0.26	0.31			

SUMMARY OF HYDRAULIC CONDUCTIVITY (PERMEABILITY) TEST SERIES: VHR

Boring KC151#3

Block 151, Keathley Canyon Area, Gulf of Mexico

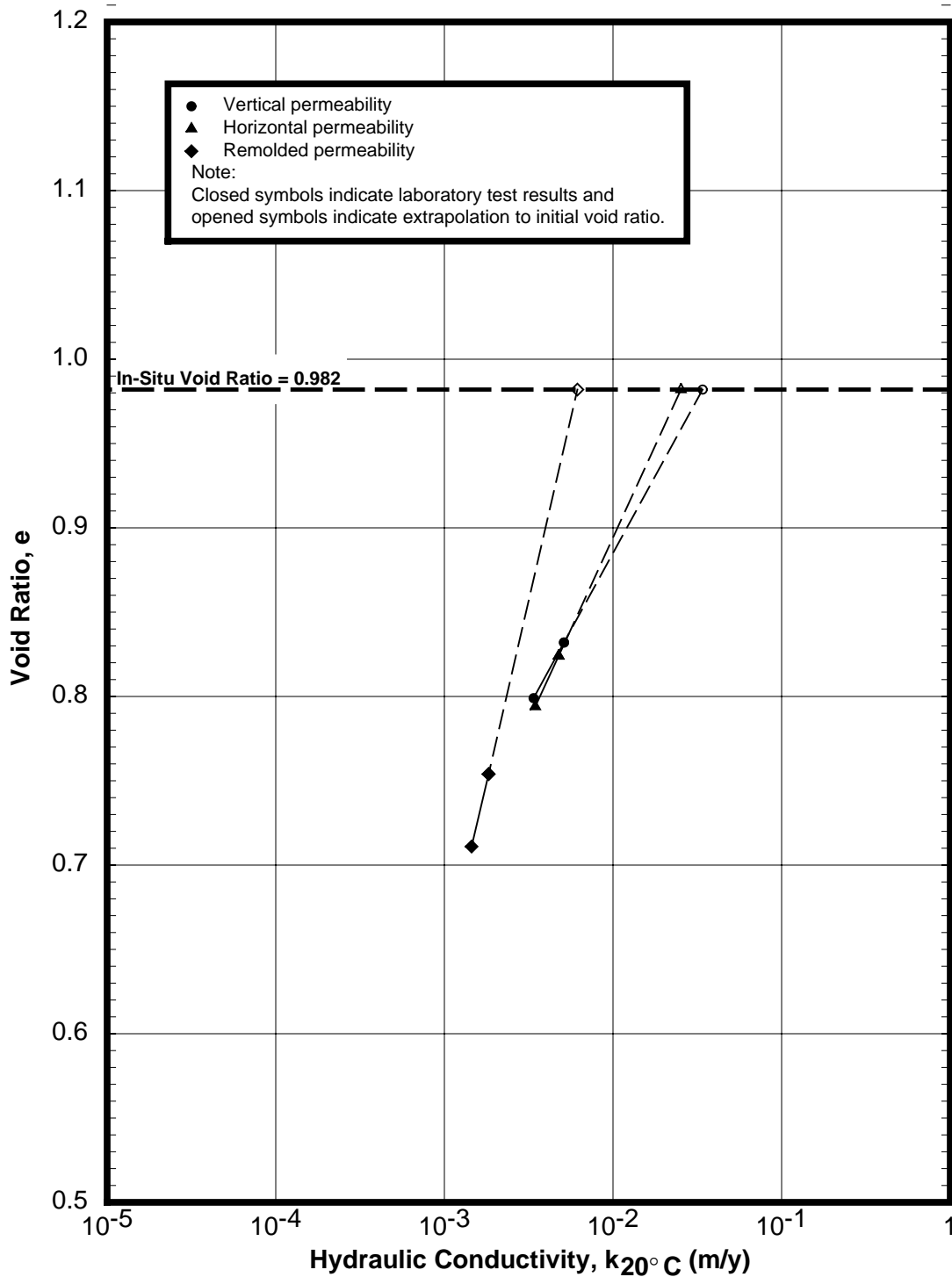

HYDRAULIC CONDUCTIVITY TEST RESULTS: PERMEABILITY TESTS

Boring KC151#3 - No. 21(5H-7)d - Depth 44.11 m
 CVX Gulf of Mexico Gas Hydrates JIP
 Block 151, Keathley Canyon Area, Gulf of Mexico

Date:

Drawn By:

Date:

Date:

Checked By:

Approved By:

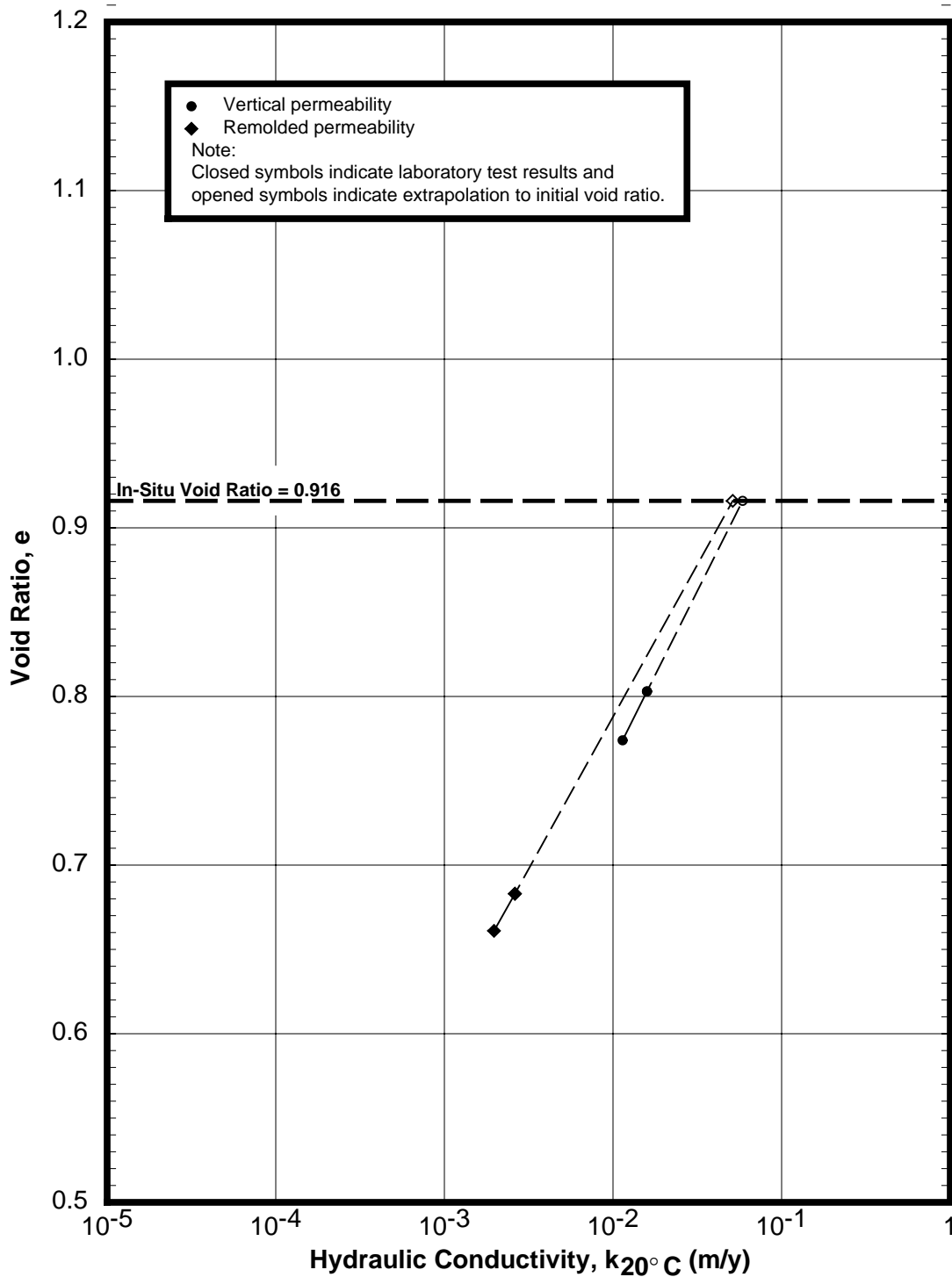

HYDRAULIC CONDUCTIVITY TEST RESULTS: PERMEABILITY TESTS

Boring KC151#3 - No. 22(6C-1)a - Depth 100.78 m
 CVX Gulf of Mexico Gas Hydrates JIP
 Block 151, Keathley Canyon Area, Gulf of Mexico

Date:

Drawn By:

Date:

Date:

Checked By:

Approved By:

Date:

Drawn By:

Date:

Checked By:

Date:

Approved By:

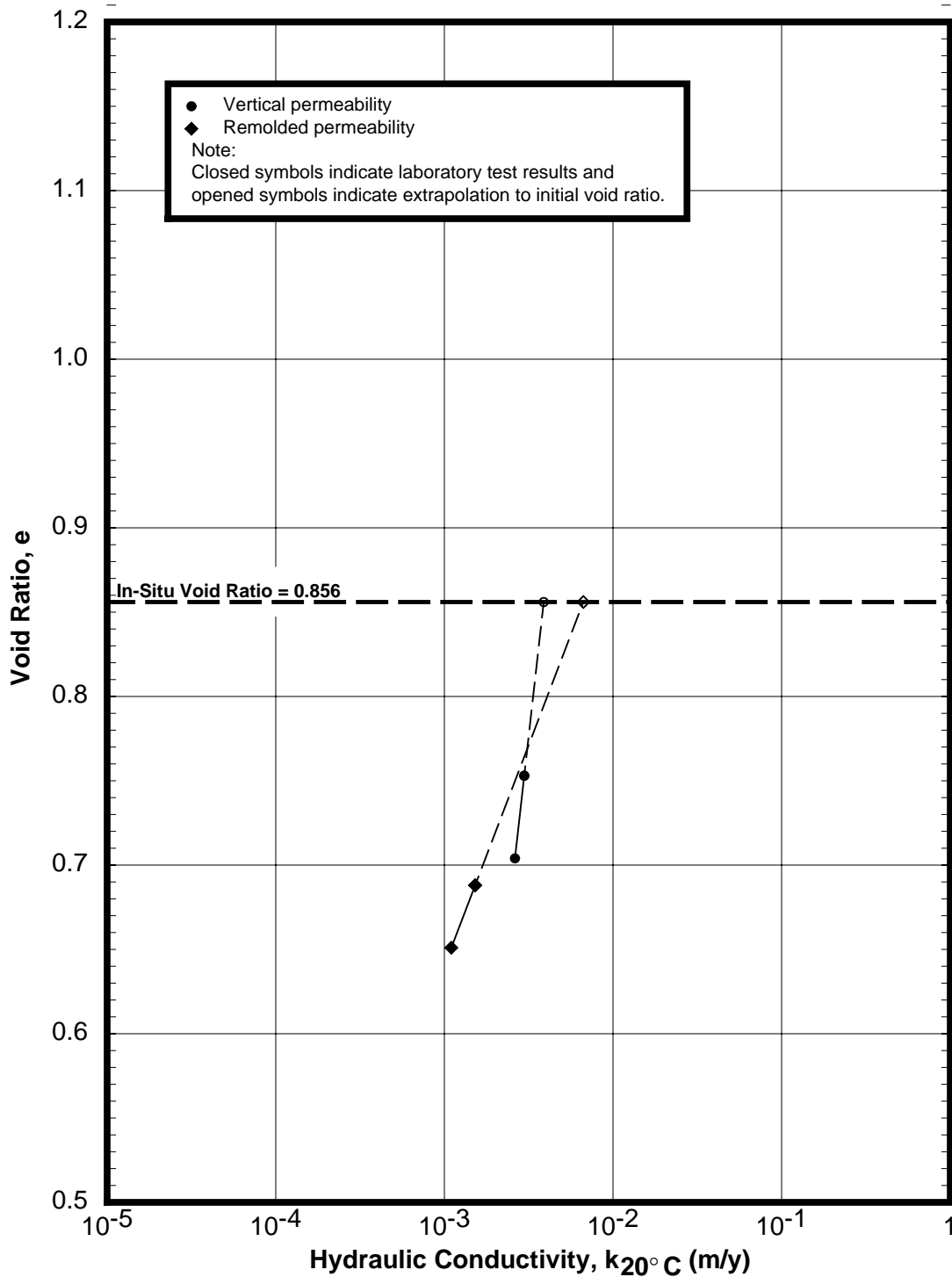

HYDRAULIC CONDUCTIVITY TEST RESULTS: PERMEABILITY TESTS

Boring KC151#3 - No. 27(14C-2)c - Depth 243.66 m

CVX Gulf of Mexico Gas Hydrates JIP

Block 151, Keathley Canyon Area, Gulf of Mexico

APPENDIX C
X-RAY RADIOGRAPHS

X-RAY RADIOGRAPHS CONTENTS

	<u>Page</u>
X-RAY RADIOGRAPHS.....	C-1
Introduction	C-1
X-Ray Radiography.....	C-1

ILLUSTRATIONS

	<u>Plate</u>
X-Ray Photograph of Selected FHPC and FC Samples, Boring KC151#3,	
Sample No. 20 (5H-6) – Depth: 42.2 – 42.4mbsf (138.4 – 139.1 ft).....	C-1
Sample No. 21 (5H-7) – Depth: 44.0 – 44.2mbsf (144.3 – 145.0 ft).....	C-2
Sample No. 22 (6C-1) – Depth: 100.6 – 100.8mbsf (330.1 – 330.8 ft).....	C-3
Sample No. 23 (7C-1) – Depth: 210.0 – 210.2mbsf (689.0 – 689.7 ft).....	C-4
Sample No. 24 (8C-2) – Depth: 216.4 – 216.6mbsf (710.0 – 710.7 ft).....	C-5
Sample No. 25 (10C-2) – Depth: 224.1 – 224.3mbsf (735.3 – 735.9 ft).....	C-6
Sample No. 26 (12C-1) – Depth: 230.8 – 231.0mbsf (757.1 – 757.8 ft).....	C-7
Sample No. 27 (14C-2) – Depth: 243.6 – 243.8mbsf (799.1 – 799.7 ft).....	C-8
Sample No. 28 (17H-3) – Depth: 258.8 – 259.0mbsf (849.2 – 849.7 ft).....	C-9
Sample No. 29 (19H-4) – Depth: 278.4 – 278.6mbsf (913.3 – 914.1 ft).....	C-10
Sample No. 30 (20H-4) – Depth: 295.9 – 296.2mbsf (970.8 – 971.8 ft).....	C-11
Sample No. 31 (21H-2) – Depth: 313.0 – 313.2mbsf (1,026.9 – 1,027.6 ft).....	C-12
Sample No. 32 (24C-2) – Depth: 370.4 – 370.6mbsf (1,215.3 – 1,215.9 ft).....	C-13

X-RAY RADIOGRAPHS

Introduction

Selected FHPC and FC liner samples obtained in the field were subjected to X-Rays to determine the quality of soil sample within the tube for evaluation and were used for the purpose of assigning advanced static and cyclic laboratory tests.

X-Ray Radiography

X-ray radiographs were performed on six (6) selected FHPC liner samples and seven (7) FC liner samples recovered from **Boring KC151#3**. These were the only liner enclosed samples available to FMMG for this kind of investigation due to the limited numbers of samples made available for this laboratory program by the scientific party. Copies of the digital photographs of these X-ray radiographs are presented on Plates [C-1](#) through [C-13](#).

X-ray radiography provides a qualitative measure of the internal structure of the soil sampled in the plastic liners. The display of varying shades of gray, resulting from variations in the ability of the X-rays to penetrate matter, enables the evaluation/determination of the following:

- Sample quality as noted by signs of voids, drilling wash, unusual changes in bedding planes or layering, etc.;
- Presence of intrusions in the sample, such as shells and/or calcareous nodules; and
- Presence of naturally occurring fissures, shear planes, bedding planes, layering, gravels, and silt seams.

Review of the thirteen provides us with a great deal of information for this job. A distinct difference becomes apparent when comparing x-rays of FHPC samples with those from FC samples. While the FHPC samples generally shows significant amounts of voids due to sample expansion, FC samples tend to display a very homogenous structure suggesting better sample quality. This is, though, misleading as the difference tool mechanics need to be considered when evaluating the x-rays. FHPC samples, as described in the corresponding section ([Appendix A](#)) are taken by shooting the core barrel into the formation using hydraulic energy stored inside the drill string, while FC samples are taken by a hydraulic flow-driven percussion sampler. This percussion mechanism is believed to generate small paths between sample and liner that allow any overpressure resulting from the recovery of the samples from great depths to escape and, hence, minimize sample expansion. Laboratory testing performed on FC samples, however, do not show any different characteristics than those tests performed on FHPC samples and therefore, conclusions as to sample quality can not be drawn simply from a review of those x-rays in this particular case.

APPENDIX C
ILLUSTRATIONS

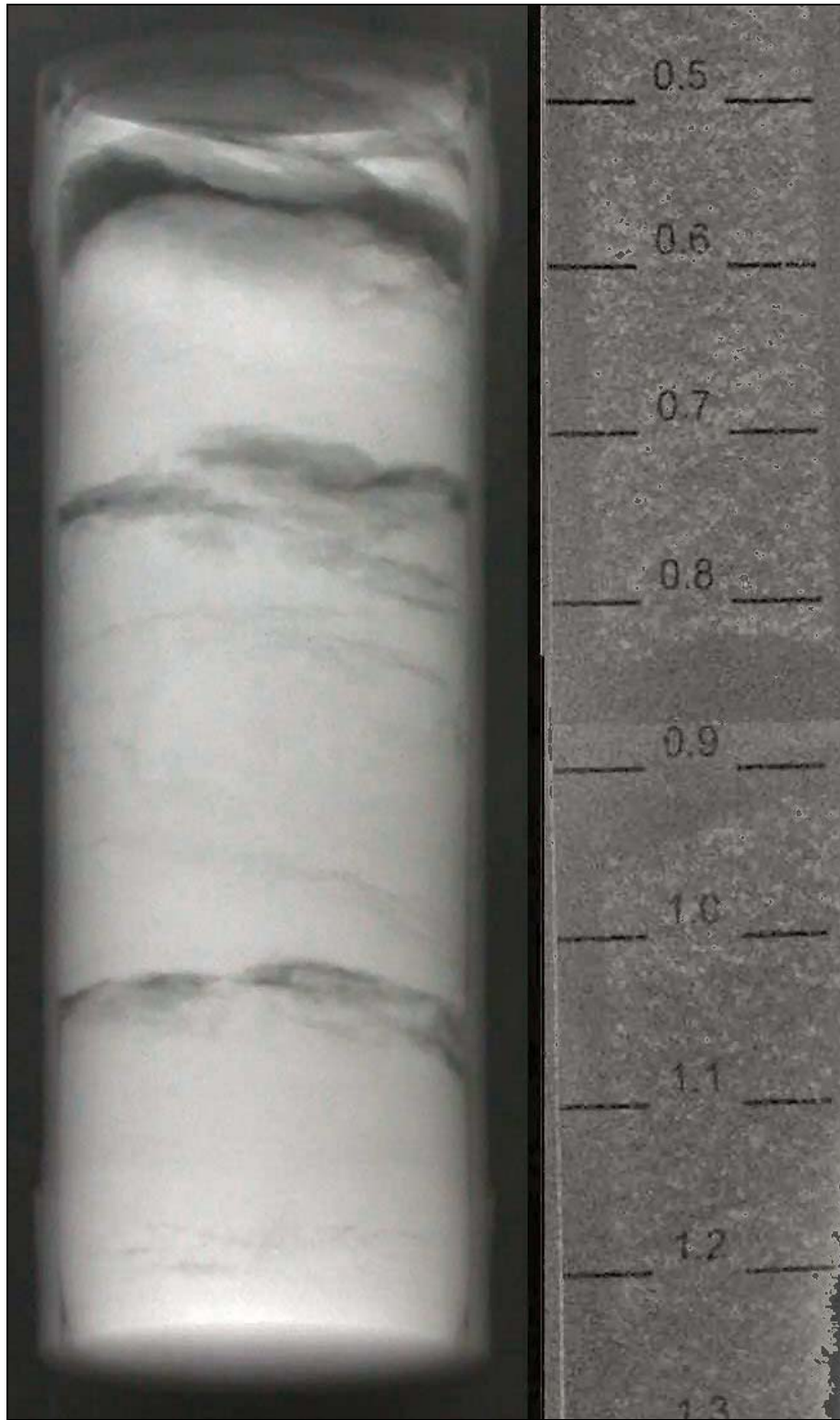

X-RAY RADIOGRAPHS OF SELECTED FHPC AND FC SAMPLES

Sample No. 20 (5H-6) – Depth: 42.2 – 42.4mbsf (138.4 – 139.1 ft)
CVX GoM Gas Hydrates JIP, Boring KC151#3
Block 151, Atwater Valley Area, Gulf of Mexico

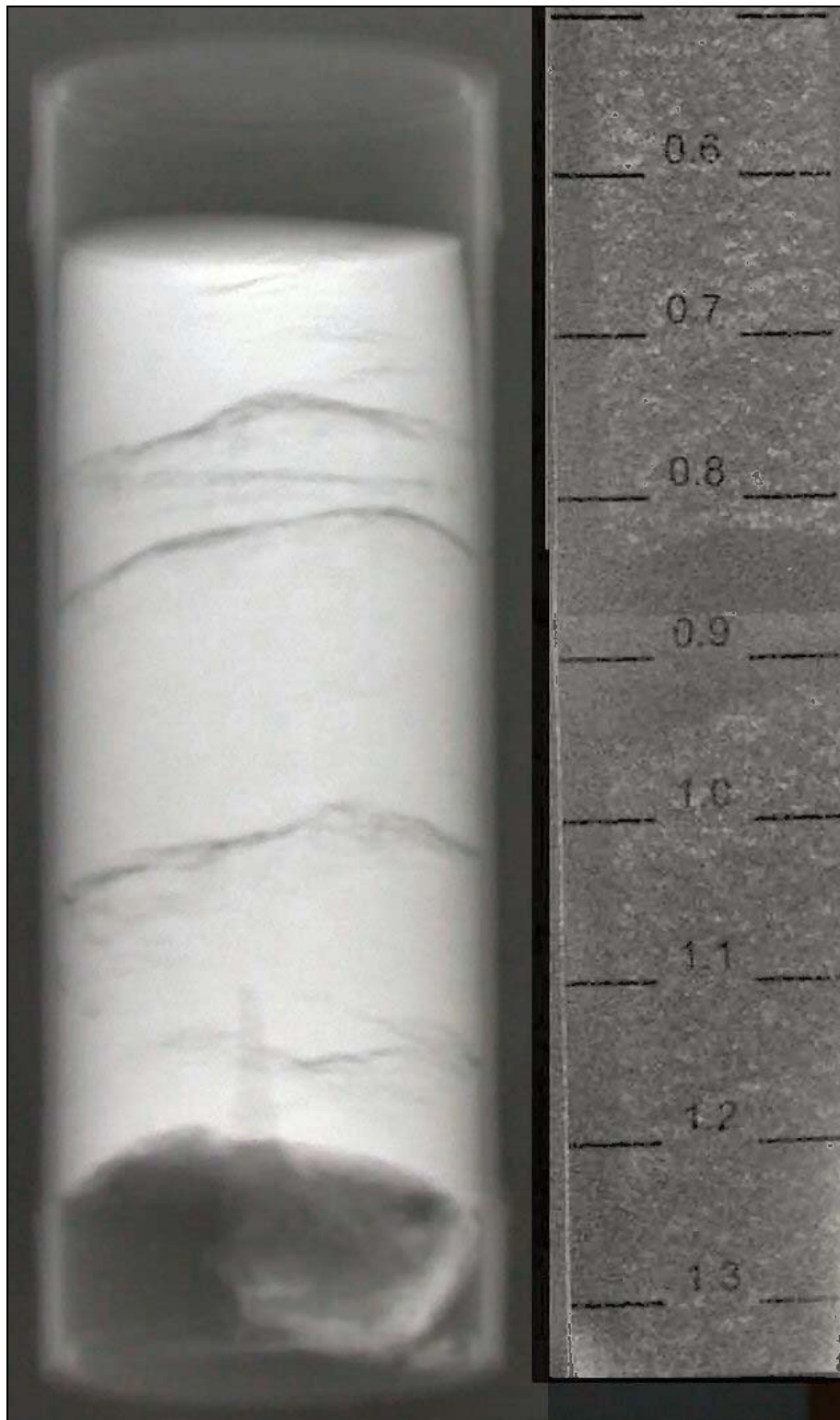

X-RAY RADIOGRAPHS OF SELECTED FHPC AND FC SAMPLES

Sample No. 21 (5H-7) – Depth: 44.0 – 44.2mbsf (144.3 – 145.0 ft)
CVX GoM Gas Hydrates JIP, Boring KC151#3
Block 151, Atwater Valley Area, Gulf of Mexico



X-RAY RADIOGRAPHS OF SELECTED FHPC AND FC SAMPLES

Sample No. 22 (6C-1) – Depth: 100.6 – 100.8mbsf (330.1 – 330.8 ft)
CVX GoM Gas Hydrates JIP, Boring KC151#3
Block 151, Atwater Valley Area, Gulf of Mexico

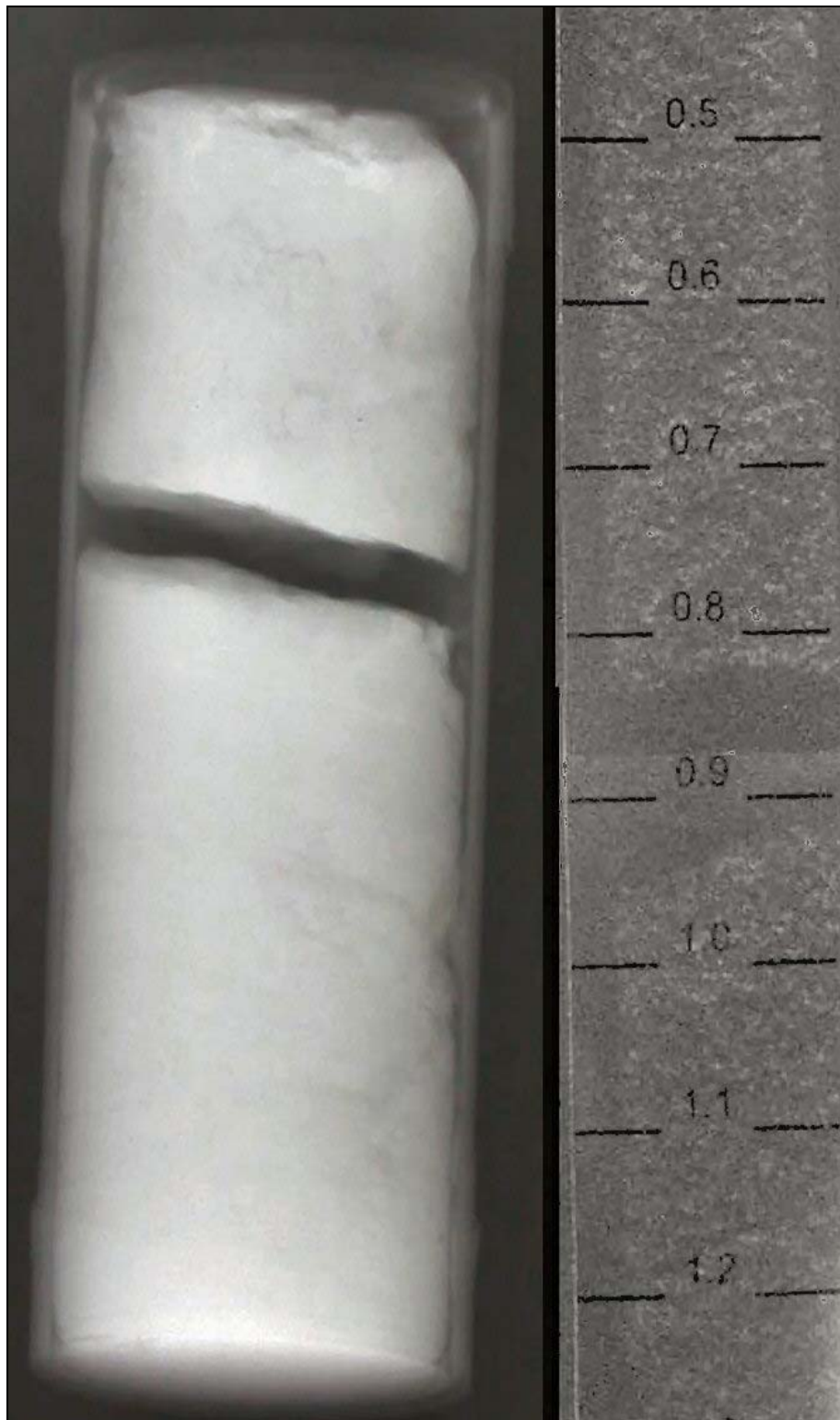

X-RAY RADIOGRAPHS OF SELECTED FHPC AND FC SAMPLES

Sample No. 23 (7C-1) – Depth: 210.0 – 210.2mbsf (689.0 – 689.7 ft)
CVX GoM Gas Hydrates JIP, Boring KC151#3
Block 151, Atwater Valley Area, Gulf of Mexico

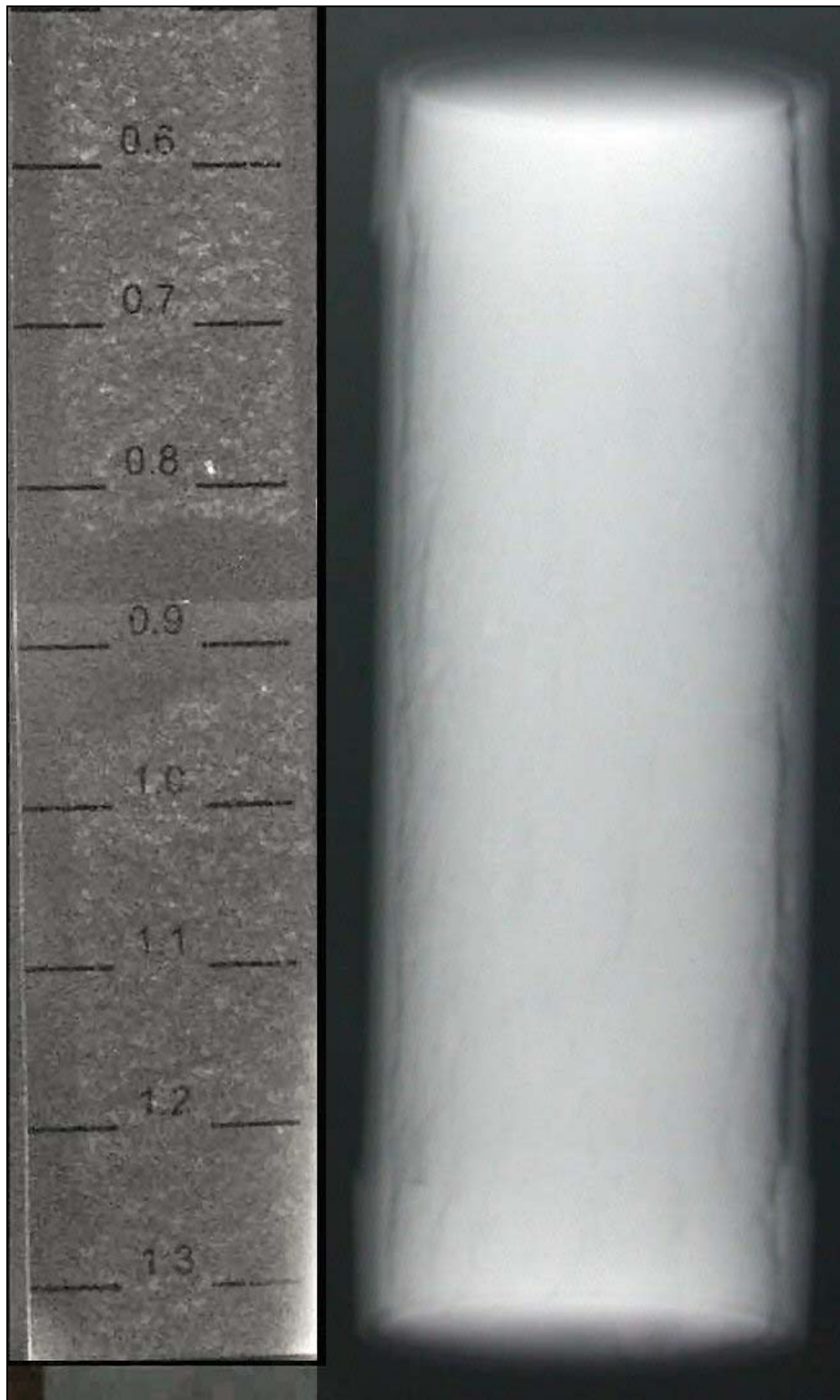

X-RAY RADIOGRAPHS OF SELECTED FHPC AND FC SAMPLES

Sample No. 24 (8C-2) – Depth: 216.4 – 216.6mbsf (710.0 – 710.7 ft)
CVX GoM Gas Hydrates JIP, Boring KC151#3
Block 151, Atwater Valley Area, Gulf of Mexico



X-RAY RADIOGRAPHS OF SELECTED FHPC AND FC SAMPLES

Sample No. 25 (10C-2) – Depth: 224.1 – 224.3mbsf (735.3 – 735.9 ft)
CVX GoM Gas Hydrates JIP, Boring KC151#3
Block 151, Atwater Valley Area, Gulf of Mexico

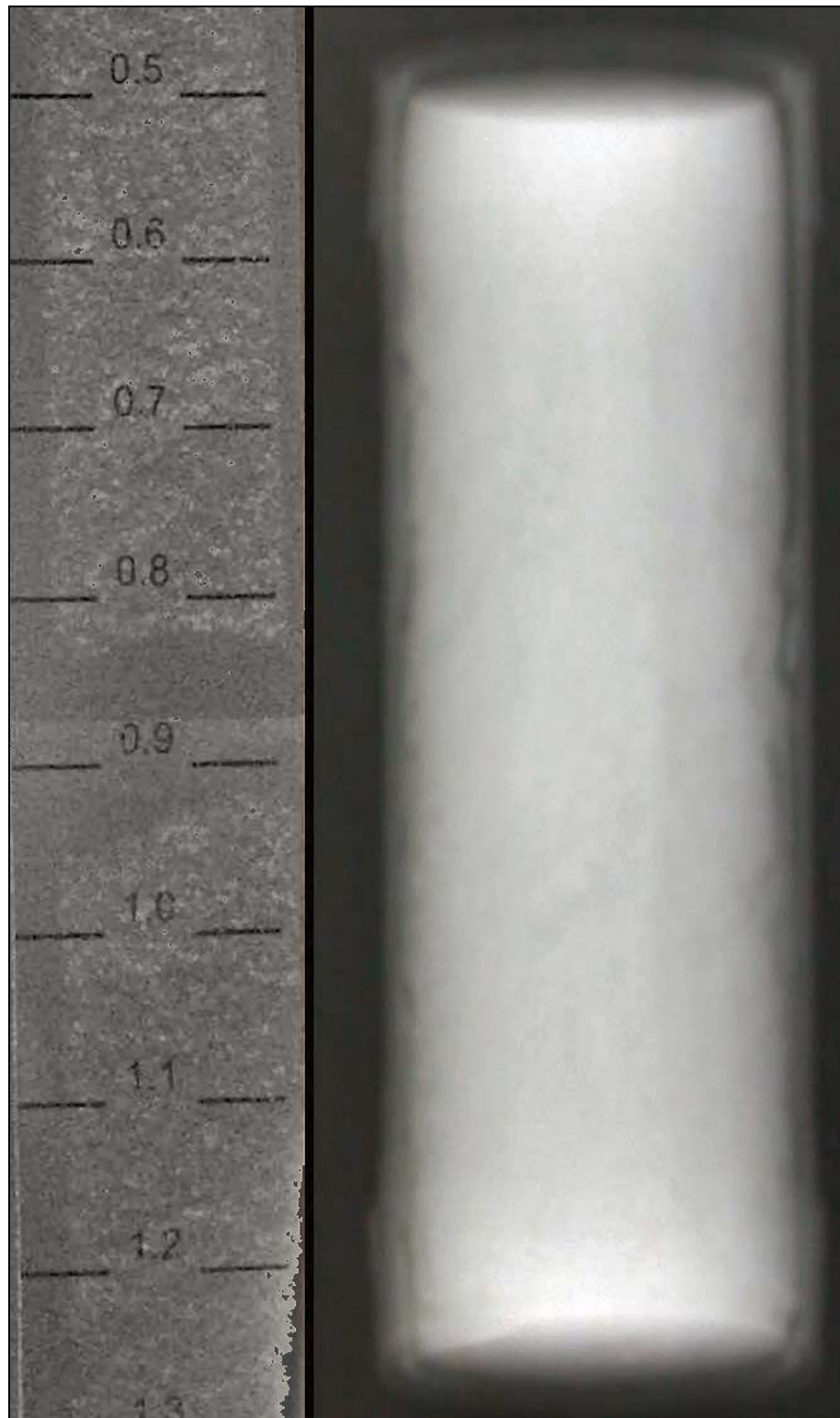

X-RAY RADIOGRAPHS OF SELECTED FHPC AND FC SAMPLES

Sample No. 26 (12C-1) – Depth: 230.8 – 231.0mbsf (757.1 – 757.8 ft)
CVX GoM Gas Hydrates JIP, Boring KC151#3
Block 151, Atwater Valley Area, Gulf of Mexico

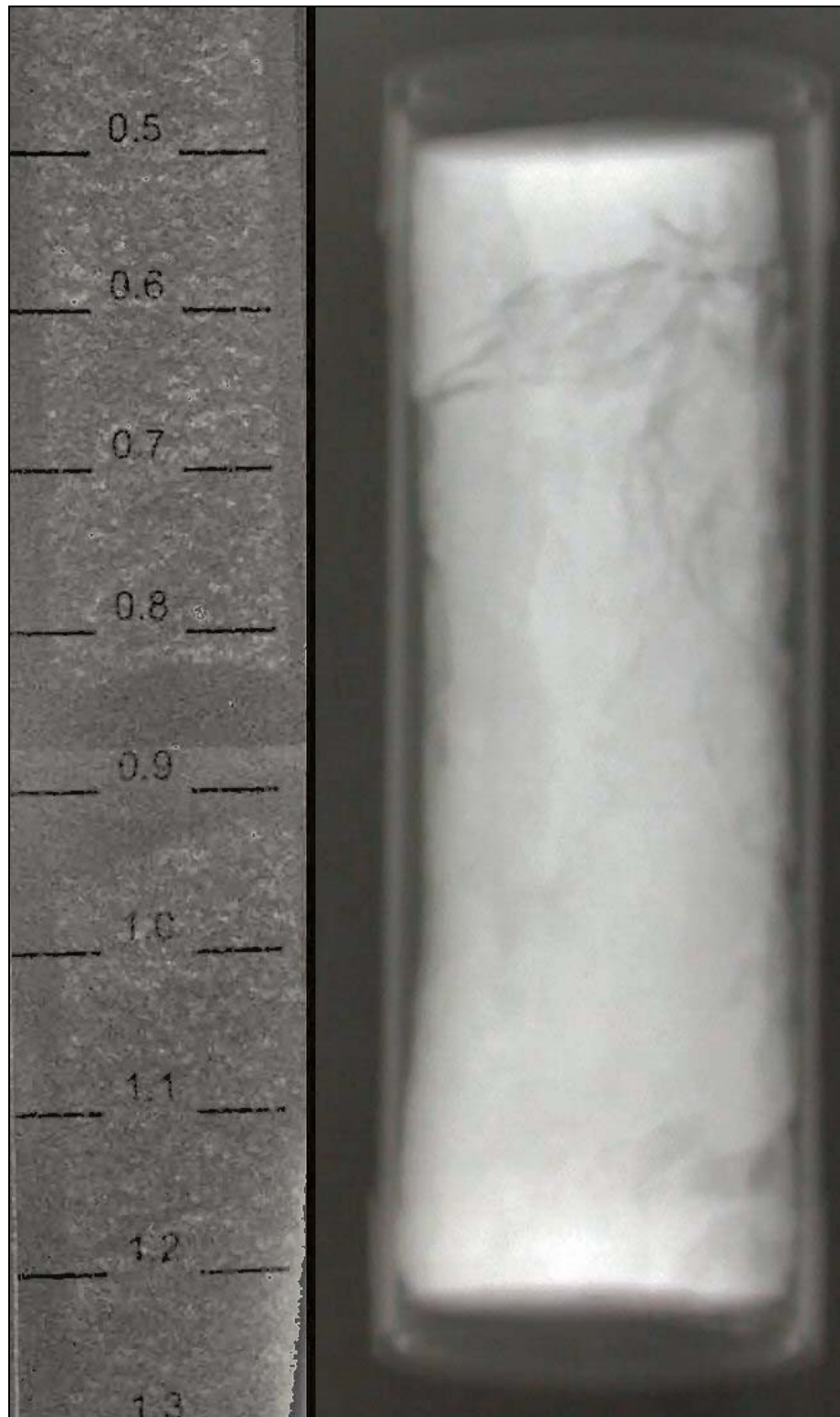

X-RAY RADIOGRAPHS OF SELECTED FHPC AND FC SAMPLES

Sample No. 27 (14C-2) – Depth: 243.6 – 243.8.0mbsf (799.1 – 799.7 ft)
CVX GoM Gas Hydrates JIP, Boring KC151#3
Block 151, Atwater Valley Area, Gulf of Mexico

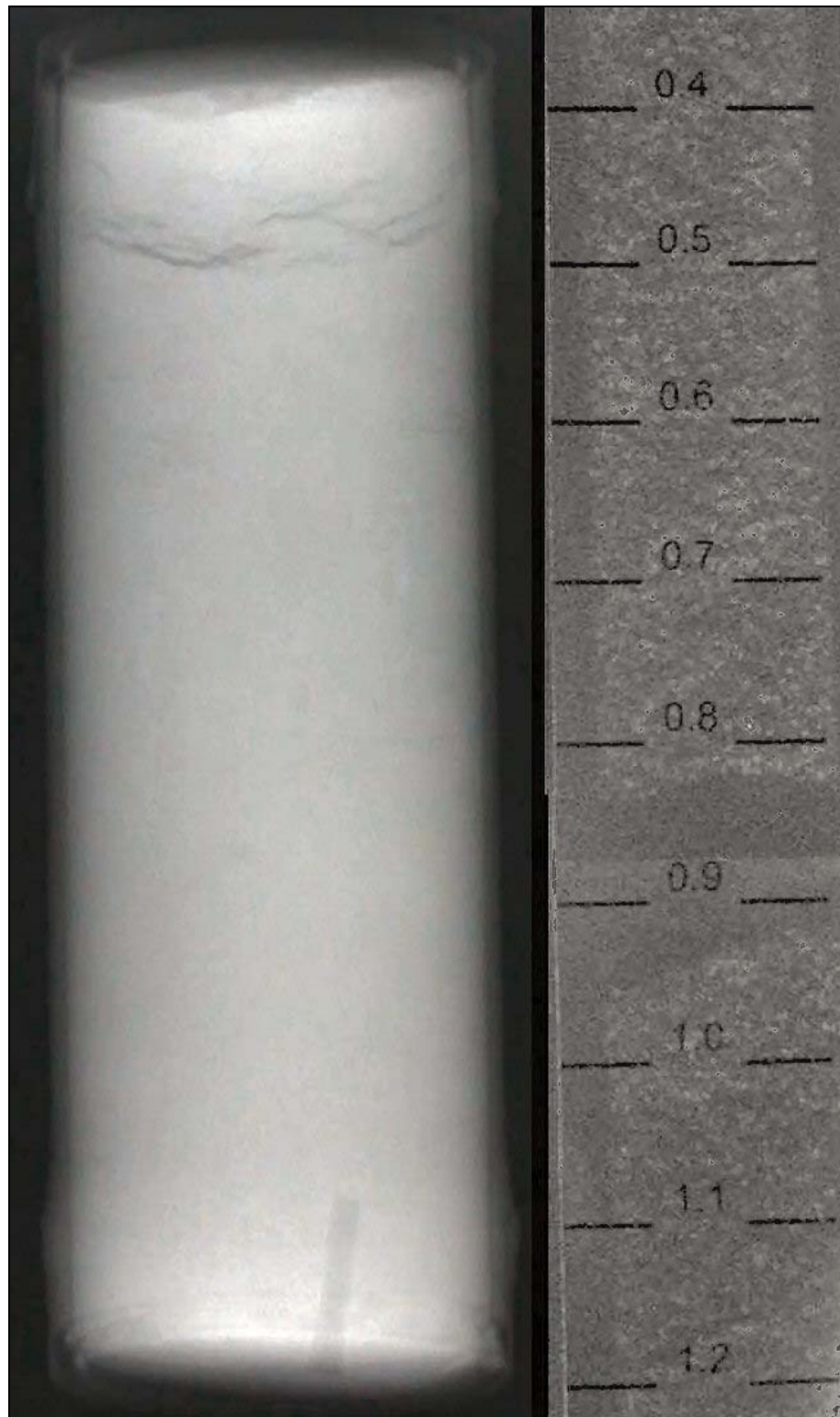

X-RAY RADIOGRAPHS OF SELECTED FHPC AND FC SAMPLES

Sample No. 28 (17H-3) – Depth: 258.8 – 259.0mbsf (849.2 – 849.7 ft)
CVX GoM Gas Hydrates JIP, Boring KC151#3
Block 151, Atwater Valley Area, Gulf of Mexico

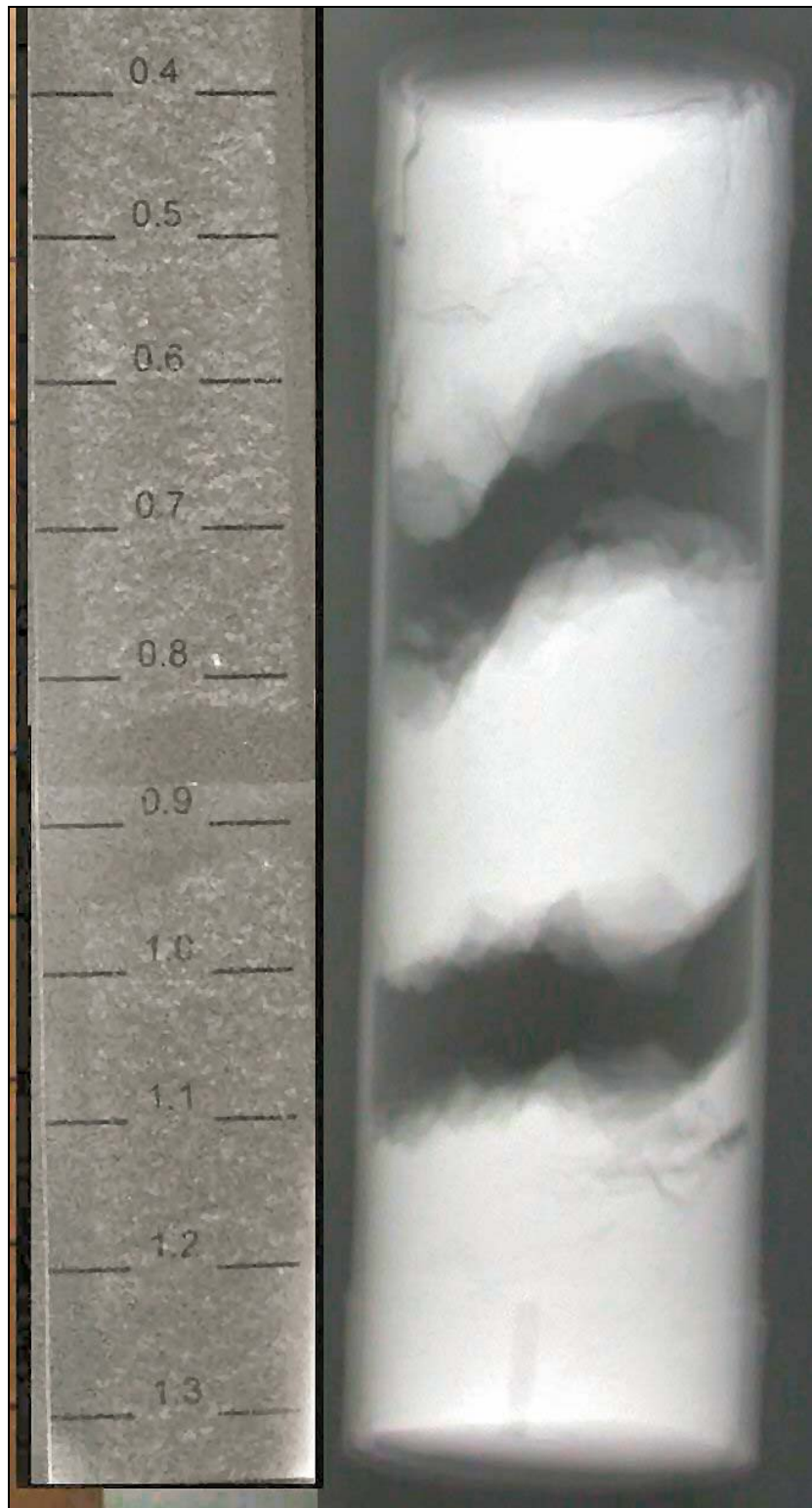

X-RAY RADIOGRAPHS OF SELECTED FHPC AND FC SAMPLES

Sample No. 29 (19H-4) – Depth: 278.4 – 278.6mbsf (913.3 – 914.1 ft)
CVX GoM Gas Hydrates JIP, Boring KC151#3
Block 151, Atwater Valley Area, Gulf of Mexico

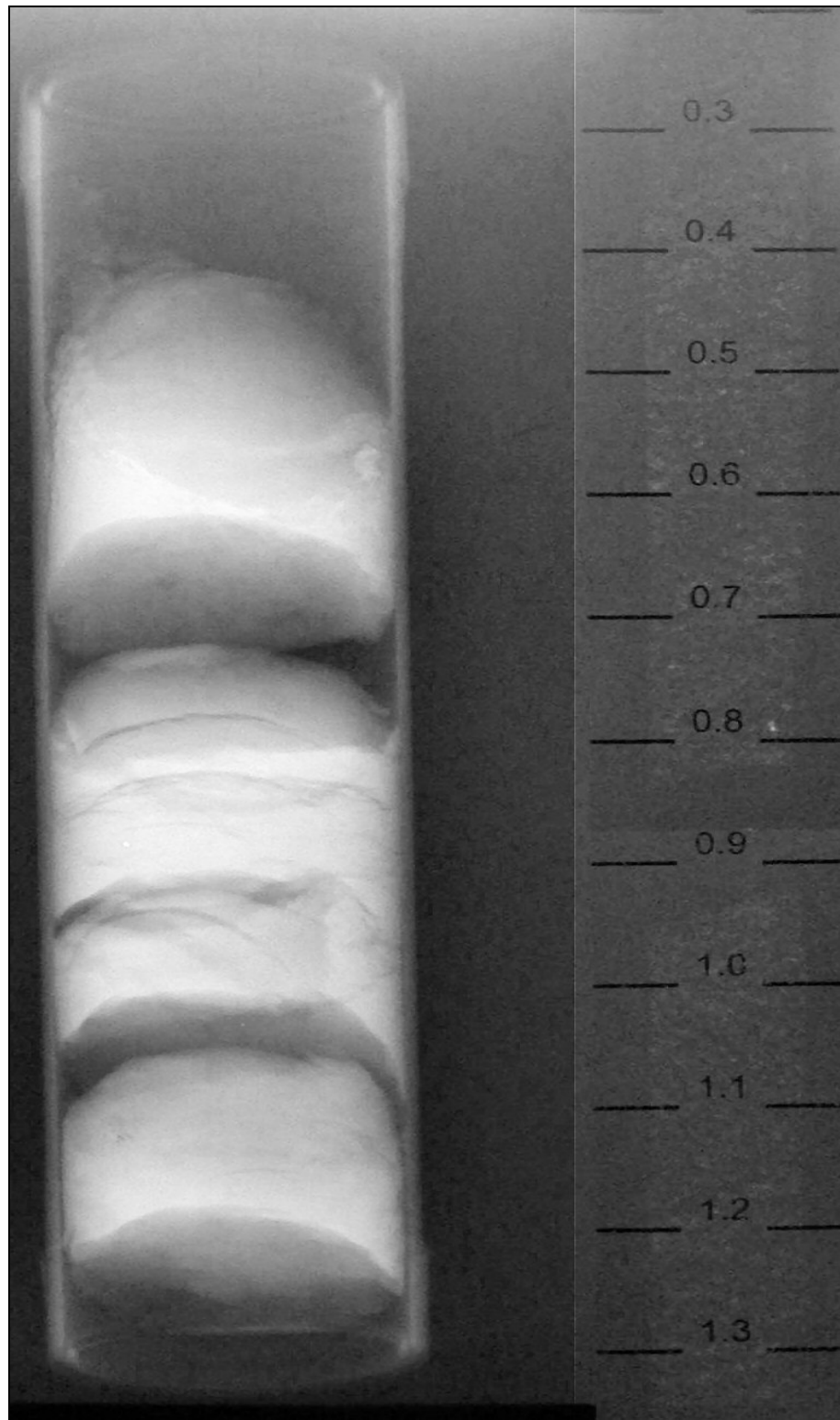

X-RAY RADIOGRAPHS OF SELECTED FHPC AND FC SAMPLES

Sample No. 30 (20H-4) – Depth: 295.9 – 296.2mbsf (970.8 – 971.8 ft)
CVX GoM Gas Hydrates JIP, Boring KC151#3
Block 151, Atwater Valley Area, Gulf of Mexico



X-RAY RADIOGRAPHS OF SELECTED FHPC AND FC SAMPLES

Sample No. 31 (21H-2) – Depth: 313.0 – 313.2mbsf (1026.9 – 1027.6 ft)
CVX GoM Gas Hydrates JIP, Boring KC151#3
Block 151, Atwater Valley Area, Gulf of Mexico

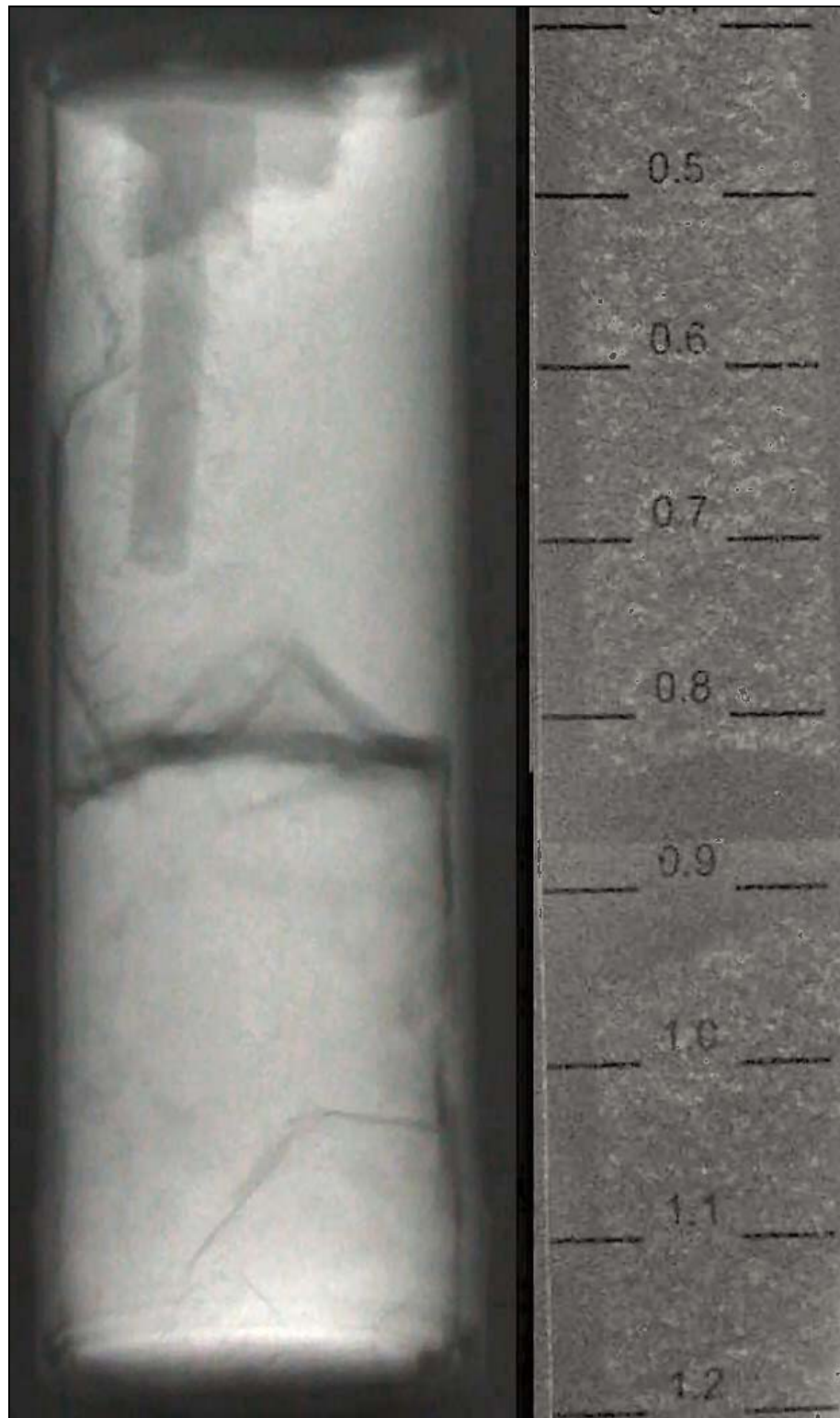

X-RAY RADIOGRAPHS OF SELECTED FHPC AND FC SAMPLES

Sample No. 32 (24C-2) – Depth: 370.4 – 370.6mbsf (1215.3 – 1215.9 ft)
CVX GoM Gas Hydrates JIP, Boring KC151#3
Block 151, Atwater Valley Area, Gulf of Mexico

APPENDIX D
POSITIONING REPORT by FUGRO CHANCE, INC.



SOIL BORING SURVEY REPORT

OCS-G-24203 AND 25212

ATWATER VALLEY AREA

BLOCK 13 AND 14

Job No. 05-7251

PREPARED BY:
Fugro Chance Inc.
6100 Hillcroft
Houston TX 77081
713-346-3700

PREPARED FOR:
**Fugro-McClelland Marine
Geosciences, Inc.**
6100 Hillcroft
Houston TX 77081

**ATWATER VALLEY 13 AND 14 (OCS-G-24203 AND 25212)
05-7251: Summary of Coordinates**

Location	Proposed Location		Surveyed Location		Distance to Proposed	Azimuth to Proposed	Survey Date
	Northing	Easting	Northing	Easting			
AT1 Surface	10,145,035.55'	904,181.44'	10,145,063.01'	904,155.06'	38.08'	136.15°	04/22/05
AT1 Subsurface	10,145,035.55'	904,181.44'	10,145,043.93'	904,202.80'	22.95'	248.58°	04/22/05
AT2 Surface	10,148,521.86'	901,438.19'	10,148,542.66'	901,412.89'	32.75'	129.42°	04/19/05
AT2 Subsurface	10,148,521.86'	901,438.19'	10,148,522.91'	901,439.08'	1.38'	220.29°	04/19/05
AT2-2 Surface	10,148,521.86'	901,438.19'	10,148,573.57'	901,434.43'	51.85'	175.86°	04/26/05
AT2-2 (Subsurface)	10,148,521.86'	901,438.19'	10,148,553.64'	901,464.60'	41.32'	219.73°	04/26/05
ATM1 (AT14a) Surface	10,144,646.35'	904,551.77'	10,144,646.92'	904,510.95'	40.82'	90.80°	05/03/05
ATM1 (AT14a) (Subsurface)	10,144,646.35'	904,551.77'	10,144,643.27'	904,552.60'	3.19'	344.92°	05/03/05
ATM4 (AT5) Surface	10,144,646.25'	904,470.29'	10,144,658.07'	904,438.46'	33.96'	110.36°	05/04/05
ATM4 (AT5) Subsurface	10,144,646.25'	904,470.29'	10,144,645.33'	904,479.25'	9.00'	275.89°	05/05/05

All co-ordinates are in US Survey Feet, NAD 27, UTM 16.

Surveyed coordinates transformed from NAD83 (GPS DATUM) to NAD27 (CHART DATUM) using NADCON Version 2.1.

Surface Coordinates represent the position of the soil borings obtained using Starfix DGPS surface positioning.

Subsurface Coordinates represent the position of the soil borings obtained using Starfix DGPS and Ultra Short Baseline (USBL) acoustic positioning.



SOIL BORING SURVEY REPORT

KEATHLEY CANYON AREA

BLOCK 151

Job No. 05-7251

PREPARED BY:
Fugro Chance Inc.
6100 Hillcroft
Houston TX 77081
713-346-3700

PREPARED FOR:
**Fugro-McClelland Marine
Geosciences, Inc.**
6100 Hillcroft
Houston TX 77081

KEATHLEY CANYON 151
05-7251: Summary of Coordinates

Location	Proposed Location		Surveyed Location		Distance to Proposed	Azimuth to Proposed	Survey Date
	Northing	Easting	Northing	Easting			
KC1 Surface	9,733,112.41'	1,644,827.03'	9,733,120.38'	1,644,816.71'	13.04'	127.68°	05/08/05
KC1 Subsurface	9,733,112.41'	1,644,827.03'	9,733,119.97'	1,644,815.89'	13.46'	124.16°	05/08/05
KC1B Surface	9,733,112.41'	1,644,827.03'	9,733,102.19'	1,644,780.83'	47.32'	47.32°	05/11/05
KC1B Subsurface	9,733,112.41'	1,644,827.03'	9,733,120.95'	1,644,769.01'	58.65'	98.37°	05/11/05

All co-ordinates are in US Survey Feet, NAD 27, UTM 15.

Surveyed coordinates transformed from NAD83 (GPS DATUM) to NAD27 (CHART DATUM) using NADCON Version 2.1.

Surface Coordinates represent the position of the soil borings obtained using Starfix DGPS surface positioning.

Subsurface Coordinates represent the position of the soil borings obtained using Starfix DGPS and Ultra Short Baseline (USBL) acoustic positioning.