

# Materials and Approaches for the Mitigation of SOFC Cathode Degradation in SOFC Power Systems

**Prabhakar Singh**

**Department of Materials Science and Engineering  
Center for Clean Energy Engineering, University of Connecticut, CT**

**WORK PERFORMED UNDER AGREEMENT DE-FE 0023385 and 0027894**

**18<sup>th</sup> Annual SOFC Program Review Meeting  
June 12, 2017**

# Technical Contributors

## UConn

Prabhakar Singh	Professor
Rampi Ramprasad	Professor
Steven Suib	Professor
Boxun Hu	Assistant Research Professor
Ashish Aphale	Post-doctoral fellow
Aman Uddin	Post-doctoral fellow
Sridevi Krishnan	Post-doctoral fellow
Su Jeong Heo	Graduate Student
Junkai He	Graduate Student
Yanliu Dang	Graduate Student
JunHo Song	Graduate Student
Justin Webster	Undergraduate Student
Seraphim Belko	Undergraduate Student
Manoj Mahapatra	Assistant Professor

## UAlabama

Program Managers: Drs. Patcharin N. Burke and Jason Lewis, NETL

# Outline

- **Accomplishments**
- **Background**
- **Experimental**
  - **Getter optimization, process scale up and stability evaluation**
  - **Evaluation of getter performance**
  - **Fabrication and long term testing of Cr Getter**
  - **Electrochemical testing – BOP & In-Cell simulation**
  - **Characterization-SEM-EDX, XRD, and FIB-TEM**
  - **High surface area (HSA) getter materials**
  - **Sensor Development for in-situ Cr monitoring**
- **Results and Discussion**
- **Future Work**
- **Acknowledgements**

# Long term SOFC Degradation – Role of Cathode

A Universal Degradation Phenomena for HT Electrochemical Systems

SOFC  
SOEC  
OTM

## Cathode Degradation

Ohmic losses

Non-ohmic losses

Mechanical changes

Gas phase  
constituents and  
contaminants

Gas – Solid Reactions

Solid – Solid Reactions

Solid state reaction  
and Inter-diffusion

Dopant exolution, Compound Formation, Surface Morphology Changes, Interface Diffusion

Gas	Concentration
Oxygen	20.9 v%
Nitrogen	78 v%
Water	<1 to 3 v%
Carbon dioxide	350 ppm
Sulfur dioxide	<1 ppm
Noble gases	<1 v%
Particulate matter (PM)	<50 $\mu\text{g}/\text{m}^3$

Air in fuel cell stack and system may also contain component derived impurities such as Cr (from metals and alloys) Si, B, and alkali (from glass and insulation).

# Chromium Evaporation at Low & Intermediate Temperatures

## Oxidation and electrochemical poisoning

Gaseous Cr species formation and transport remains a significant issue at lower temperatures similar to high temperature operation conditions. Presence of H<sub>2</sub>O in air will lead to high partial pressures of Cr species.

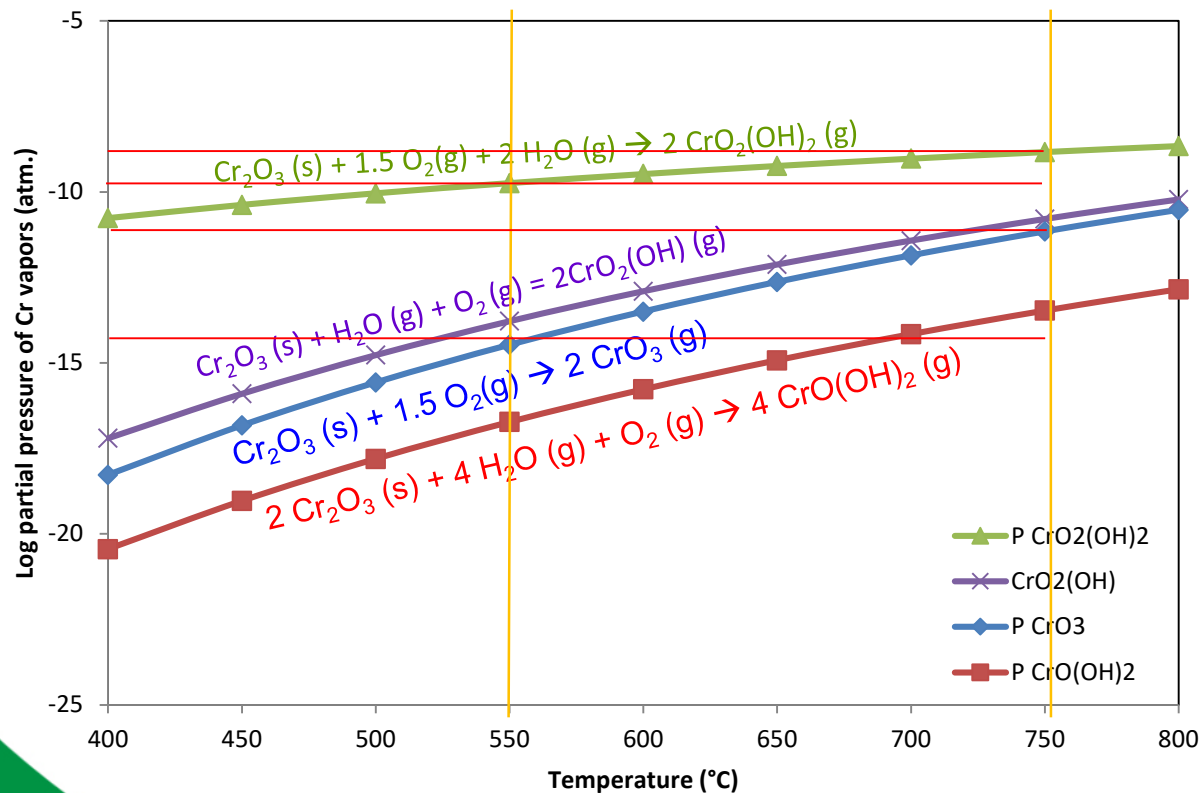

Air + 3%H<sub>2</sub>O atmosphere  
 $P_{\text{O}_2} = 0.21 \text{ atm.}$   
 $P_{\text{H}_2\text{O}} = 0.03 \text{ atm.}$

Paralinear oxidation  
 Electrode poisoning

- Alloy oxidation rate increases.
- Lowering of temperature does not significantly lower the Cr vapor pressure in humidified air as indicated by smaller slope.
- Significant reduction will, however, be obtained in dry air as indicated by larger slope.

# Background – Chromium Poisoning of Cathodes

## Morphology evolution in the presence of water and chromium vapor

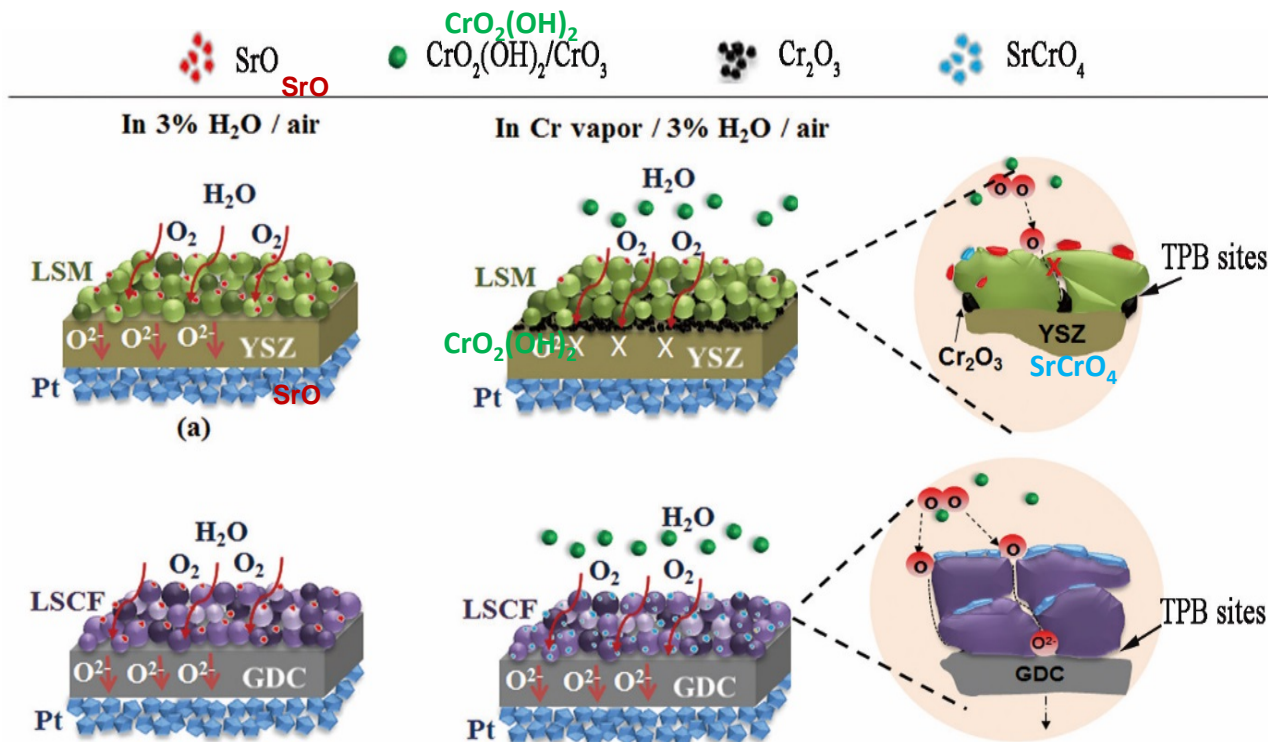

B. Hu, S. Krishnan, C. Liang, S. J. Heo, A. N. Aphale, R. Ramprasad, P. Singh, . *Int J Hydrogen Energy* , 2017

# Project Objectives

**Develop, Validate and Transfer Technology Related to Materials and Approaches for the Mitigation of SOFC Cathode Degradation in SOFC Power Systems**

**Long Term Bulk, Interfacial and Surface Stability**

Dopants, Electric polarization,  
Gas phase contaminants ( $H_2O$ ,  $CO_2$ ,  
 $SO_2$ , Cr-vapor species, stoichiometry)

**Tools:** EIS, DC conductivity, XRD, SEM,  
X-ray absorption spectroscopy, XPS,  
SIMS, TEM, HTXRD

**Compound formation (Solid-solid/solid-gas reactions)**  
dopants exolution and oxides segregation at surface

- ✓ oxides and compounds at interface
- ✓ crystal symmetry
- ✓ microstructure
- ✓ Micro-cracking and/or delamination

**Bulk, Interfaces, Surface Stability**

**Electrode – Electrolyte / Electrode - IC**

**Couple/ Symmetric / Full cell/ configurations**

**Air side contaminants:**  
Water,  $CO_2$ ,  $SO_2$ , Oxide vapors  
Other contaminants

**In-situ, Ex-situ Bench top tests**

# Accomplishments

- **Cr capture successfully demonstrated from BOP/ In-cell sources**
- **Cr getter identified, synthesized, tested and characterized**
- **Synthesis process scaled up to 1kg/batch using lab equipment**
- **Design studies performed for 40,000 hrs. getter life**
- **Cr getter provided to PNNL, LG, Cummins, Ceres for testing**
- **Laboratory findings provided to SOFC industries**
- **Cathode degradation mechanisms identified**
- **Getter operation validated at low temperatures**
- **Alternate HSA getter has been identified and synthesized.**

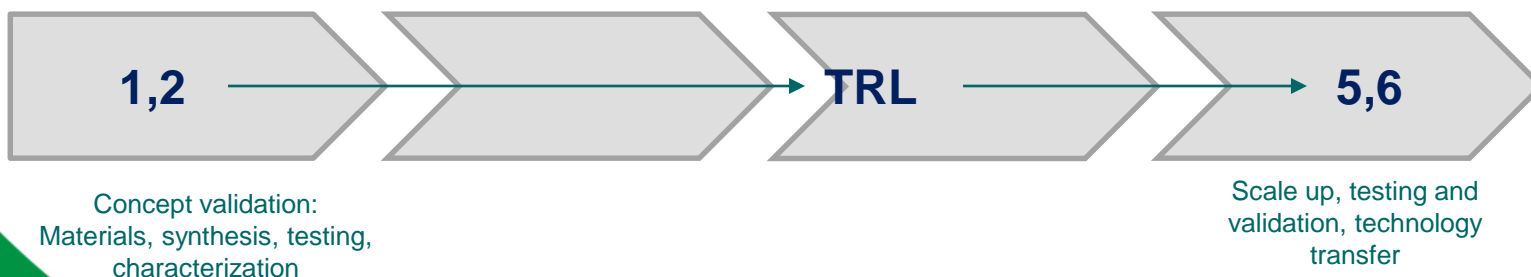



# Accomplishments-Technical

- Suitable metal oxides have been selected for co-getter materials using thermodynamic calculations.
- Processes have been identified for the synthesis of HSA materials
- As-synthesized HSA materials have been characterized using SEM, TEM and EDS techniques.
- In-situ electrochemical and ex-situ transpiration tests have been conducted to validate co-getter efficacy for Cr and S capture.
- Getter design is being further optimized by CFD computational analysis.
- New sensor design have been examined to test the sensitivity of Cr.

- Developed chromium getter shows excellent affinity for capturing gaseous Cr<sup>6+</sup>. Experiments are in progress on validating the capture of Sulfur and Sulfur-chromium species, respectively.
- Pre-formed and “in-situ” getter preparation demonstrated
- Electrochemical and transpiration tests show excellent blockage of Cr vapor from entering into cathode electrode.
- Getter materials, support structure and HSA getter deposition processes are being developed and optimized.

- Graduate / Undergraduate students being trained - 7
- Post-doctoral fellows - 3
- Outreach: Middle and High School, STEM, International academic institutions
- Publications in peer reviewed journals

# Background: Getter

A list of Cr getter properties against the state of the art Cr poisoning mitigation and getter materials

Cr getter critical property	Performance of new Cr getter against baseline state of the art Cr getter	Test conditions (Temp, time, atm)
<b>Phase Stability</b>	Superior: New Cr getter shows no phase changes and interaction with humidity and CO <sub>2</sub> present in air.	RT-980C, Ambient air
<b>Reaction products</b>	As processed getters consist of several oxide phases containing Sr and Ni (Sr <sub>9</sub> Ni <sub>7</sub> O <sub>21</sub> , Sr <sub>4</sub> Ni <sub>3</sub> O <sub>9</sub> and Sr <sub>2</sub> Ni <sub>4</sub> O <sub>5</sub> ).	Powder synthesis process and transpiration, electrochemical testing at 850C for up to 500 hrs in Air -3%H <sub>2</sub> O
<b>Microstructures</b>	Stable powder, coating and substrate microstructures obtained New Cr getter retains its microstructure after high temperature exposures (850C) in humidified air. Literature review does not provide background information on the SOTA.	During processing up to 980C in air During bench top testing at 850C for up to 500 hrs in humid air
<b>Thermochemistry</b>	Similar or Superior: Based on thermochemical models developed	
<b>Physical Properties</b>	Similar or Superior: Based on resistance to ambient air (NAAQS)	
<b>Product morphology</b>	Porous powder coating on ceramic substrates	During processing up to 980C in air During bench top testing at 850C for up to 500 hrs in humid air
<b>Cr Conc. profile</b>	Superior: Capture Cr in the first 1500 - 3000 micron. Reproducible results	During bench top testing at 850C for up to 500 hrs in humid air
<b>Substrate</b>	Configuration include honeycomb, foam and fibrous structure, Substrate materials include Cordierite, Mullite, zirconia and alumina.	
<b>Ease of fabrication</b>	Conventional powder preparation and coating techniques	pre-formed /In-situ getter formation

# Novelty and Innovation

- **Design flexibility for integration in wide range of SOFC systems configuration**
- **Flexibility of operation from 600-900°C**
- **Use of conventional non-strategic and non-noble low cost metal oxides for getter synthesis**
- **Ease of getter synthesis and fabrication**
- **High Cr capture capacity through tailored high surface area powder and coatings**
- **Replaceable unit with getter health monitoring and sensing**

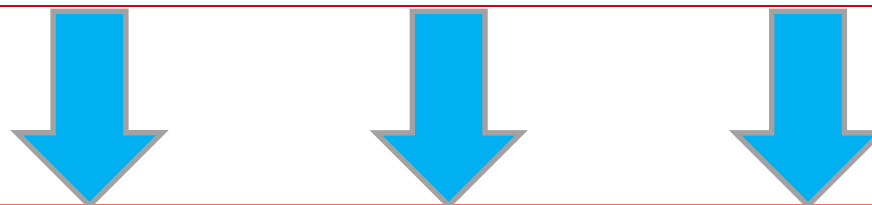

The innovation will also find application in related high temperature electrochemical systems such as OTM and SOEC for the prevention of Cr assisted performance degradation. The proposed approach for Cr capture can also be applied to oxycombustion and other advanced combustion techniques for the reduction of Cr vapor in the exhaust gas stream.

# Getter Chemistry Optimization and Scale up

Validation and testing



# Large-Scale Getter Material Synthesis

**Objective:** Produce a large batch of SNO for industrial application

**Approach:** Scale up smaller 20g batches of SNO to produce 1kg batch.

**Rationale:** Using results from initial 20g and 100g batches, 250g batch is prepared to produce SNO with desired composition. XRD results from assay and temperature comparison of 20g batches were used to optimize 250g batch.

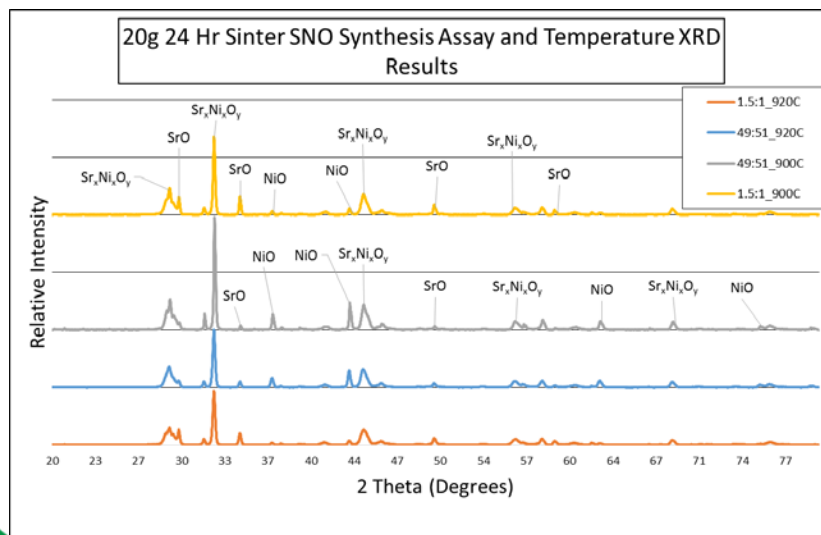

**Previous Work :** 20g batches were used to optimize powder composition of large batch with respect to initial assay and sinter temperature. Optimal composition and temperature were found to be 49:51 Sr to Ni ratio sintered at 900°C as shown.

# Alternate Synthesis Processes

Synthetic Method	Advantages	Disadvantages
Microwave	Fast, high surface area	Lack of affinity
Sol-gel	Simplicity, high surface area	complex
Impregnation	Doped ions and form secondary coating layer	Need two steps
Hydrothermal	Uniform crystal size	Low surface area, high energy needed
UCT	Form porous thin layer with HSA	complex

# Process Flowchart

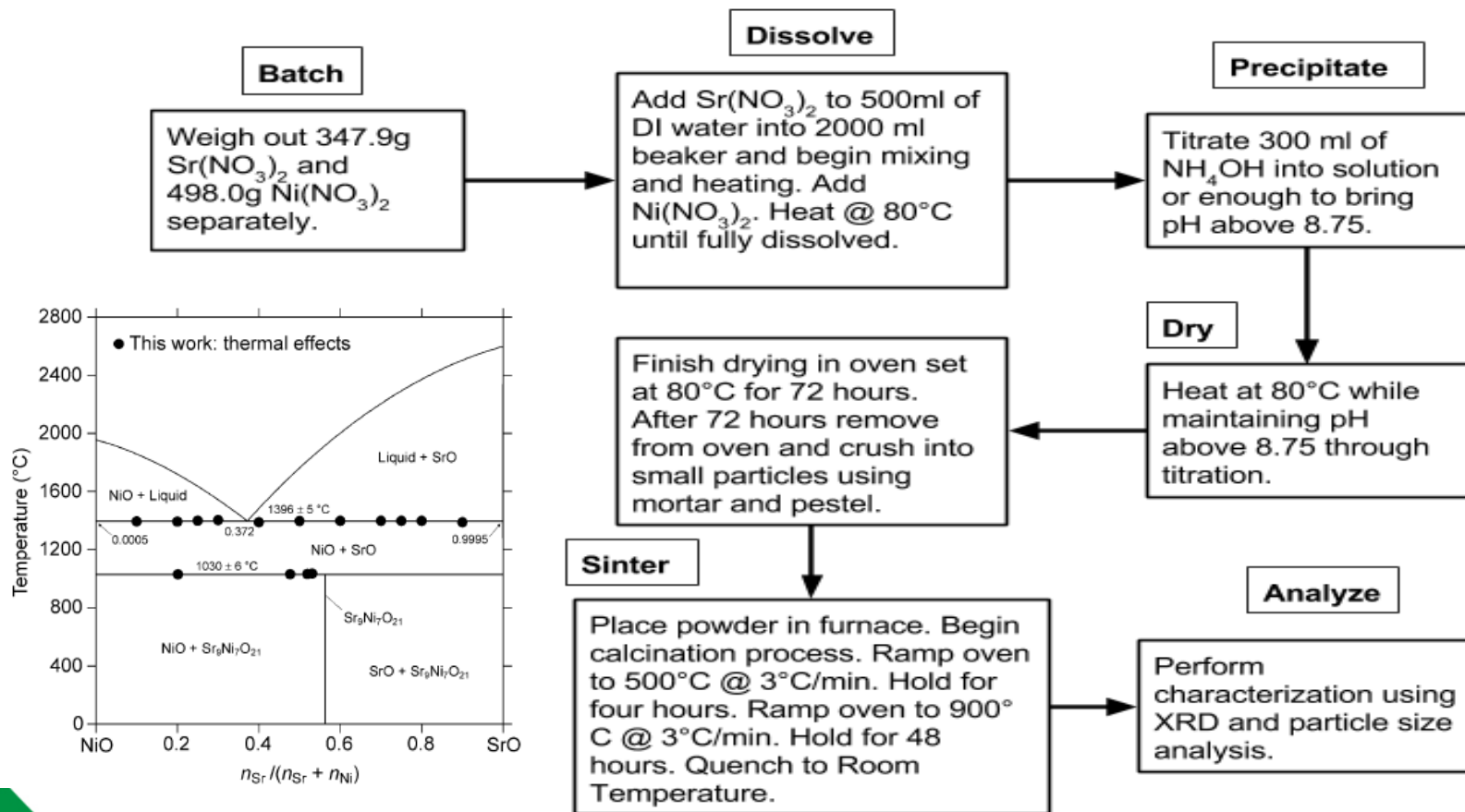



# Synthesis Methods for High Surface Area Getter

## MO<sub>x</sub> nanofibers

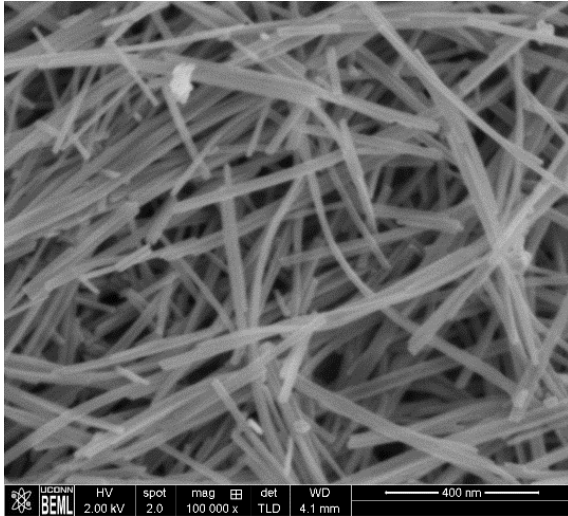

Microwave Method

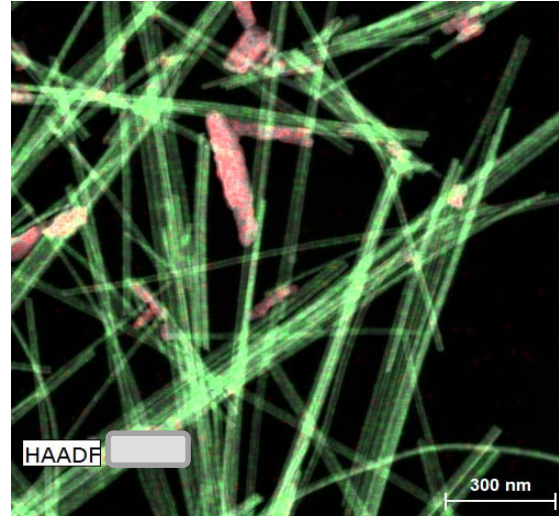

Impregnation Method

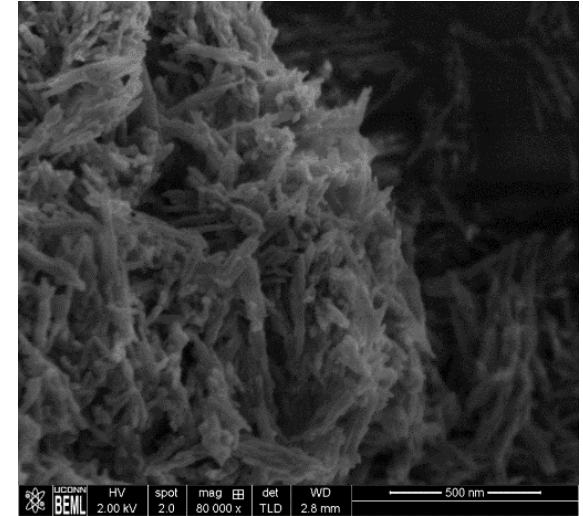

Hydrothermal method

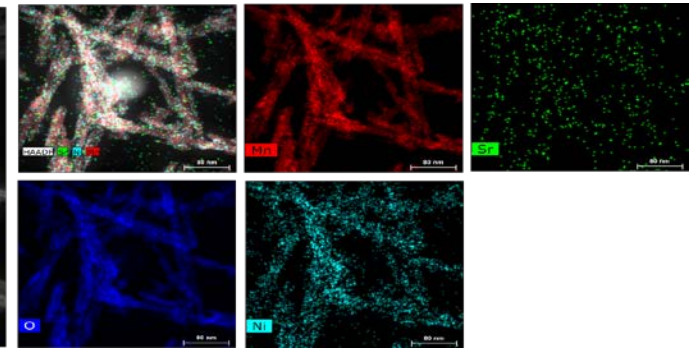
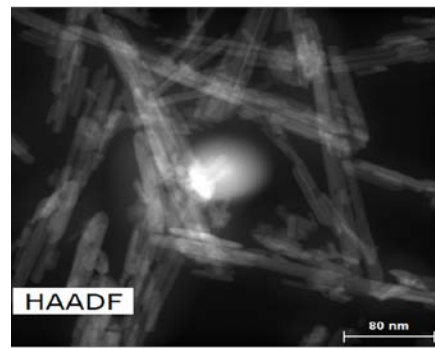
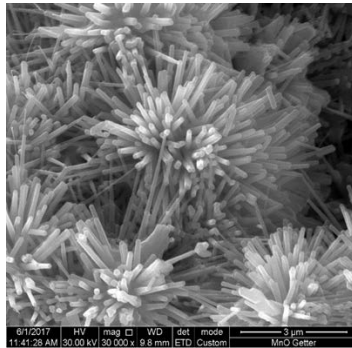

# Honeycomb/ Foam Substrate Getters

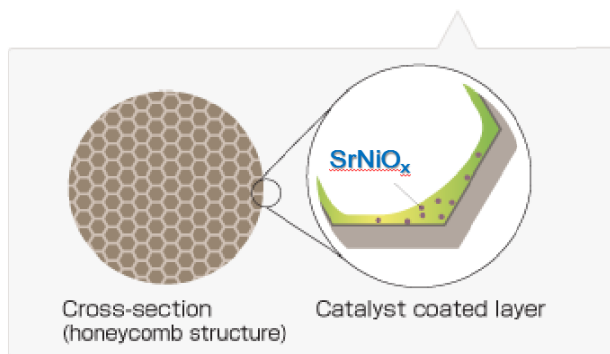
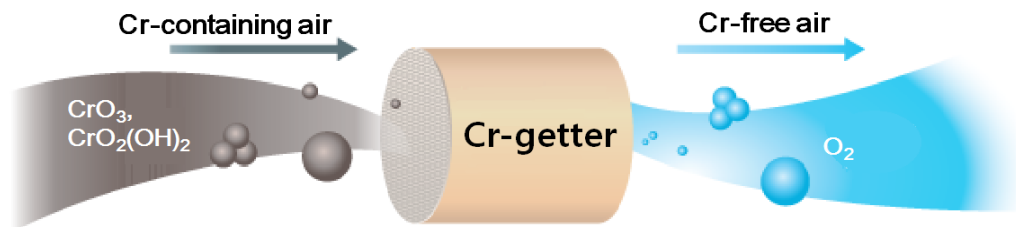

**Dip-coating from suspension**

Before

After

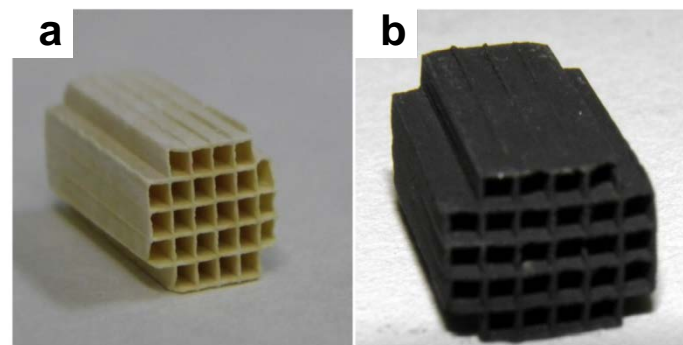

Schemes of Cr getter with honeycomb structure surface-coated with  $\text{SrNiO}_x$

Filter coated with  $\text{SrNiO}_x$ : (a) before and (b) after

**High surface area and porous  $\text{SrNiO}_x$  coating (10-30  $\mu\text{m}$ )**

# Coating Optimization: Slurry coating of honeycomb

## 1<sup>st</sup> coating

After RT drying

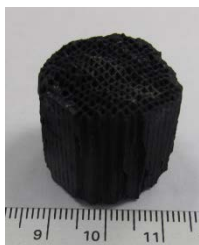

After 900C heat treatment for 5 hour

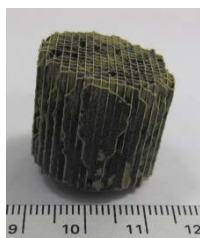

## 2<sup>nd</sup> coating

After 850C heat treatment for 5 hour

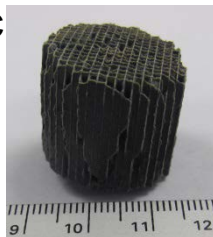

## 3<sup>rd</sup> coating

After 900C heat treatment for 5 hour

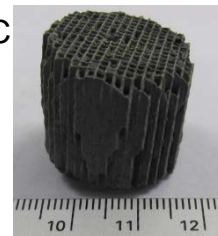

Coating	#5
SNO	10g
Durban	1.2ml
PVP	3g
Cement	1g
Solvent	50%/50%
50ml	Water/Ethanol

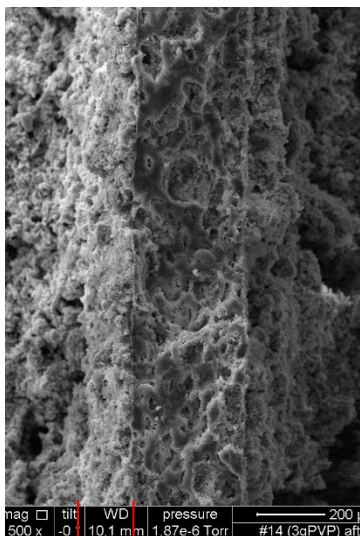

40µm

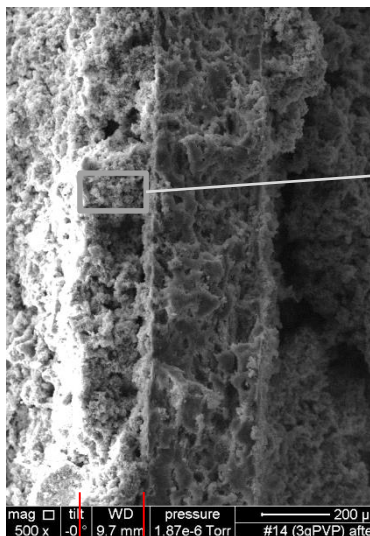

50-60µm

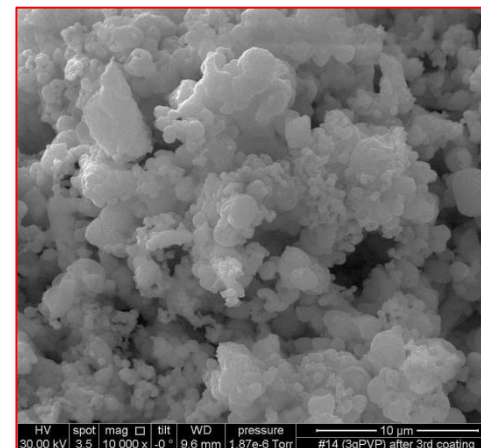

### EDS Quantitative Results

Element	Wt%	At%
AlK	13.84	30.57
NiK	32.35	32.84
SrK	53.81	36.60

- After 3rd coating, coating thickness: 40-60 µm.
- Coating is porous.



# Coating Optimization: Slurry coating of honeycomb

## Cross section

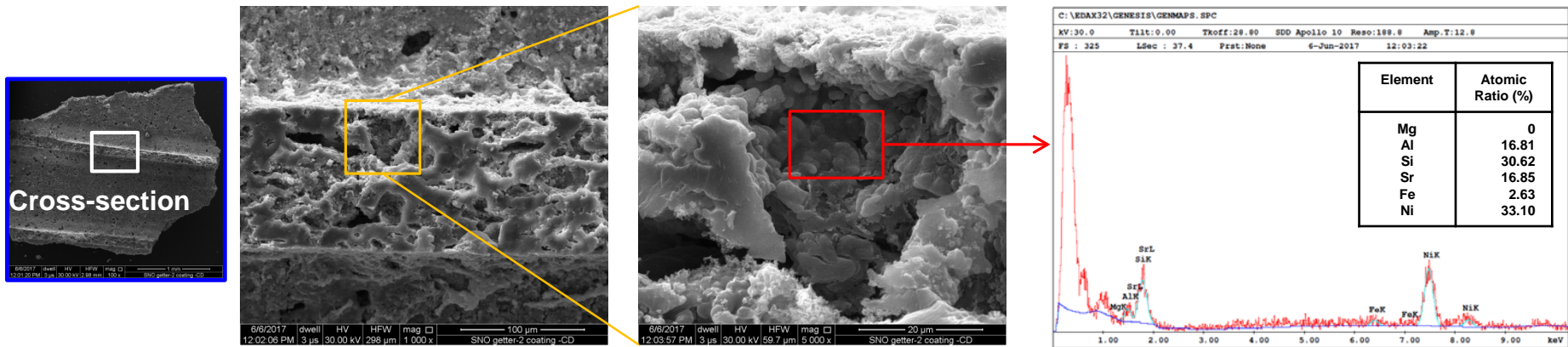

SEM images of the cross-section of the Cr getter and elemental analysis by EDS.

Pores in the substrate (cordierite) contain Sr and Ni

It is suggested that the SrNiOH penetrated into the holes cause strong adhesion between the coated layer and the substrate.

The SrNiO layer is ~10 – 15  $\mu\text{m}$  in thickness.

# Stability of Getter Materials

Before sintering



850°C (20h)



After sintering

1000°C (20h)



post sintering  
24h in air at RT

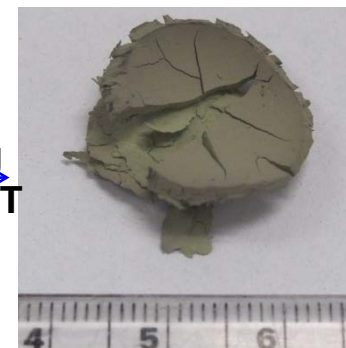

- Evaluate the stability of SrNiOx
- Validate in-cell getter to capture Cr from IC source

- Sintering at 850°C for 20h: No change in color and shape of the pellet
- Sintering at 1000°C for 20h: Pellets became brown and the shape was intact immediately after removal from furnace at room temperature, but after 24h the pellets were pulverized completely.

- No/ negligible changes in morphology was observed for SNO sintered at 850°C for 20h
- Particles agglomeration was observed for SNO sintered at 1000°C for 20h

# Thermal stability

Pellets of SrNiOx sintered at 850°C and 1000°C for 20h

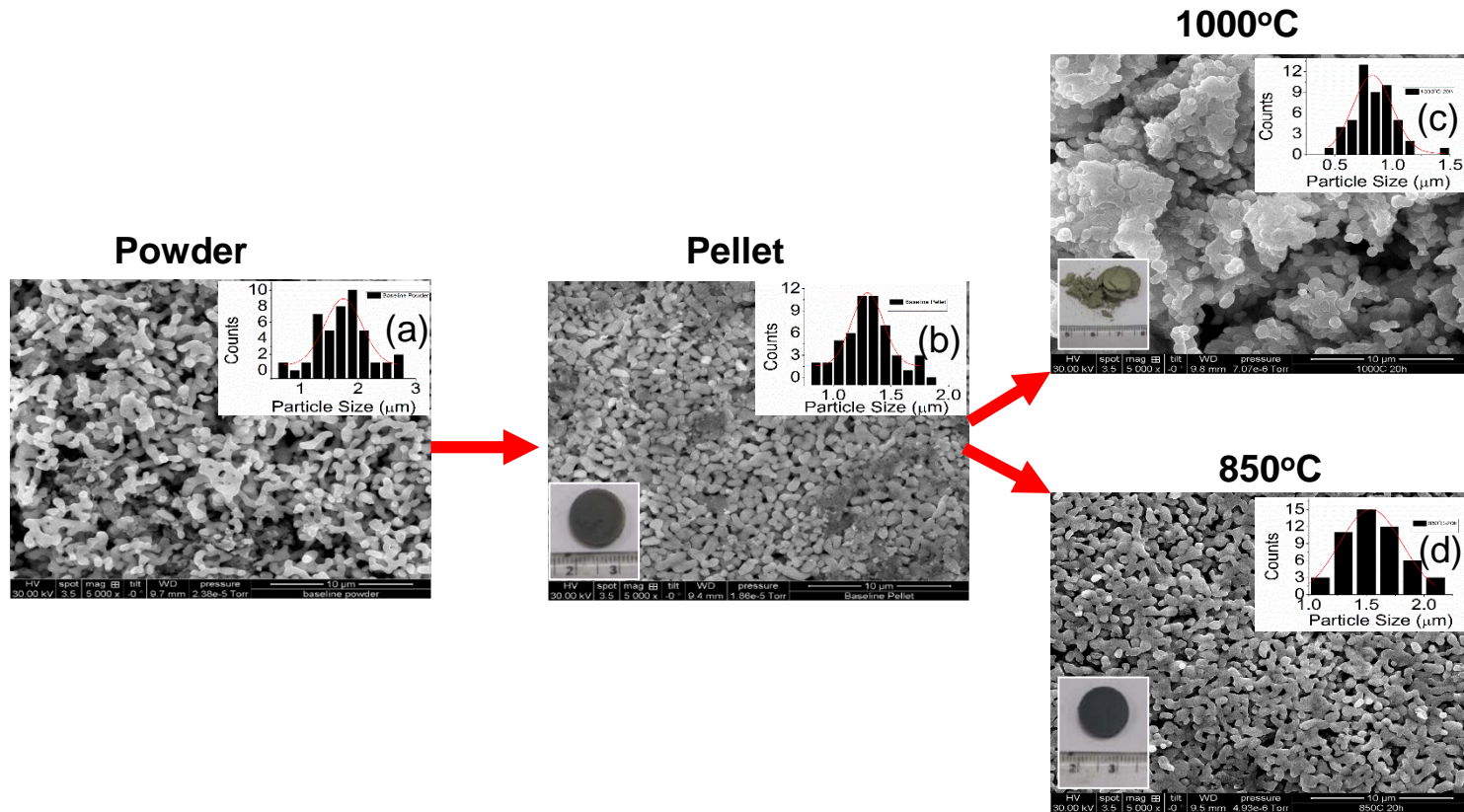

- No change in color and shape of the pellet after sintering at 850°C for 20h
- Sintering at 1000°C for 20h leads to pulverization of SNO powders. Initially the pellets turn brown in color immediately after taking out of the furnace with changing to green and completely pulverized after 24h left in lab atmosphere.

# Post sintering XRD characterization

XRD was conducted after sintering the pellets at 850°C and 1000°C and left in air for at least 24 hours

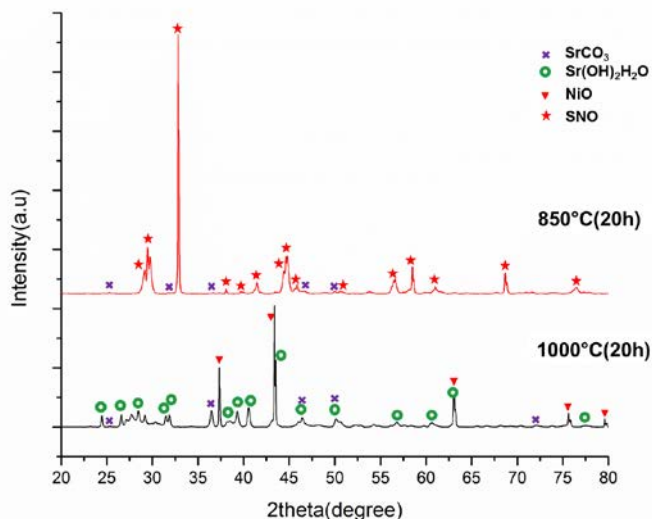

850 °C (20h)



1000 °C (20h)



## Lattice volume

Material	Lattice	Volume (Å <sup>3</sup> )	Pattern
SrO	FCC	137.51	01-075-6979
Sr(OH) <sub>2</sub>	Orthorhombic	237.27	00-027-0847
SrCO <sub>3</sub>	Orthorhombic	259.07	00-005-0418

## Molar volume

Material	Molar Mass (g/mol)	Density (g/cm <sup>3</sup> )	Molar Volume (cm <sup>3</sup> /mol)
SrO	103.62	4.70	22.05
Sr(OH) <sub>2</sub>	121.63	3.63	33.51
SrCO <sub>3</sub>	147.63	3.74	39.47

- The XRD pattern of 850 °C sintered SNO indicates presence of only Sr<sub>x</sub>Ni<sub>y</sub>O<sub>z</sub> phase with presence of minor SrCO<sub>3</sub> phase
- In contrast, XRD patterns of pulverized powder (1000°C) shows the presence of Sr(OH)<sub>2</sub>·H<sub>2</sub>O phase along with the strong peaks of SrCO<sub>3</sub>.
- Strong peaks of NiO phase appear with absence of SrO phase in XRD patterns of the pulverized samples.



# Getter Materials Stability

Phase Stability has been studied by high temperature *in-situ* XRD performed on SrNiOx powder for up to 40h

850°C

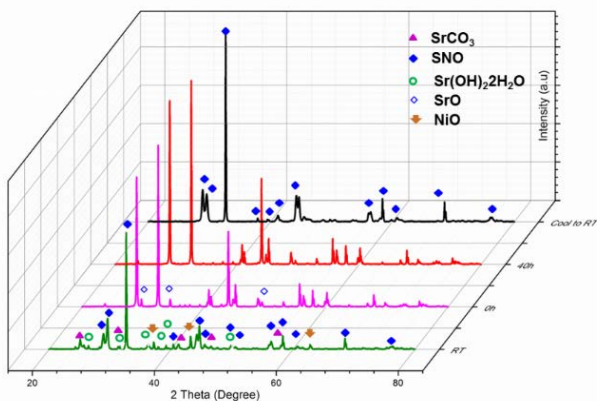

900°C

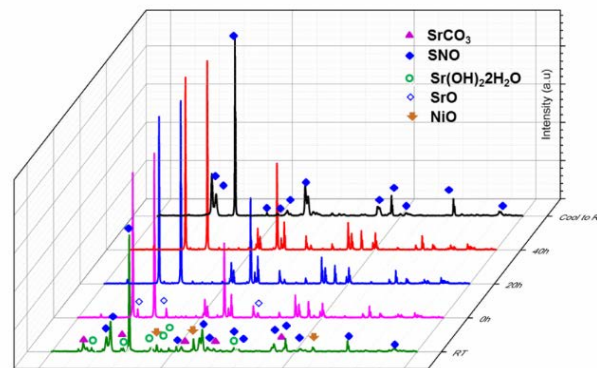

950°C

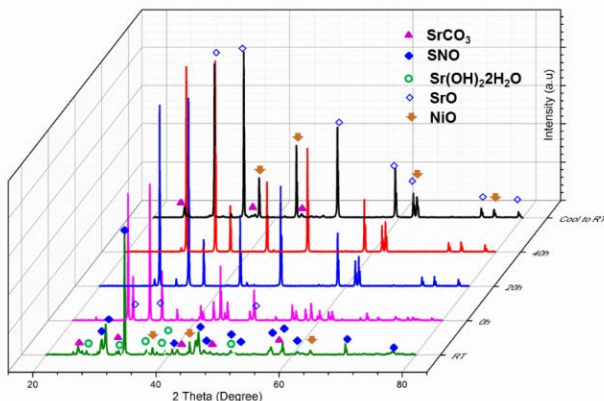

1000°C

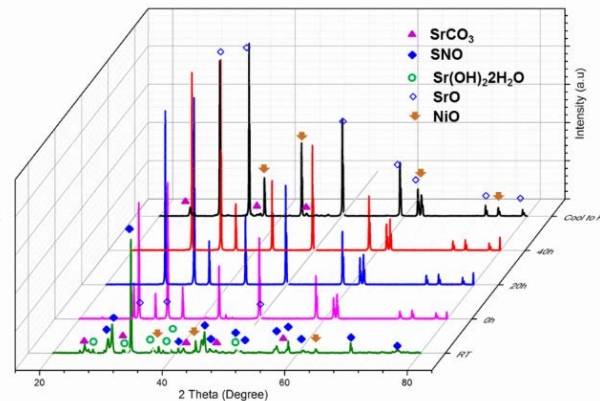

- SrNiOx demonstrated phase stability sintered at 850°C and 900°C.
- SrNiOx sintered at 950°C and 1000°C dissociates into SrO and NiO phases.



# TGA-DTA Analysis

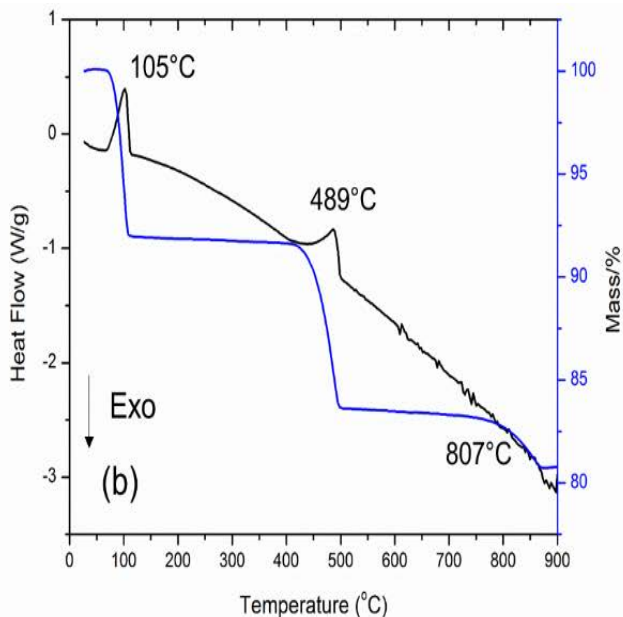
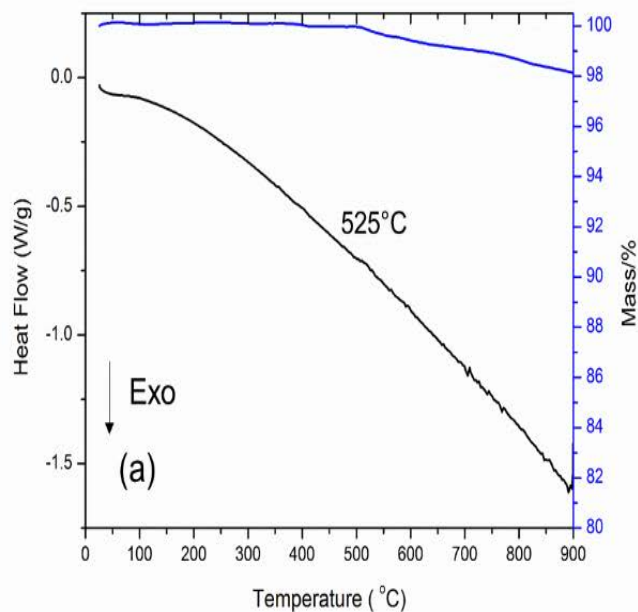

Endothermic peaks at 105 and 489°C indicating release of H<sub>2</sub>O from SNO powder samples sintered at (a) 850°C and (b) 1000°C (20Hrs)

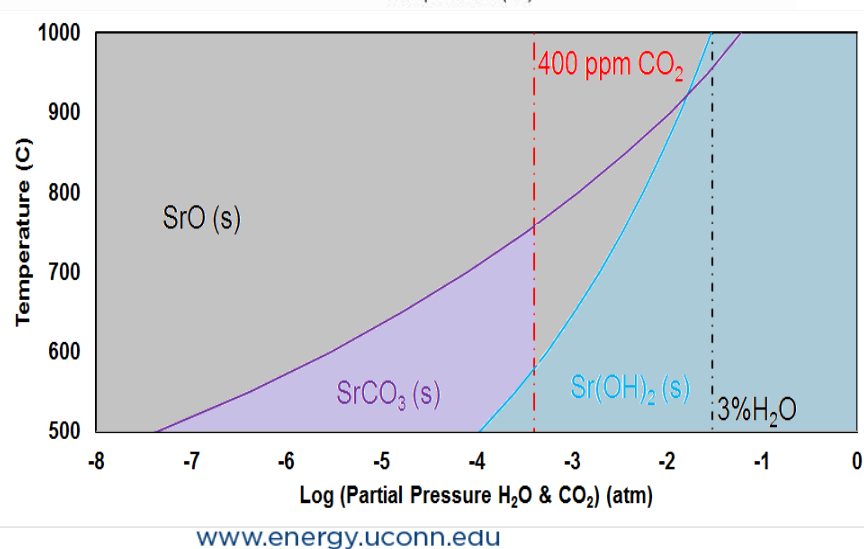

# In Stack Cr Capture

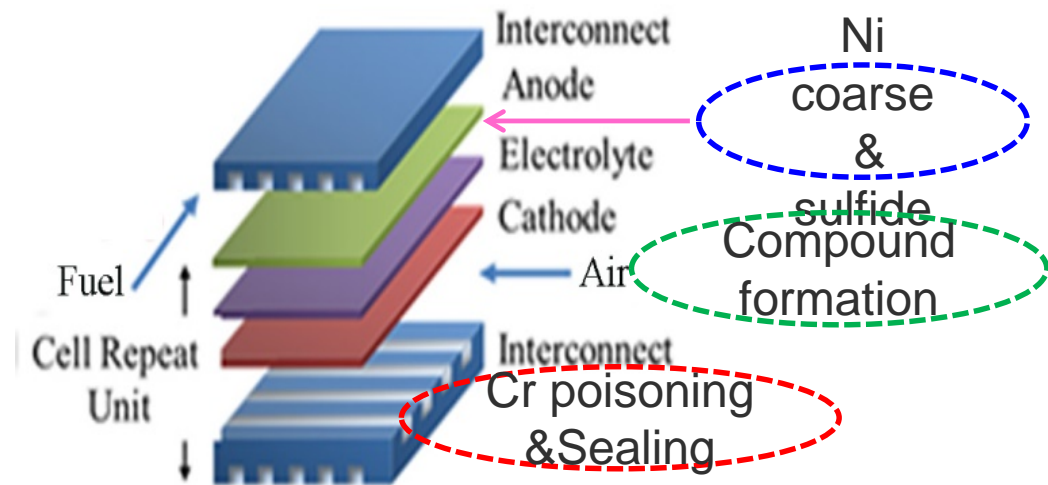

# Electrochemical Evaluation

## Half-cell configuration

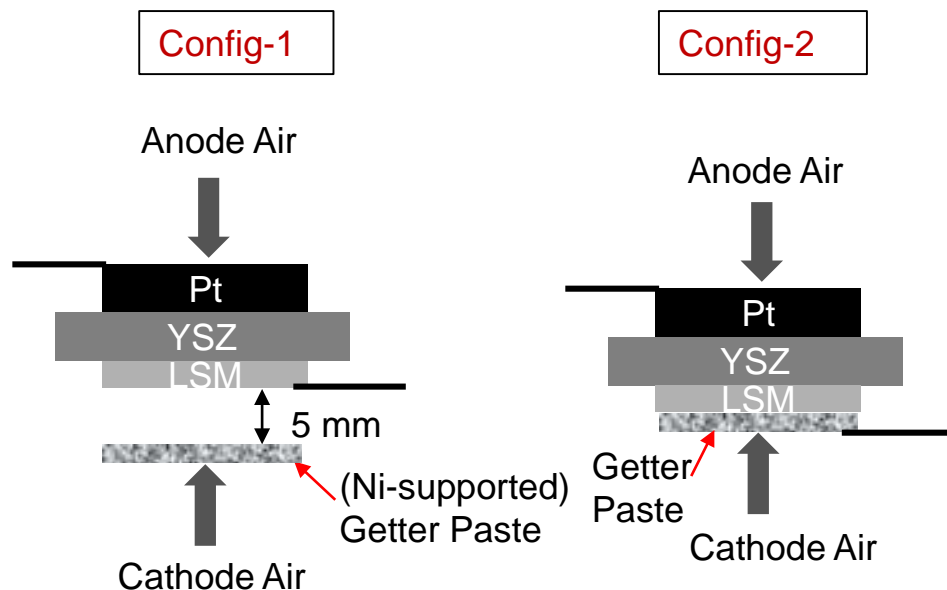

Conditions	
Temperature	850C
Flowrate	150 sccm
Cr Source	Cr <sub>2</sub> O <sub>3</sub>
Cr Getter	SNO/ LSCF-SNO composite
Bias	-500 mV

- Half-cell fabrication procedure was maintained for all the half-cell fabrication
- LSM was screen printed and sintered at 1200 °C for 1h
- SNO or LSCF/SNO getter was brush coated and sintered at 850 °C for 20h
- **Config-1:** Getter paste is 5 mm apart form LSM and **Config-2:** Getter paste is in direct contact with LSM

# Getter Materials Conductivity

## Electrical Conductivity

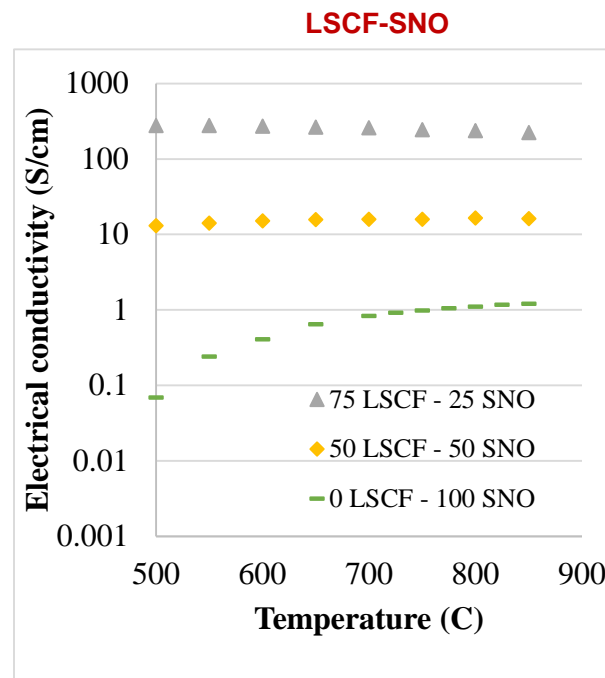
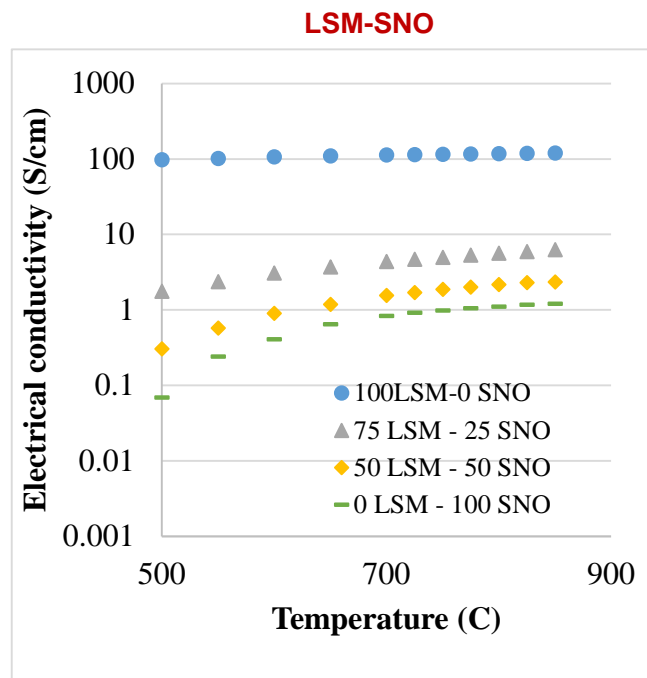

- Electrical conductivity of LSM is approximately 120 S/cm at 850°C
- Electrical conductivity of SNO is approximately 1.2 S/cm at 850°C
- Addition of SNO in LSM lowers the conductivity of LSM-SNO composites
- Electrical conductivity of LSCF is more than 800 S/cm at 850°C<sup>1</sup>
- LSCF-SNO composites display higher conductivity compared to LSM-SNO composites.

1. Q. Xu et al, Journal of Alloys and Compounds 454 (2008) 460–465

# Electrochemical Evaluation

## I-t data

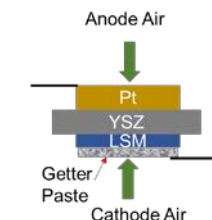
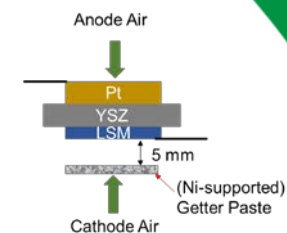
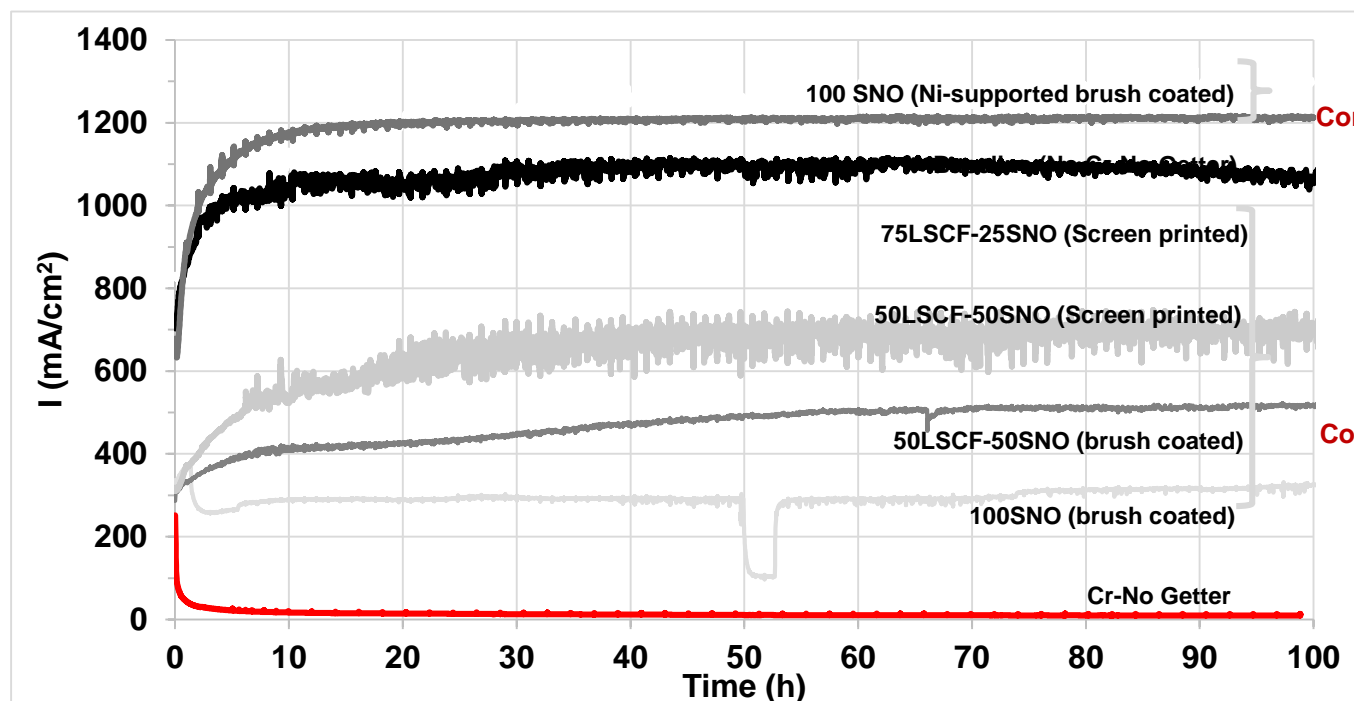

- I-t data shows stable performance for 100h in all the half-cell configurations
- Config-1 shows higher performance because of no direct contact of getter with the LSM cathode
- 75LSCF-50SNO getter shows higher current density (~1100 mA/cm<sup>2</sup>) as compared to 50LSCF-50SNO getter (~700 mA/cm<sup>2</sup>)

# Electrochemical Evaluation

## Posttest characterization (SEM)

### 75LSCF-50SNO (Screen printed) Cross-section

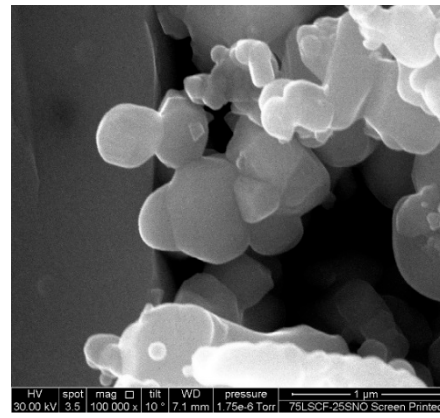
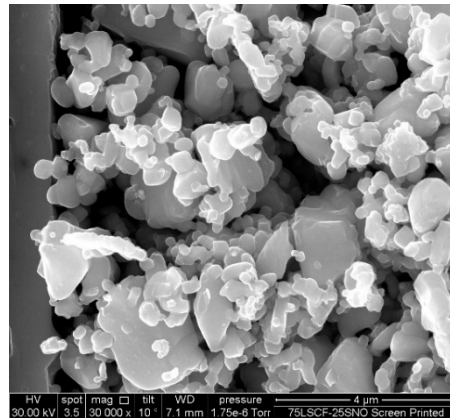
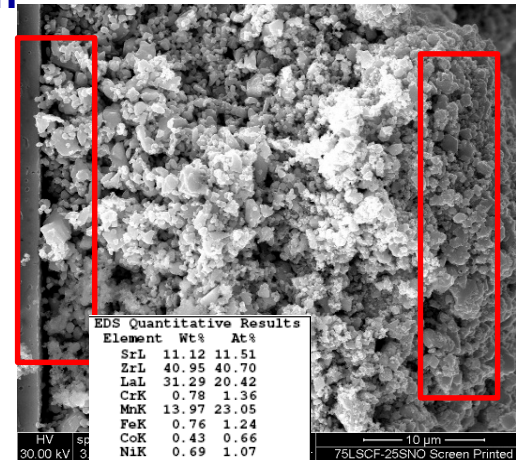
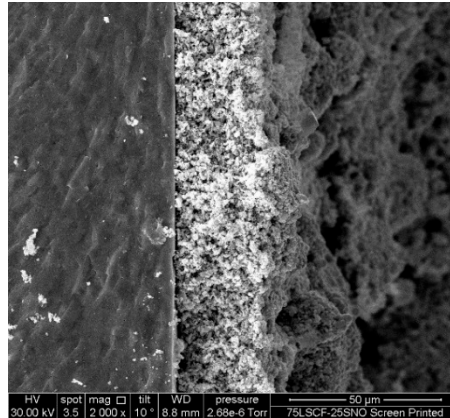

- Higher Cr concentration observed at the surface
- Cathode/ electrolyte interface remained free from Cr



# Electrochemical Evaluation

## Posttest characterization (SEM)

75LSCF-25SNO (Screen printed)

50LSCF-50SNO (Screen printed)

50LSCF-50SNO (Brush coated)

Surface

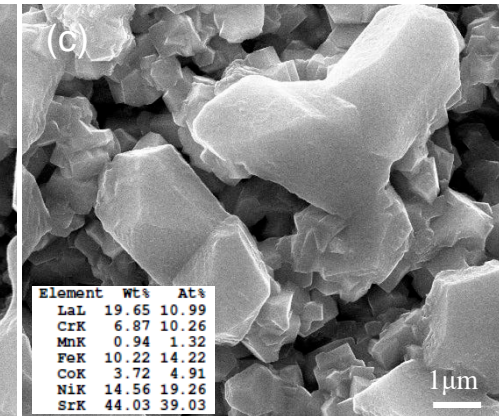
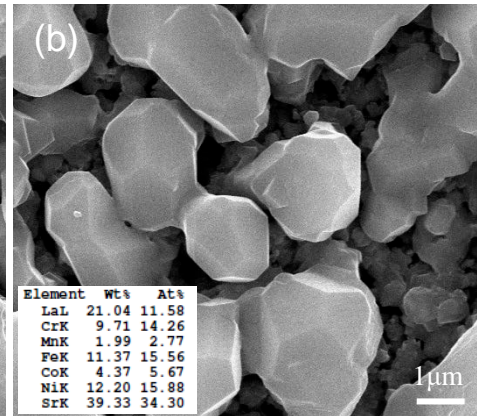
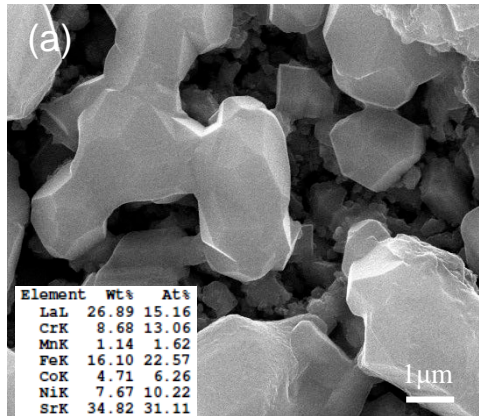

Cross-Section

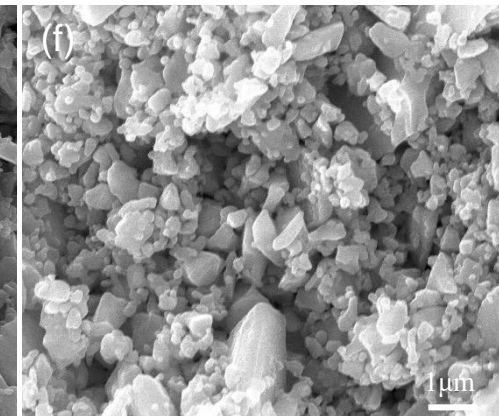
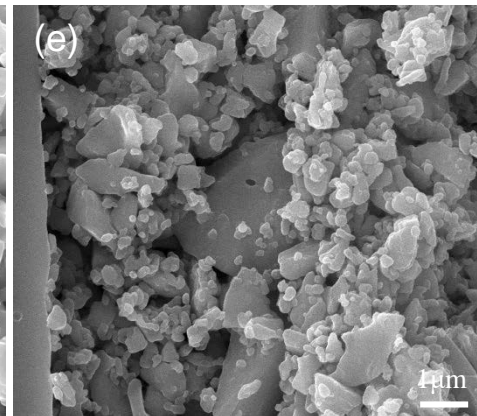
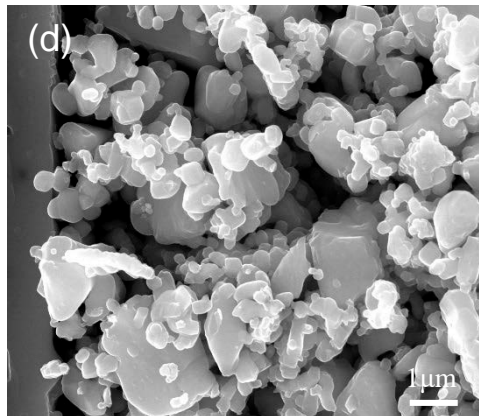

- All Cr are mostly captured at the surface of the cathode with faceted particle formation
- No Cr or product was found inside cathode or cathode-YSZ interface

# Getter reaction and Cr capture

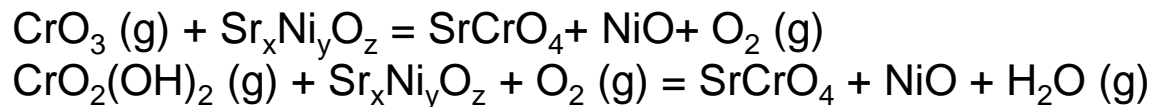
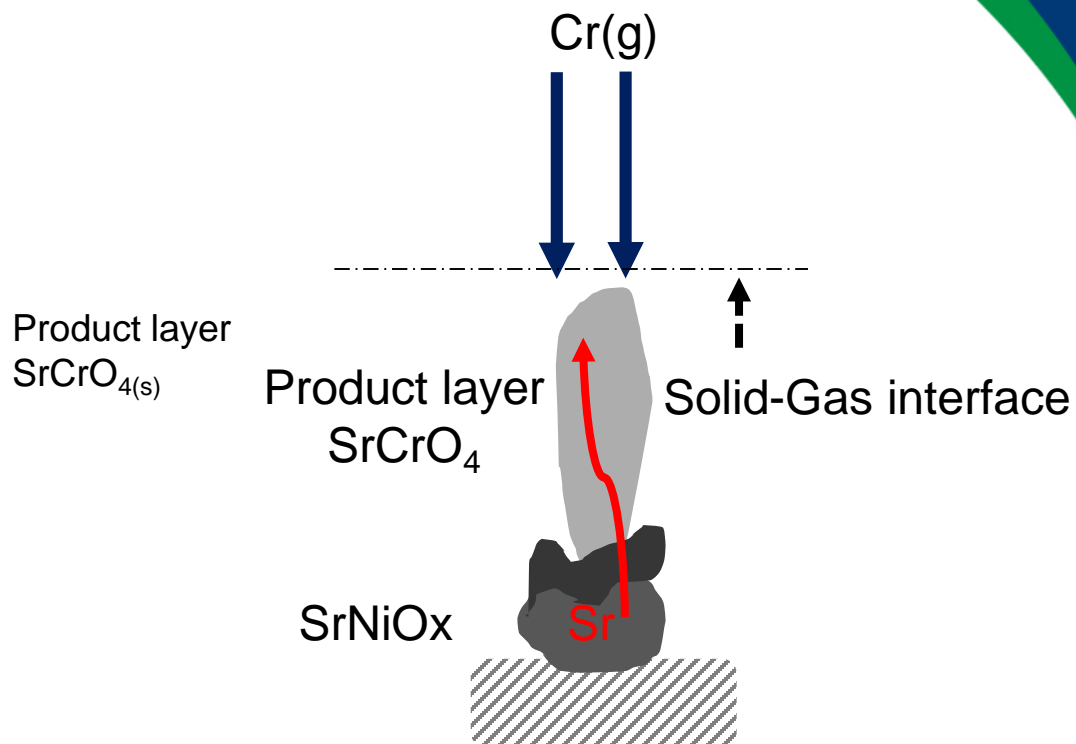
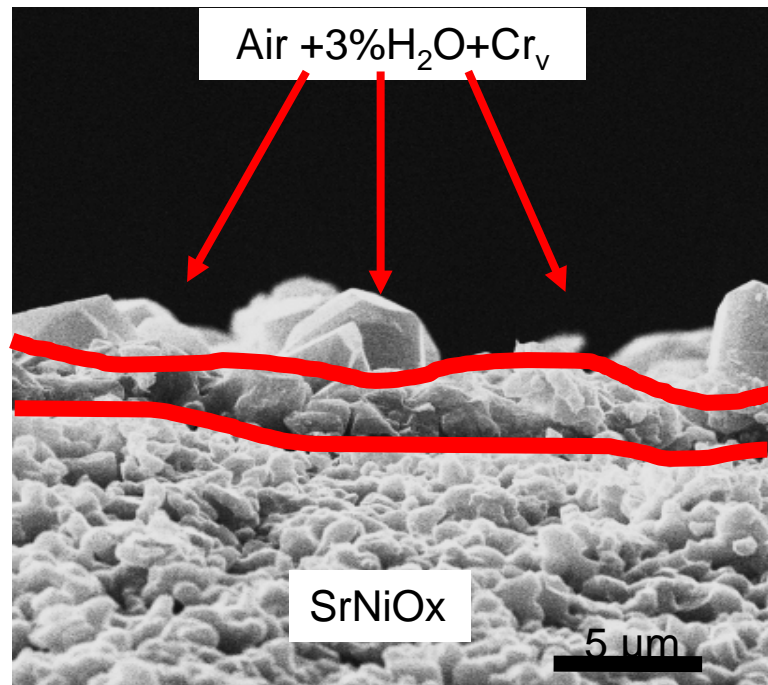



# In-Situ Electrochemical Characterization

## Test assembly : Half cell configuration

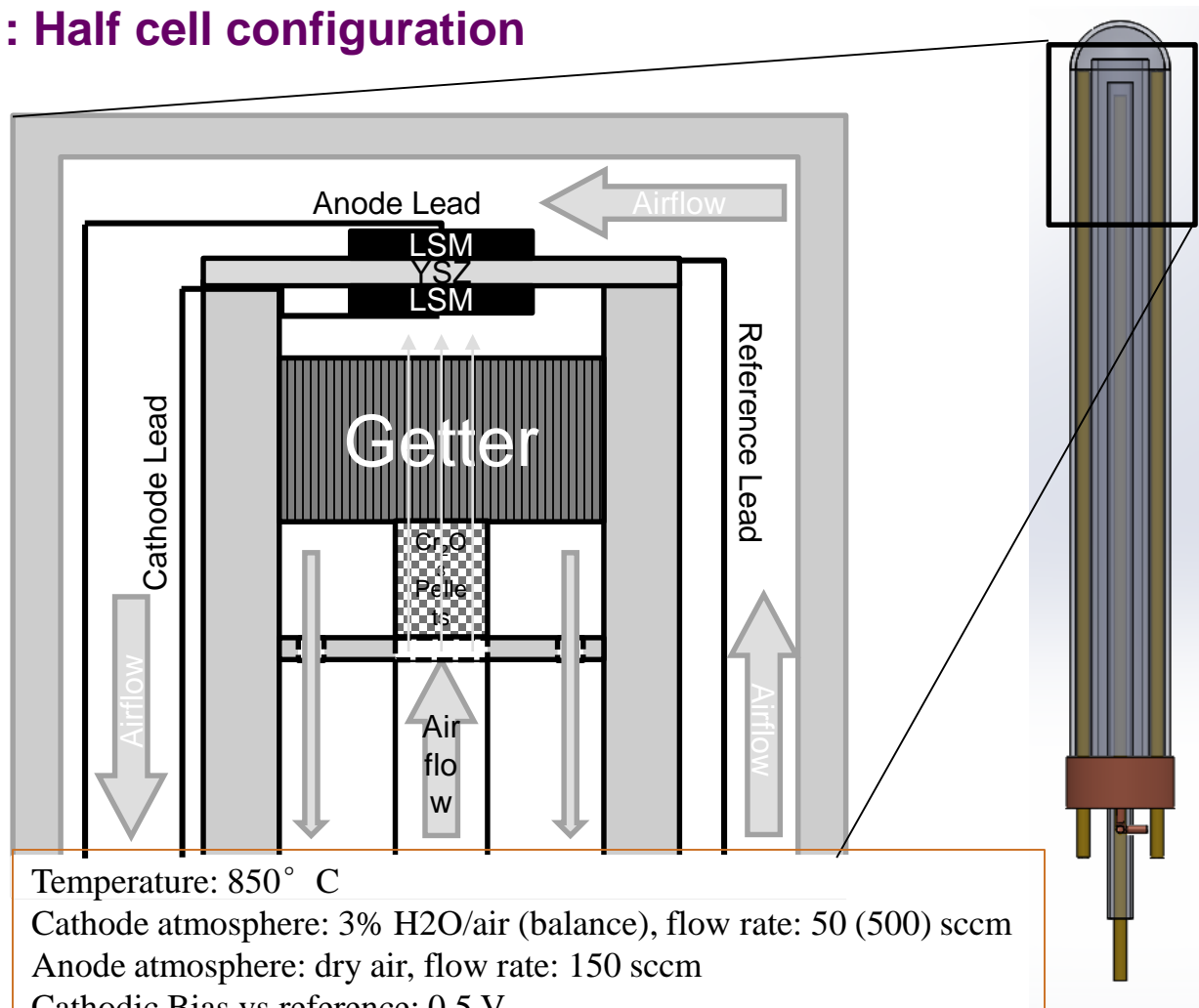

Temperature: 850° C

Cathode atmosphere: 3% H<sub>2</sub>O/air (balance), flow rate: 50 (500) sccm

Anode atmosphere: dry air, flow rate: 150 sccm

Cathodic Bias vs reference: 0.5 V

Getter: cordierite /alumina fiber supported SrNiOx

# Thermodynamic Analysis

# Thermodynamic Analysis

## Cr poisoning in SOFC cathodes

- Cr poisoning effects in SOFC cathodes
  - $(\text{La,Sr})\text{MnO}_3$
  - $(\text{La,Sr})(\text{Co})\text{O}_3$
- Ab-initio thermodynamic with a linear programming approach
- Reaction Energetics of the SOFC cathodes with  $\text{CrO}_3$

- \* The structure of the LSCO and LSMO at different Sr concentration have been studied.
- \* We have identified the minimum energy structures in each of the compositions and they agree well with experiments
- \* Reaction energetics of  $\text{CrO}_3$  with the compounds  $\text{La}_{0.5}\text{Sr}_{0.5}\text{CoO}_3$  and  $\text{La}_{0.75}\text{Sr}_{0.25}\text{MnO}_3$  were studied.
- \* We find that while LSCO results in reactive products for the experimental window, the LSMO remains unreactive

# Reaction energetics of $\text{La}_{0.5}\text{Sr}_{0.5}\text{CoO}_3$ Cubic

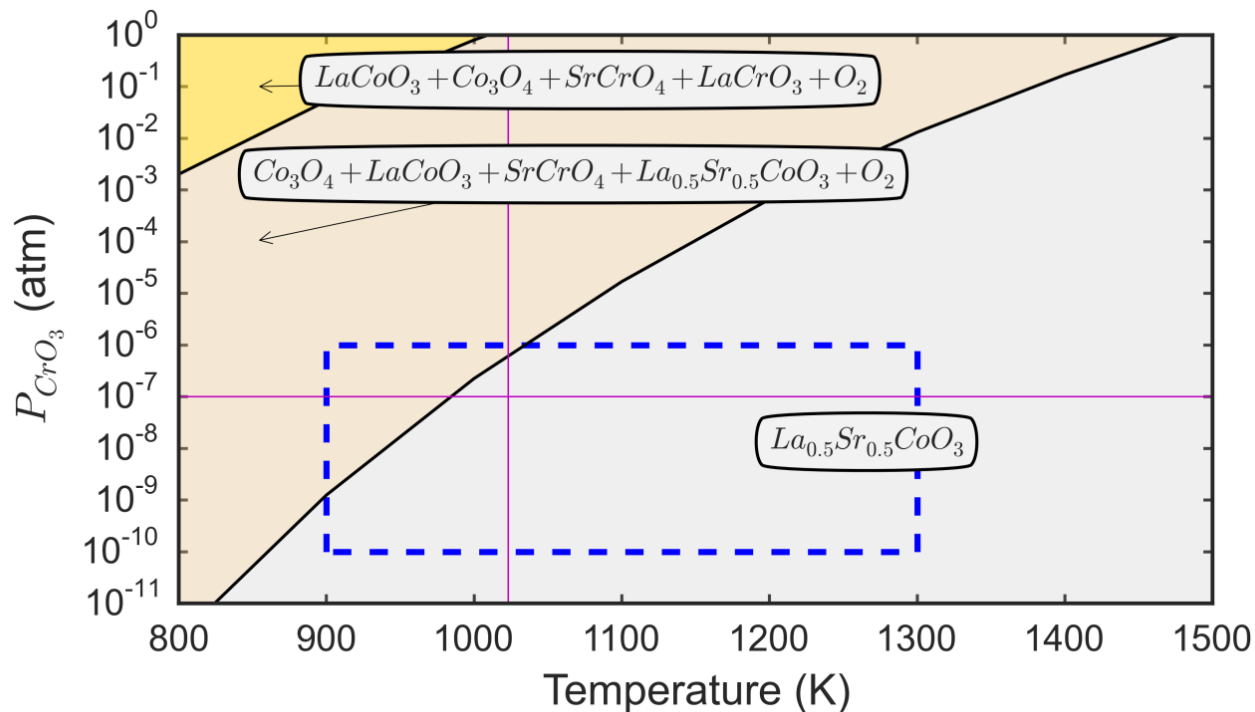

Based on the reaction energetics, the formation of these products:  $\text{LaCoO}_3$ ,  $\text{Co}_3\text{O}_4$ ,  $\text{SrCrO}_4$ , and  $\text{O}_2$  are energetically favored in the experimental window.

# Reaction energetics of $\text{La}_{0.75}\text{Sr}_{0.25}\text{MnO}_3$ Cubic

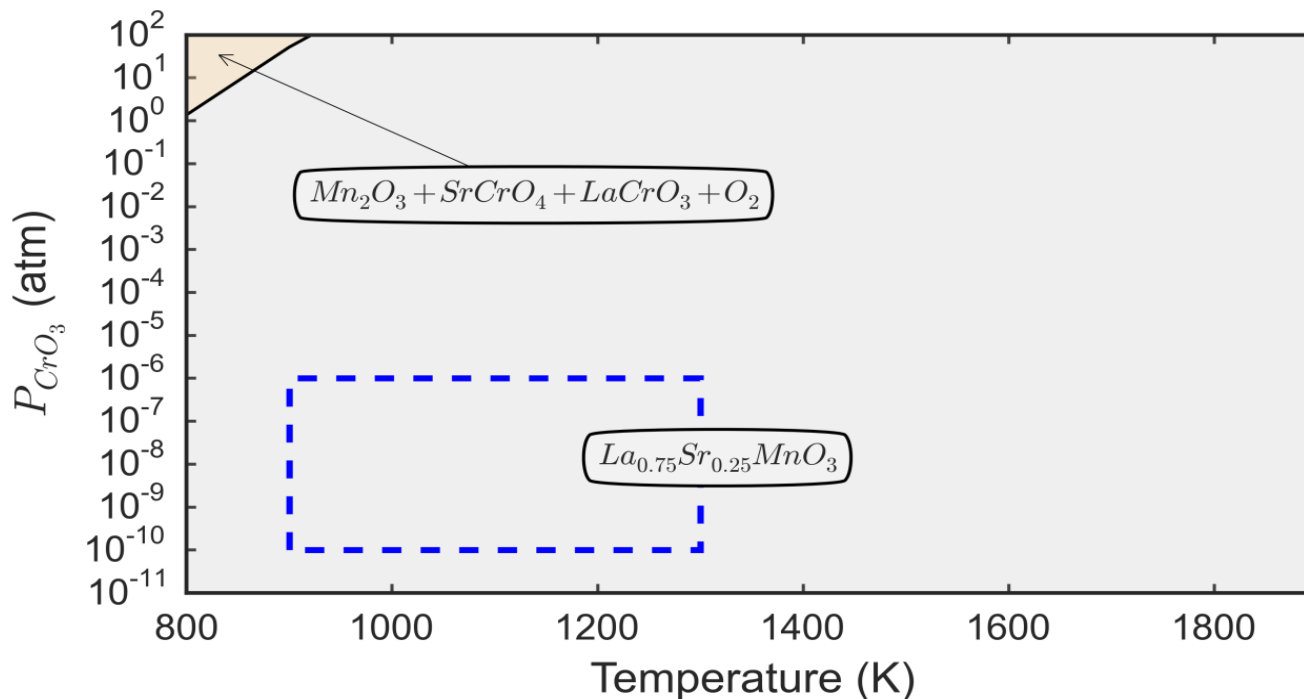

Based on the reaction energetics, the formation of Cr deposition products are not energetically favored in the experimental window.

# Background – Chromium Poisoning of Cathodes

## Morphology evolution in the presence of water and chromium vapor

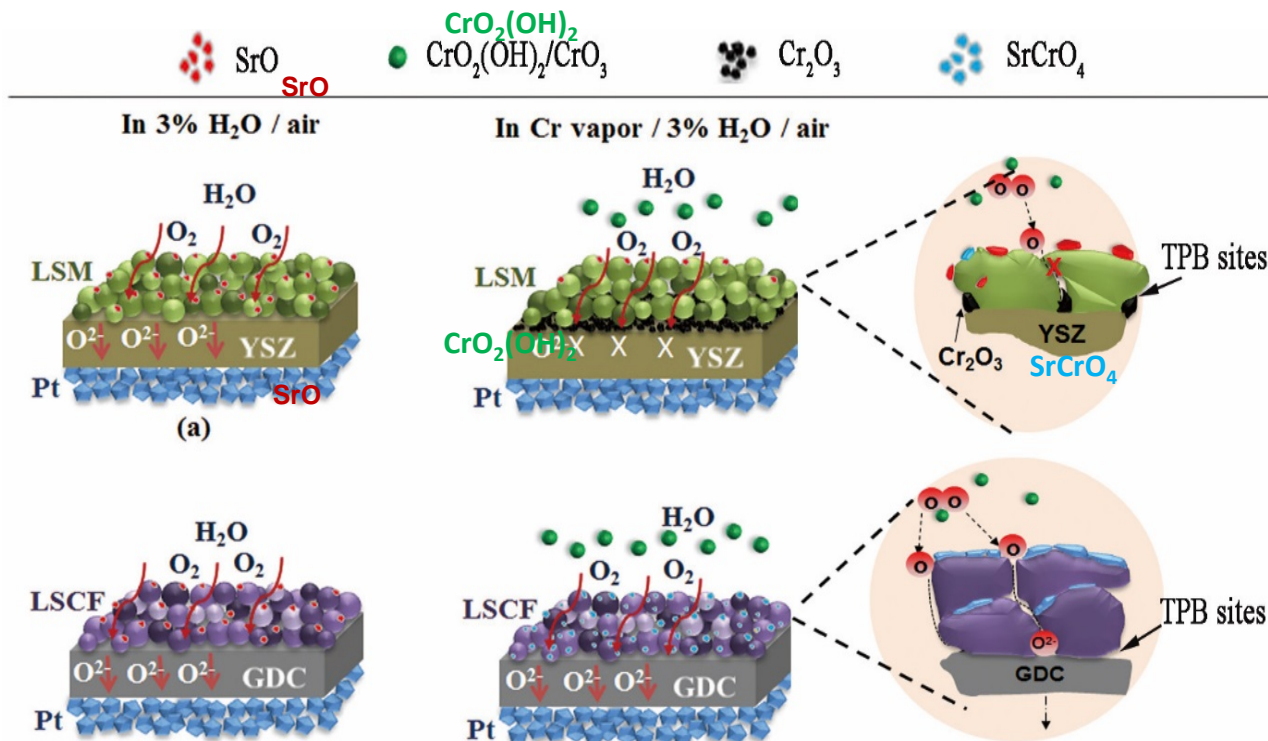

B. Hu, S. Krishnan, C. Liang, S. J. Heo, A. N. Aphale, R. Ramprasad, P. Singh, . *Int J Hydrogen Energy* , 2017

# Co-oxidation of Cr and SO<sub>2</sub> on metal oxides

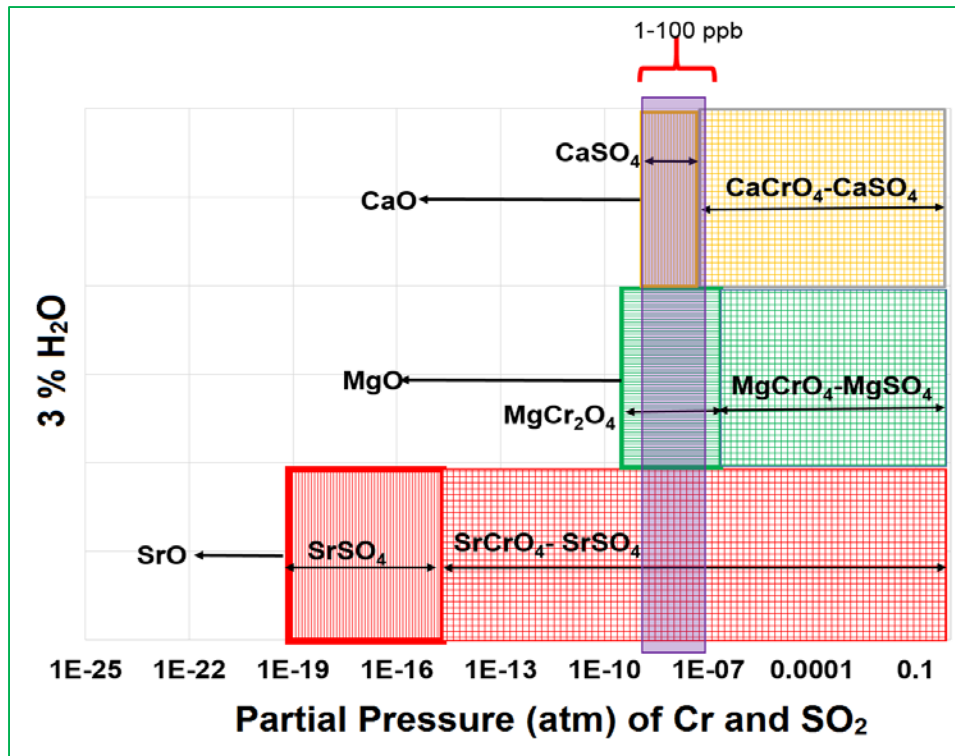

- Sr-Ni-O, Sr-Mn-O, Sr-Fe-O perovskite type compounds with relatively high electrical conductivity are the potential coating materials for getter application.
- CaO and MgO are considered.
- The oxidation of both Cr vapor and SO<sub>2</sub> occurs the most by SrO getter material over a wide temperature range.

Co-stability calculated based on Gibbs free energy and equilibrium constant

# Thermodynamic Calculations of $p_{Cr}$ and $p_{SO_2}$ vapors at High Temperatures

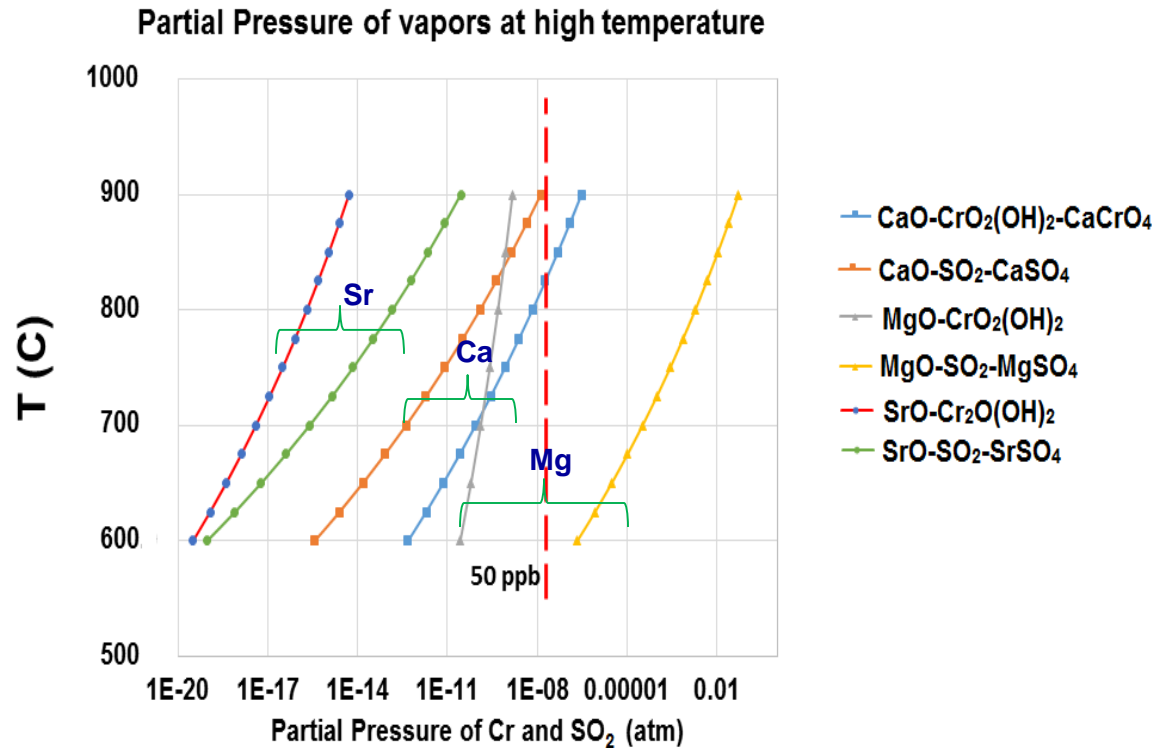

- SrO is better than CaO, and MgO as a getter material for Cr and S capture.
- SrO is capable of forming SrCrO<sub>4</sub> and SrSO<sub>4</sub> compounds at extremely low concentrations of Cr and SO<sub>2</sub> vapors, even below 1 ppb.



# Design and fabrication

- Sensor design:
  - Planar sensor design to monitor the presence of chromium within the getter

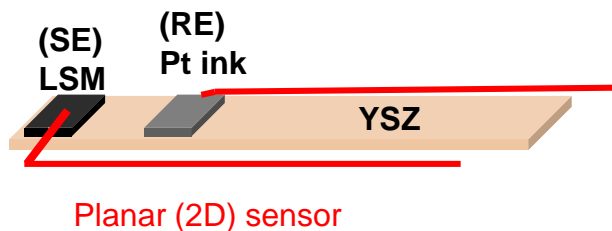

Sensor Fabrication

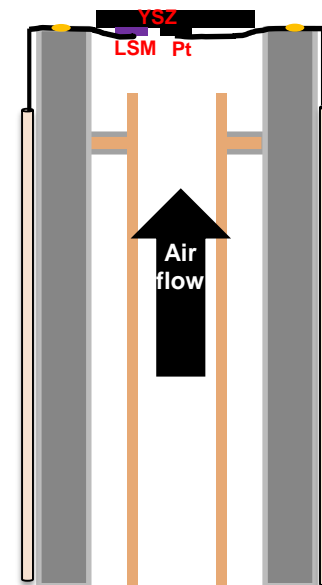

Sensor Validation

- LSM sintered at 1200 °C in air and Pt sintered at 850 °C in air with the ramp rate of 3C/min for 1h
- LSM and Pt ink was brush coated on the YSZ disk as sensing (SE) and reference electrode (RE)

# Validation

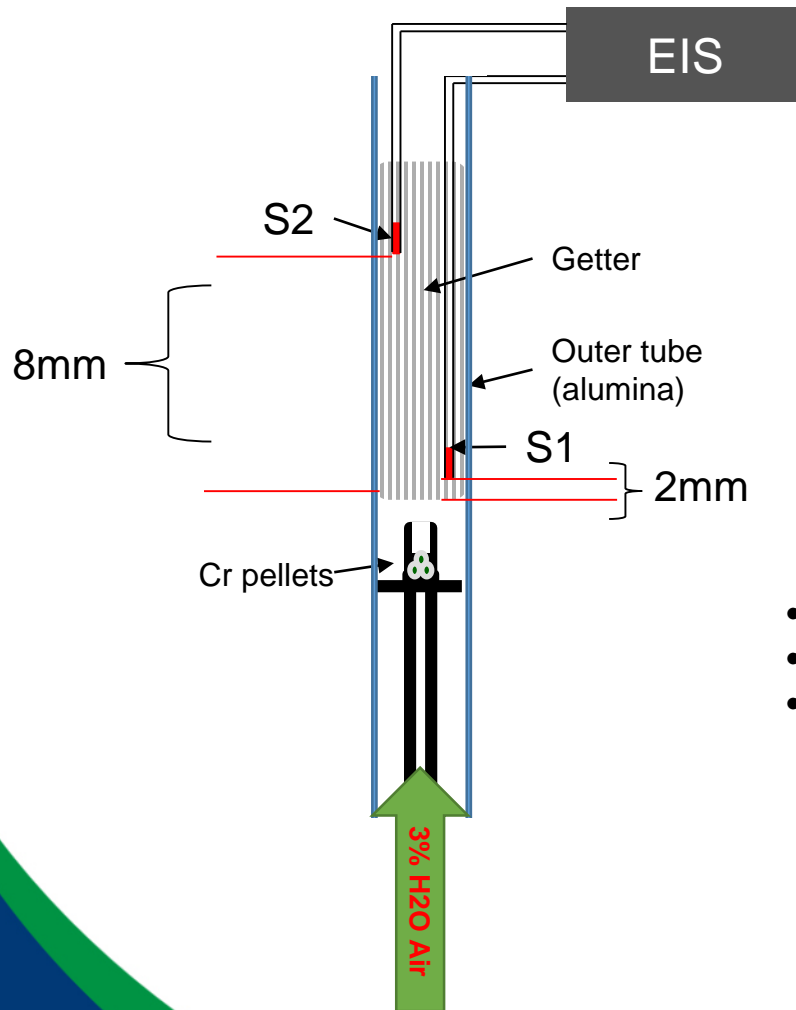

- S1 is inserted within the getter at about 2 mm from inlet
- S2 is inserted about 8 mm from inlet of the getter
- Observe the changes in polarization resistance and ohmic resistances to determine extent of Cr related degradation

# Governing Equations, Boundary Conditions, and Parameters

Mass conservation equation: 
$$\frac{\partial \rho}{\partial t} + \nabla \cdot (\rho \mathbf{u}) = 0$$

Momentum conservation equation: 
$$\frac{\partial (\rho \mathbf{u})}{\partial t} + \nabla \cdot (\rho \mathbf{u} \mathbf{u}) = -\nabla p + \nabla \cdot (\boldsymbol{\mu}^{eff} \nabla \mathbf{u}) + \rho \mathbf{g}$$

Species conservation equation: 
$$\frac{\partial (C^{Cr})}{\partial t} + \nabla \cdot (\mathbf{u} C^{Cr}) = \nabla \cdot (\mathbf{D} \nabla C^{Cr}) + S_{Cr}$$
  $S_{Cr}$ : sink term for Cr.

## Boundary Conditions

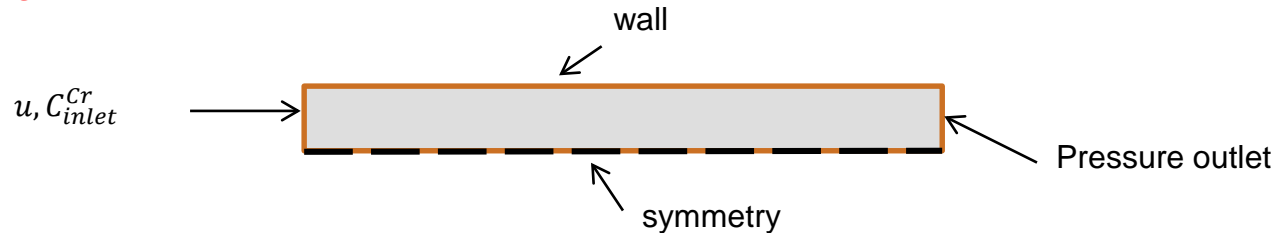

## Numerical Procedure

- Set of equations is discretized using a finite-volume method.
- Discretized equations are solved within the commercially available CFD software, Fluent, by customizing via user-defined functions.
- The software utilizes the well-known SIMPLE algorithm.

## Modeling Parameters

- Modeling Geometry: 50 mm long and 1mm width
- Temperature: 850°C
- Cr partial pressure 0.1 Pa and 0.001 Pa
- Air density: 0.3139 kg/m<sup>3</sup> at 850°C
- Gas phase Cr diffusivity: 1.08775e-4 m<sup>2</sup>/s
- Solid phase Cr diffusivity: 1e-19 m<sup>2</sup>/s
- Solid phase Sr diffusivity: 1e-17 m<sup>2</sup>/s

- Getter material: SrNiO<sub>x</sub>
- SrNiO<sub>x</sub> density: 5406 kg/m<sup>3</sup>
- SrNiO<sub>x</sub> molecular weight: 1.53542 kg/mol

# Electrode poisoning at low temperatures

In cell validation

# Electrochemical Performance at 650C

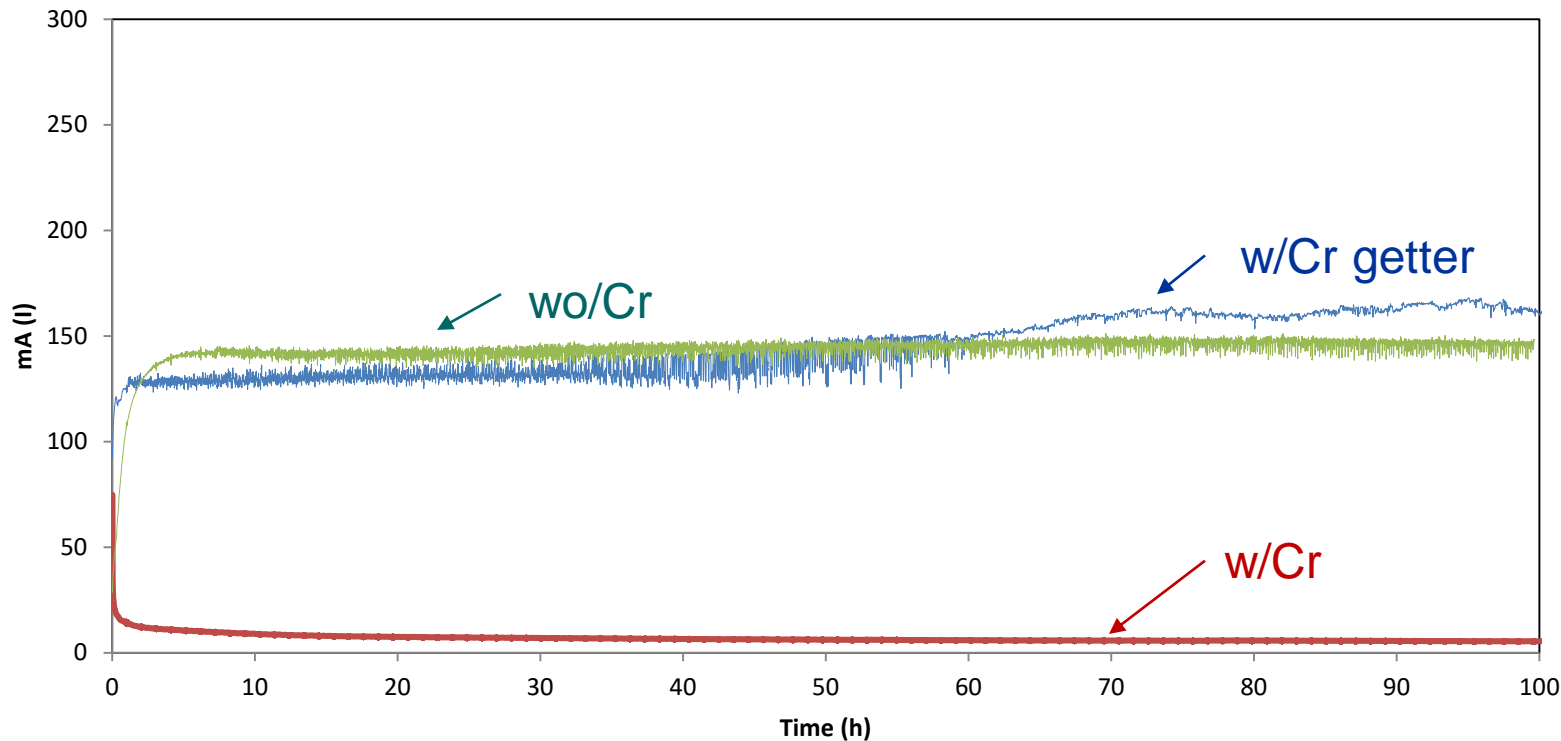

The LSM/YSZ/Pt half-cell exposed to 3% H<sub>2</sub>O/air in the presence of Cr vapor shows a rapid drop in the current within the first few hours while the I-t curves from the standard cell (No Cr vapor) and the cell exposure to Cr and followed a chromium getter show similar curve with stable electrochemical performance.

# Changes in EIS with/without Cr and Cr/getter

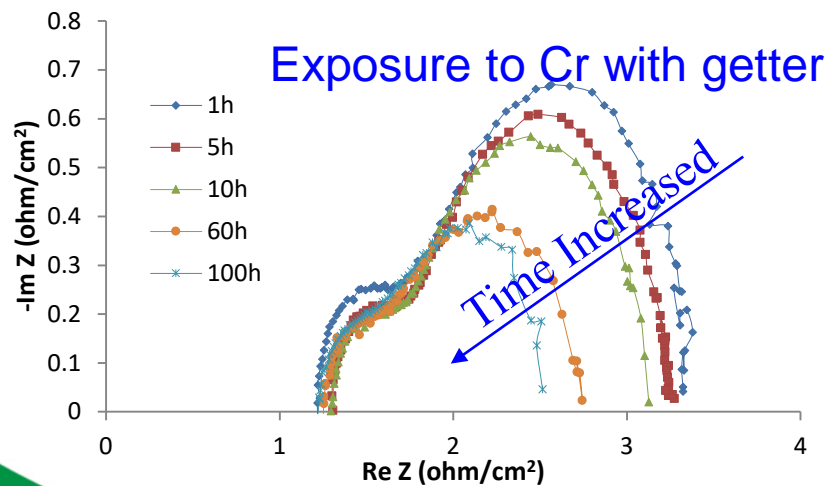
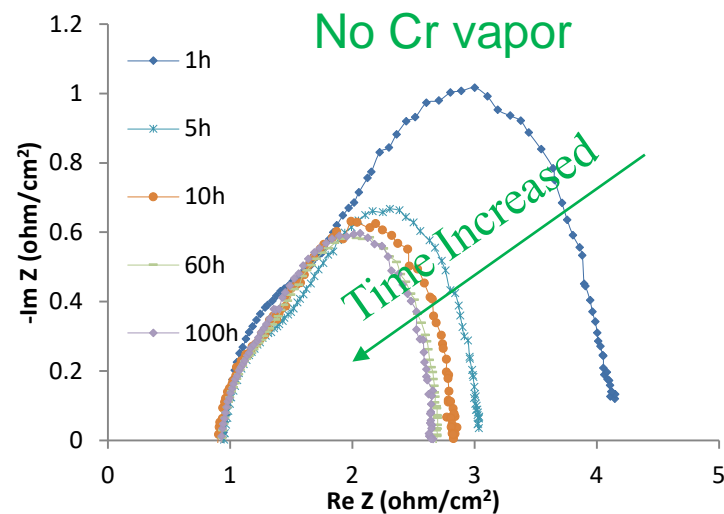
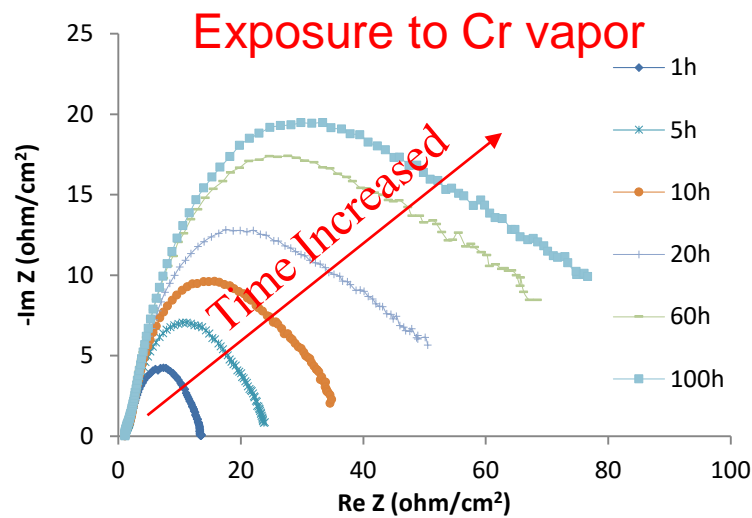

$R_p$  increases with time when cell was exposure to Cr while  $R_p$  keeps stable if no Cr species present.



# Cr deposition in the cell

Observations:  $\text{Cr}_2\text{O}_3$  deposits at the LSM/YSZ interface at  $650^\circ\text{C}$  when cell was exposed to Cr vapor.

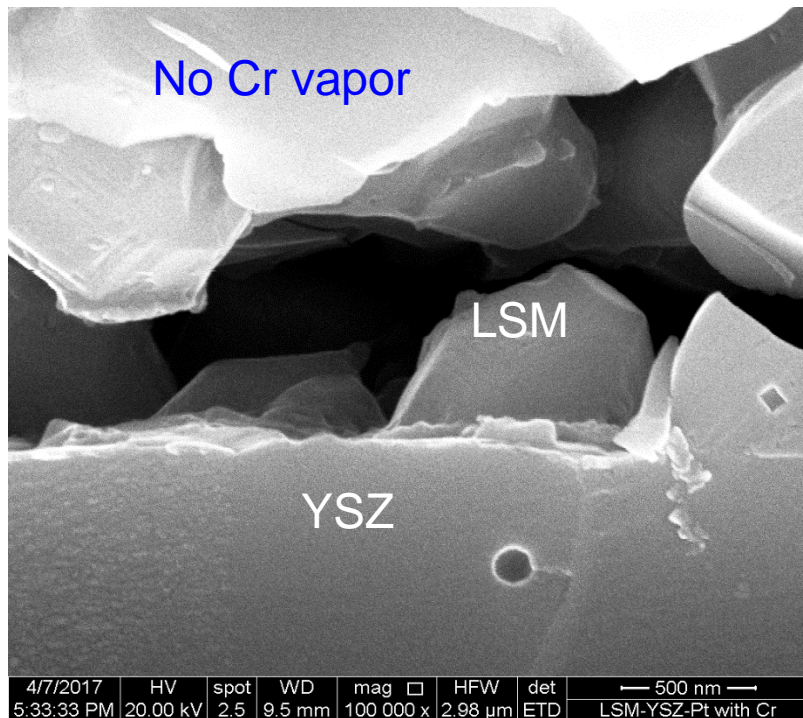

## EDS Quantitative Results

Element	Wt%	At%
SrL	19.85	20.60
LaL	53.32	34.90
CrK	0.94	1.65
MnK	25.89	42.85

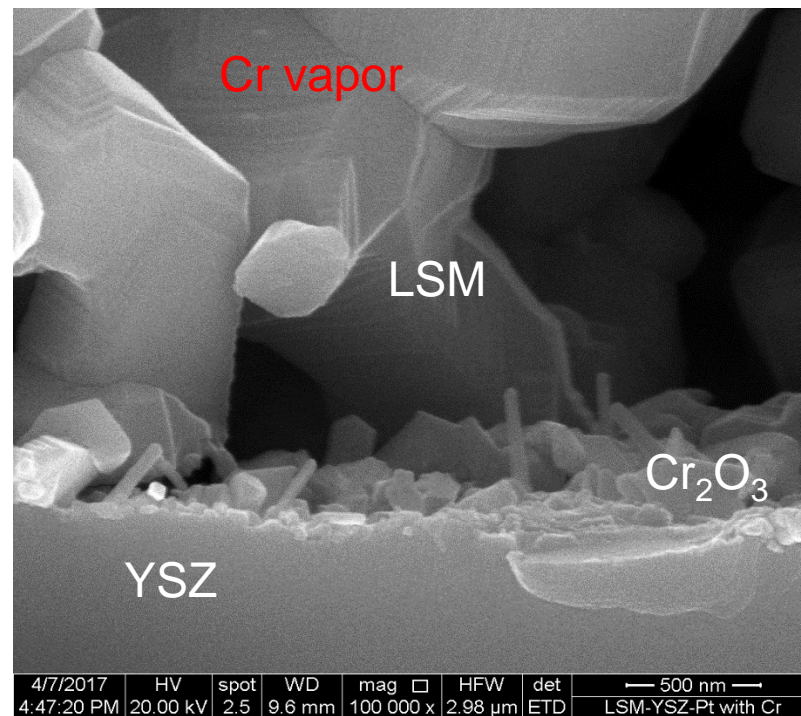

## EDS Quantitative Results

Element	Wt%	At%
SrL	19.19	18.52
LaL	46.55	28.33
CrK	4.96	8.06
MnK	29.30	45.09

# Summary

- **Cr capture has been successfully demonstrated from BOP/ In-cell sources**
- **Cr getter materials have been identified and synthesis process have been developed and scaled up.**
- **Synthesis process scaled up to 1kg/batch using lab equipment**
- **Design studies have been performed to obtain 40,000 hrs. getter life**
- **Fabricated Cr getter samples and materials have been provided to PNNL, LG, Cummins, Ceres and others for testing**
- **Laboratory findings have been provided to SOFC industries**
- **Cathode degradation mechanisms have been identified and published.**
- **Getter operation has been validated at low (650C) temperature**
- **Alternate HSA getter has been identified and synthesized.**

Getters can be provided to SOFC industries and research institutions for independent testing and validation

# Acknowledgements

- Drs. Rin Burke, Jason Lewis and Shailesh Vora for guidance and encouragement
- Dr. Jeff Stevenson, Matt Chou and Brian Koeppel (PNNL) for electrical testing and discussion
- Mr. Rich Goettler (LGFCs), Dr. Amit Pandey (LGFCs), Dr. Hossain Ghezel-Ayagh (FCE), Dr. Shubi Mukherjee (CP), Dr. Charles Veseley (CPS), Dr. Lou Carreiro (NUWC) and Dr. Deodeshmukh (Haynes) for engineering and systems related discussion
- Drs. Yu Zhong (FIU), Yoed Tsur(Technion) for thermochemical model
- UConn for providing laboratory facility and support

*Thank you*

# Getter Materials Optimization

## Electrical conductivity measurement: In-cell getter

### Composite with LSM – LSCF with SNO

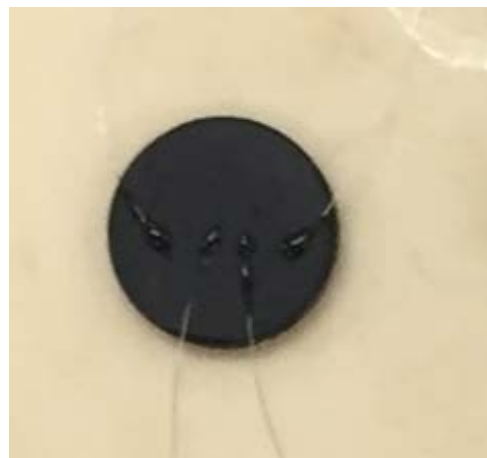
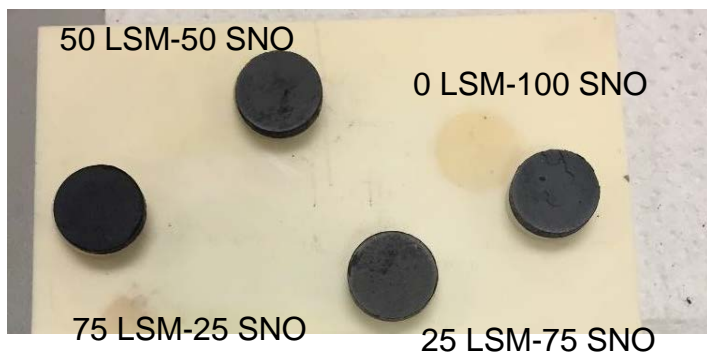

4 point probe method

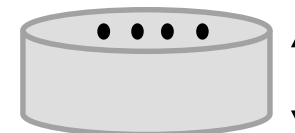

- LSM/ LSCF pellets were sintered at 1200°C
- LSM/LSCF-SNO composite pellets were sintered at 950°C for 1h
- Pt electrodes were attached using Pt paste and sintered at 850°C
- Pellet: Dia: ~12.70mm, Thickness: ~2.07mm, ~Wt: 0.9655g
- 4-probe measurement method applied

# Background: Getter

A list of Cr getter properties against the state of the art Cr poisoning mitigation and getter materials

Cr getter critical property	Performance of new Cr getter against baseline state of the art Cr getter	Test conditions (Temp, time, atm)
<b>Phase Stability</b>	Superior: New Cr getter shows no phase changes and interaction with humidity and CO <sub>2</sub> present in air.	RT-980C, Ambient air
<b>Reaction products</b>	As processed getters consist of several oxide phases containing Sr and Ni (Sr <sub>9</sub> Ni <sub>7</sub> O <sub>21</sub> , Sr <sub>4</sub> Ni <sub>3</sub> O <sub>9</sub> and Sr <sub>2</sub> Ni <sub>4</sub> O <sub>5</sub> ).	Powder synthesis process and transpiration, electrochemical testing at 850C for up to 500 hrs in Air -3%H <sub>2</sub> O
<b>Microstructures</b>	Stable powder, coating and substrate microstructures obtained New Cr getter retains its microstructure after high temperature exposures (850C) in humidified air. Literature review does not provide background information on the SOTA.	During processing up to 980C in air During bench top testing at 850C for up to 500 hrs in humid air
<b>Thermochemistry</b>	Similar or Superior: Based on thermochemical models developed	
<b>Physical Properties</b>	Similar or Superior: Based on resistance to ambient air (NAAQS)	
<b>Product morphology</b>	Porous powder coating on ceramic substrates	During processing up to 980C in air During bench top testing at 850C for up to 500 hrs in humid air
<b>Cr Conc. profile</b>	Superior: Capture Cr in the first 1500 - 3000 micron. Reproducible results	During bench top testing at 850C for up to 500 hrs in humid air
<b>Substrate</b>	Configuration include honeycomb, foam and fibrous structure, Substrate materials include Cordierite, Mullite, zirconia and alumina.	
<b>Ease of fabrication</b>	Conventional powder preparation and coating techniques	pre-formed /In-situ getter formation



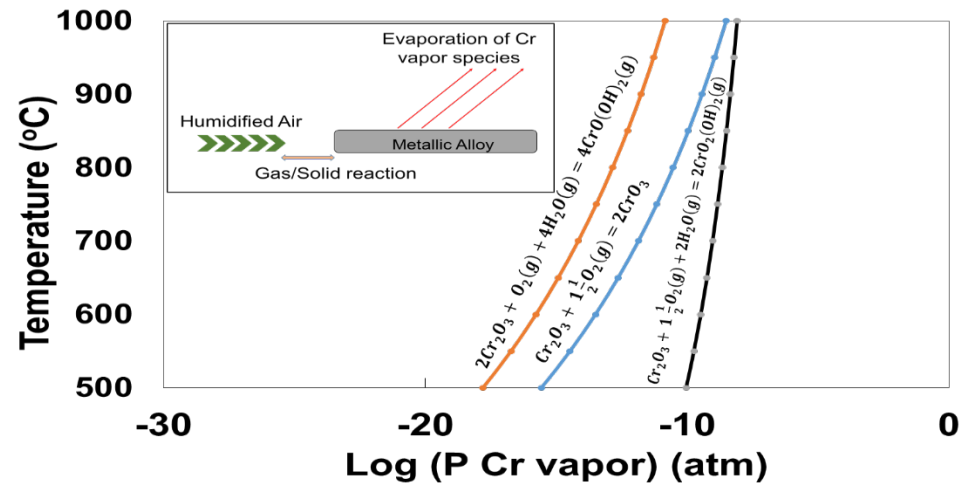

# Cr getter

## Appearance

1. Fabrication Process (coating x2)  
: Coating with  $\text{SrNi}(\text{OH})_x$  → sintering at 850 °C for 1 h → Coating with  $\text{SrNi}(\text{OH})_x$  → sintering at 650 °C for 1 h

→ Relatively, uniformly coated without any clogging

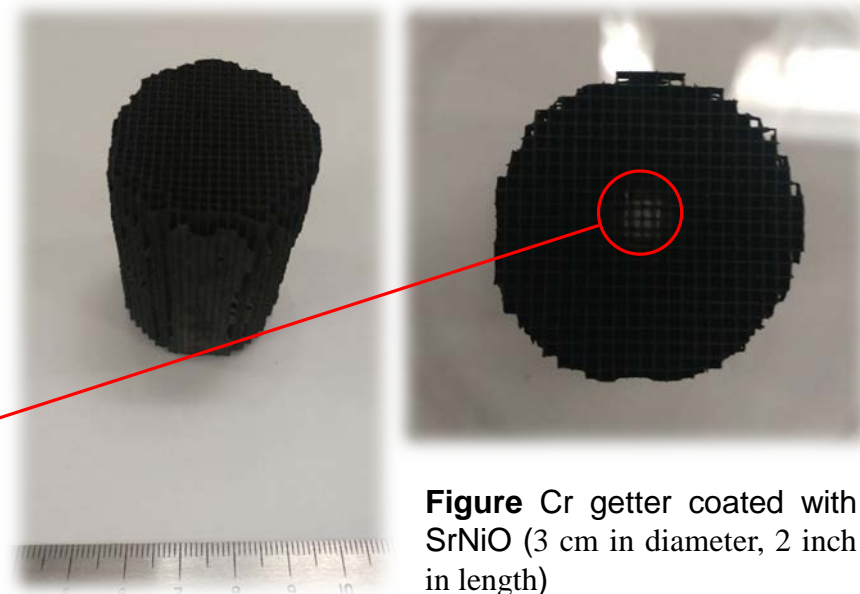
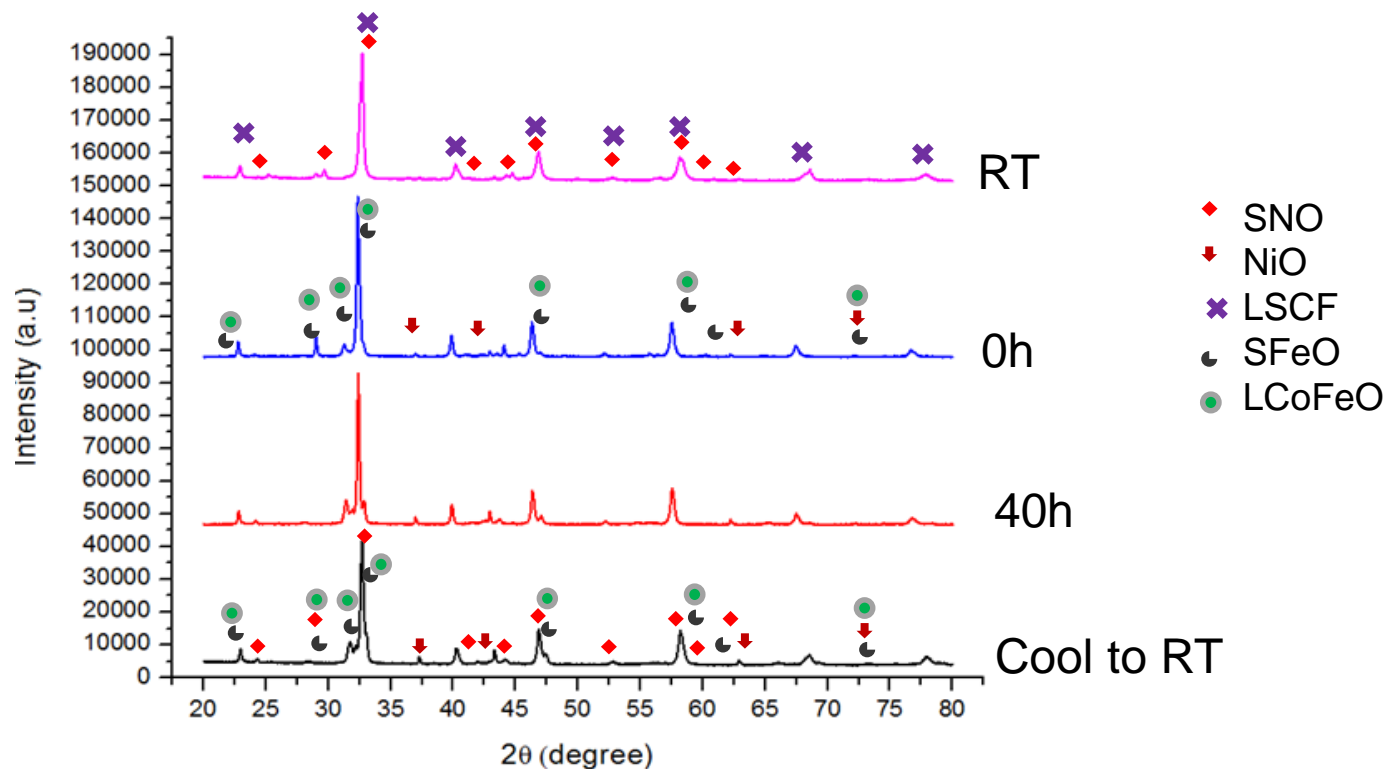

**Figure** Cr getter coated with  $\text{SrNiO}$  (3 cm in diameter, 2 inch in length)

2. Expectation from the appearance
  - (1) Black color in all positions → Uniformly coated
  - (2) No clogging → Uniform and ideal
  - (3) No powder dust detached from the getter → Strong adhesion

# Getter Materials Stability

High temperature *in-situ* XRD performed on 75LSCF-25SNO powder for up to 40h at 850 C



- SNO does not dissociate into SrO or NiO - indicating phase stability.
- LSCF remains stable throughout the 40h sintering process
- After 40h sintering strontium iron oxide (SFeO) and lanthanum cobalt iron oxide (LCoFeO) appeared in smaller quantity.

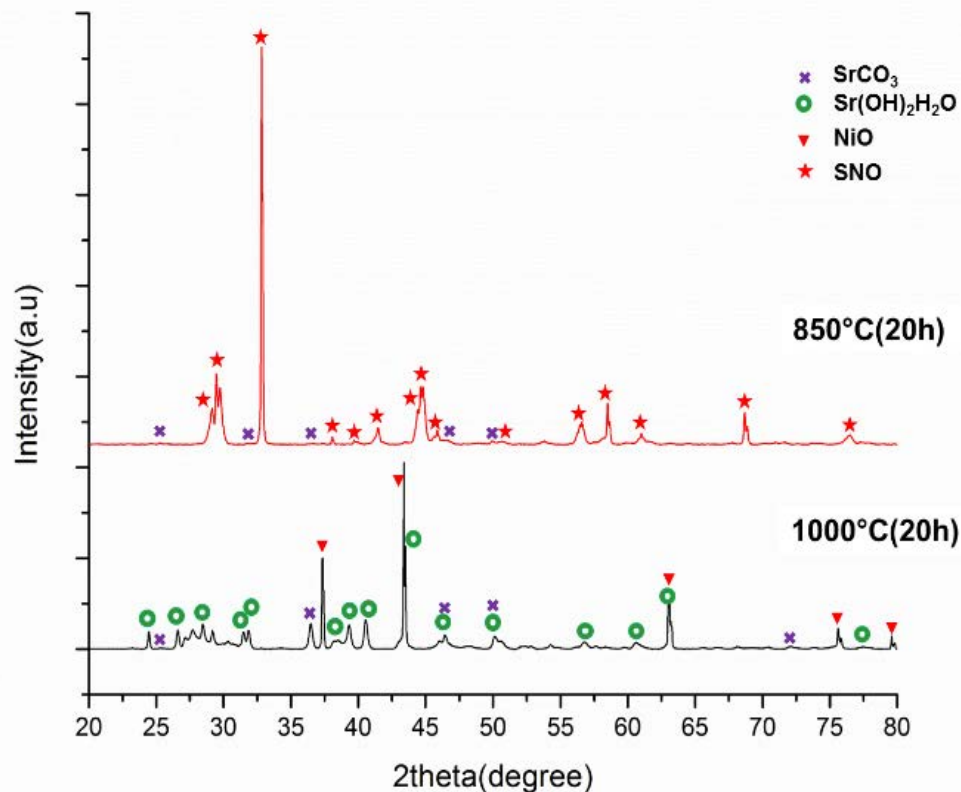
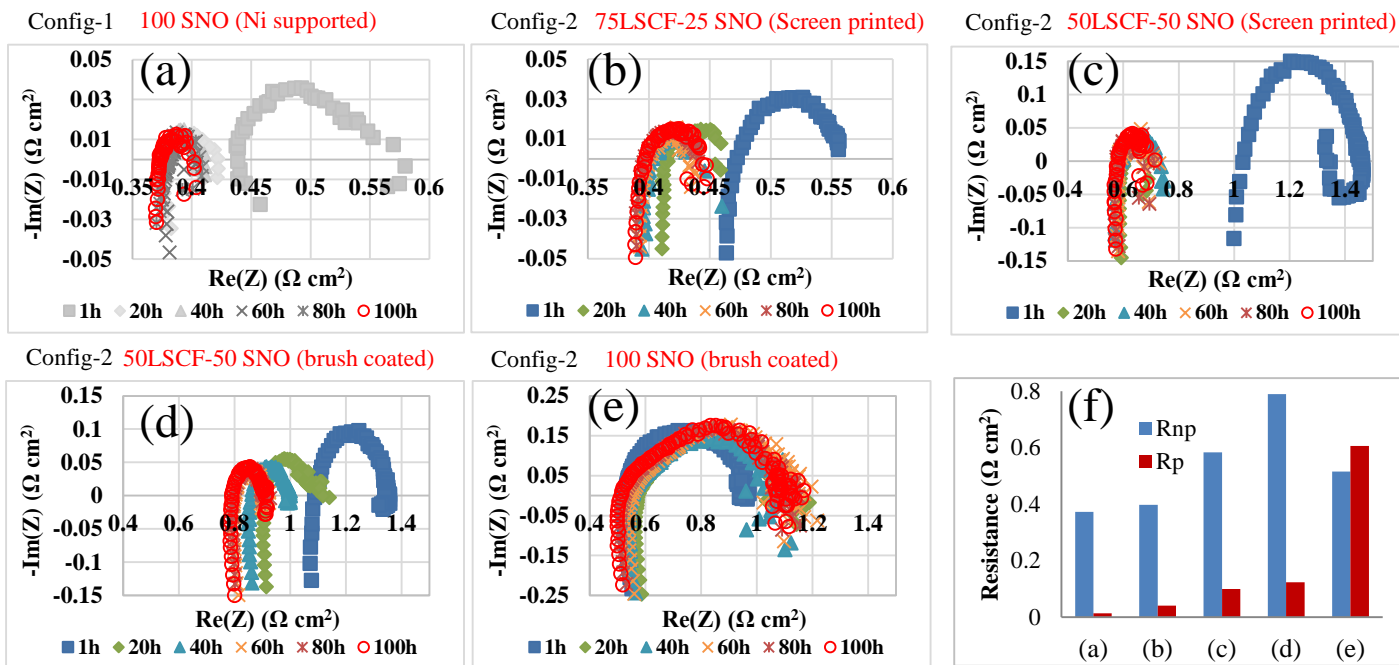

Figure 6. XRD patterns of SNO sintered at 850° C showing stability and showing the formation of  $\text{Sr(OH)}_2$  and  $\text{SrCO}_3$  compounds in the pulverized samples sintered at 1000° C for 20h.

# Electrochemical Evaluation

## Nyquist plots



- SNO getter (Config-1) half-cell shows least ohmic resistance and polarization and remained stable throughout
- 75LSCF-25SNO and 50LSCF-50SNO getter with (Config-2) half-cell demonstrated decrease in the ohmic resistance as well as polarization resistance during first 20h and later remained stable
- 100 SNO getter (Config-2) based half-cell has consistent ohmic resistance as well as polarization resistances, 0.6 and 1.5 ohms respectively

# Future Work

- Complete validation of 1 kg/ batch getter powder synthesis process
- Use the above getter powder for coating getter support (foam, honeycomb)
- Complete getter design
- Test coated getters under SOFC system conditions
- Test getters in the cell
- Provide powder and fabricated getters to SOFC industry under DOE guidelines
- Assist DOE in technology transfer



# I-t performance

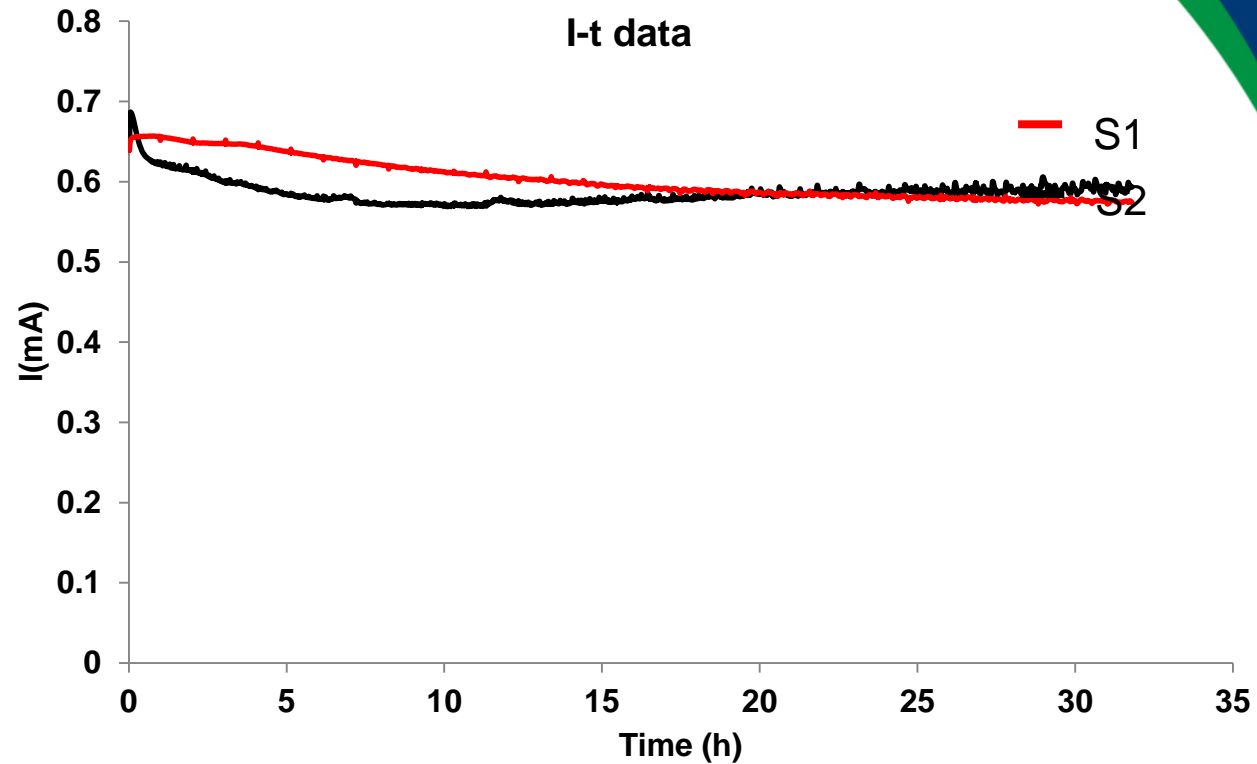

- Performance of S1 decreases continuously and S2 performance stabilizes after 5h

# Changes in $R_p$ and $R_{np}$

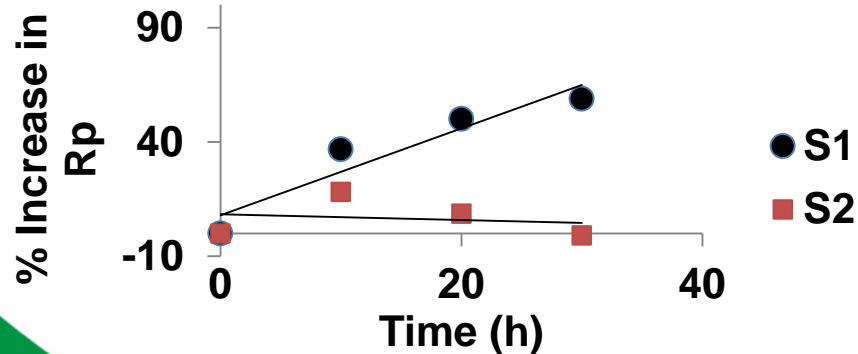
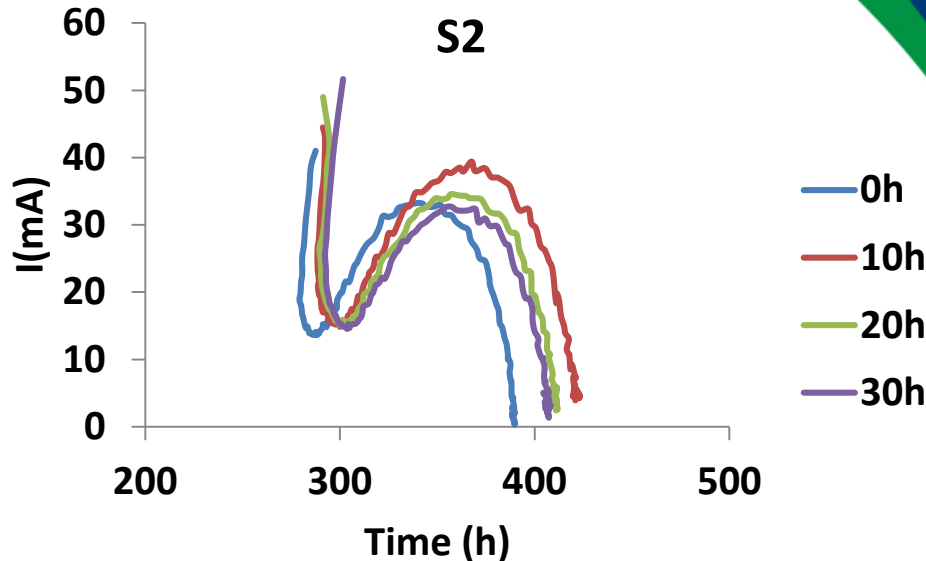
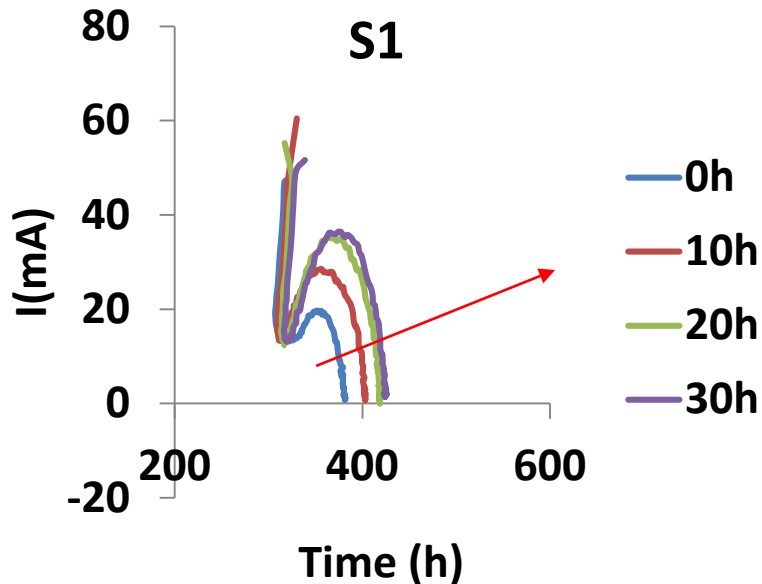

- Polarization resistance ( $R_p$ ) of S1 continuously increases and within 30h, it increased by more than 60%
- Increase in  $R_p$  of S2 is relatively stable over time.
- No significant changes in  $R_{np}$  for both sensor.
- Continue to monitor the performance over longer time

# Design and Optimization of Chromium Getter through Computational Modeling

# Design and Optimization of Chromium Getter through Computational Modeling

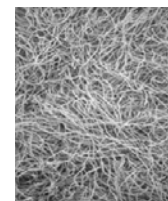
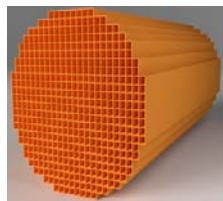

Aman Uddin  
Collaboration with PNNL

# Objectives

**The overall objective is to design and optimize chromium getter to capture the chromium species originating from the metallic stack and BOP components. The objectives include:**

- *Parametric study of getter to predict the effects of the key parameters such as geometric surface area, porosity, thickness of coating materials, etc. when:*
  - *Surface reaction is rate limiting*
  - *Solid state diffusion is rate limiting*
  - *Diffusion through porous product layer is rate limiting*
- Optimize design for higher utilization and low pressure drop requirement.
- Fabricate and test getter according to the proposed model and validate

- **A transient, two dimensional model of chromium getter is developed to predict the utilization of getter with various rate limiting cases.**
- **In this model, cordierite substrate with 400 cpsi (cells per square inch) is considered as the getter support material for 1 kW SOFC system (4 SLPM flow rate), and the model is solved for high Cr partial pressure (1e-6 atm).**
- **In solid state diffusion case, Chromium front moves forward before reaching to maximum capacity because porosity of getter decreases due to product layer formation with time and diffusion is rate limiting.**
- **Chromium front moves faster in solid state diffusion case compared to reaction rate limited case.**
- **Current efforts are underway to optimize design for higher utilization and low pressure drop requirement.**

# Background

- Cr poisoning is one of the major causes of cathode degradation in high temperature electrochemical systems such as SOFC.
- A novel approach called Cr getter is developed to mitigate the Cr poisoning.
- Cr getter contains SrNiOx getter material supported by various structure.
- Support materials: cordierite, porous alumina.
- Successfully captured Cr within 2-3mm of getter.

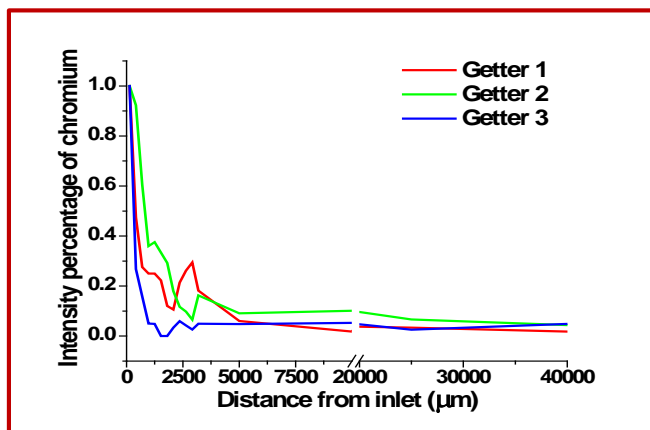
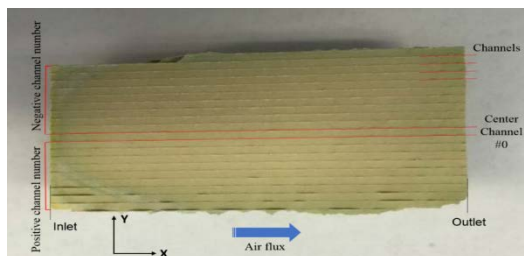
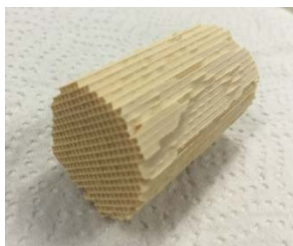

air flow rate of 300 sccm for 500hr at 850°C.

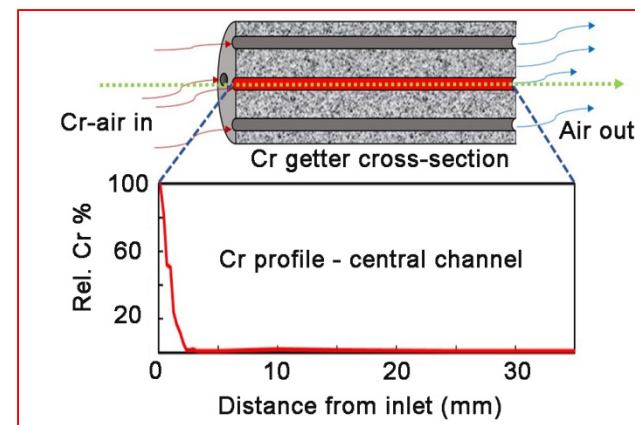

air flow rate of 50 sccm for 100hr at 850°C

Hu *et al.* J. Power Source, 2016, submitted



# Rate Limiting Step: Solid state diffusion

## Assumption:

- 10 $\mu$ m thick coating with 50% porosity
- Product layer reduces porosity of getter
- Solid State Diffusion 
$$S_{Cr} = D_e * \frac{C_{Sr}}{\delta(t)} * \frac{A}{V}$$

Where,  $C_{Sr}$ =concentration of Strontium,  $D_e$ = Diffusion coefficient;  $\delta(t)$ =thickness product layer,  $A/V$ = area to volume ratio

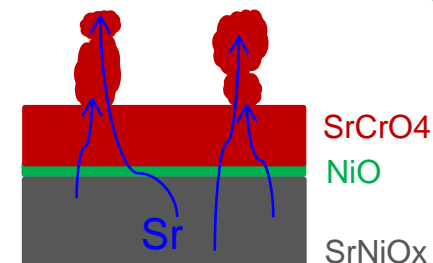

Chromium profile at 4 SLPM flow rate with 0.1 Pa Cr pressure

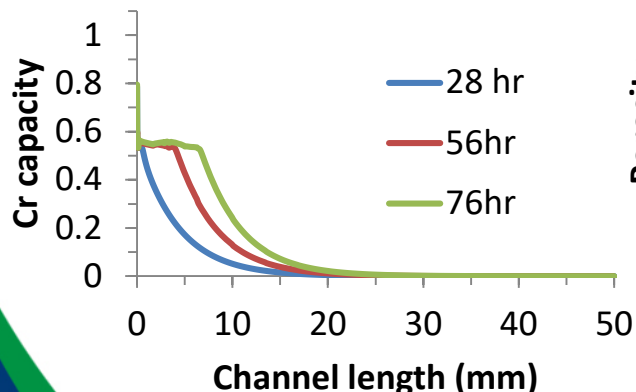

Porosity of getter

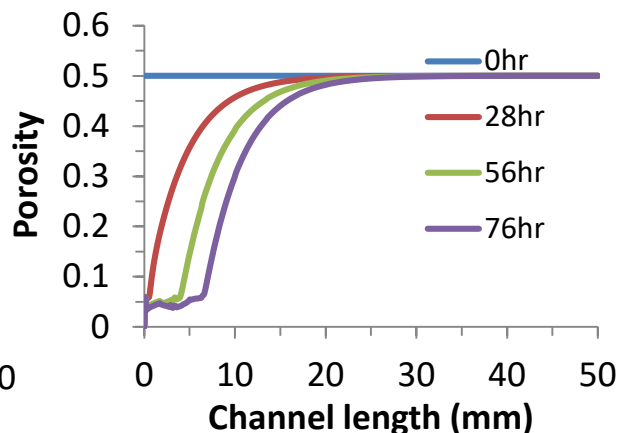

Comparison (after 56hr)

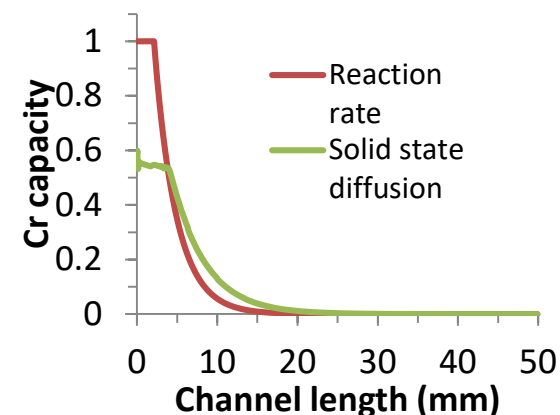

- Chromium front moves forward before reaching to maximum capacity because porosity of getter decreases and diffusion is rate limiting.
- Chromium front moves faster in solid state diffusion case compared to reaction rate limited case.

# Electrochemical Performance (Baseline- No Cr-No Getter)

## I-t data

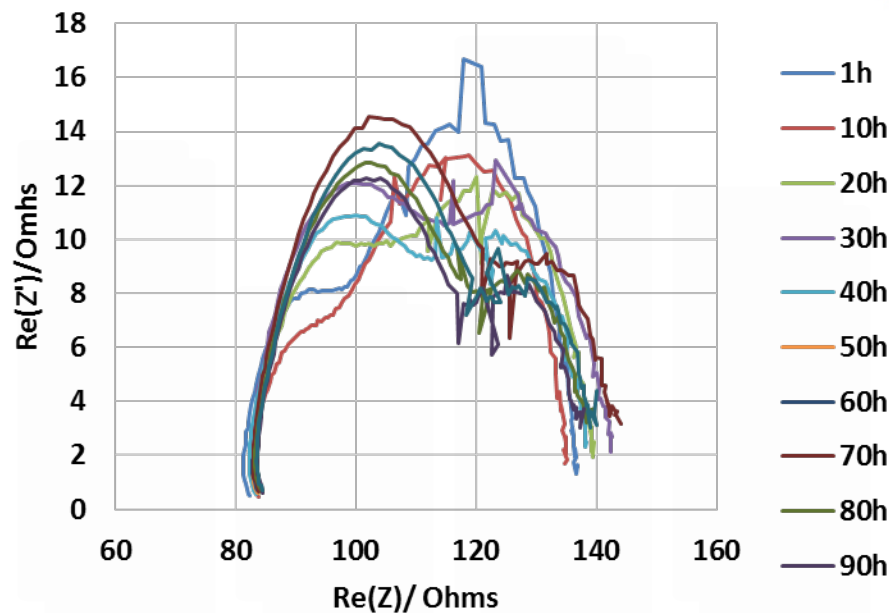
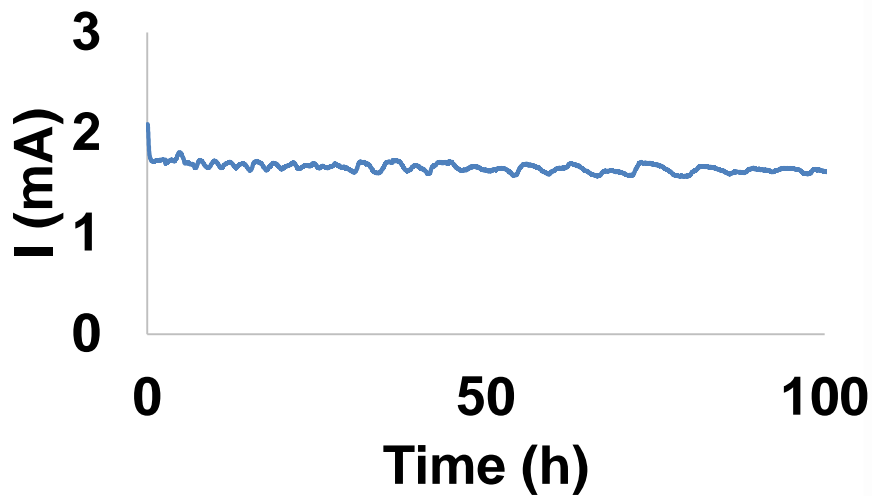

- Results from 100 h I-t data shows stable performance
- Polarization resistance remained stable at ( $R_p$ )  $\sim 60 \Omega$
- Ohmic resistance also remains constant at ( $R_{np}$ )  $\sim 80 \Omega$

# Electrochemical Performance (Cr- No Getter)

I-t-data (Cr-NO getter)

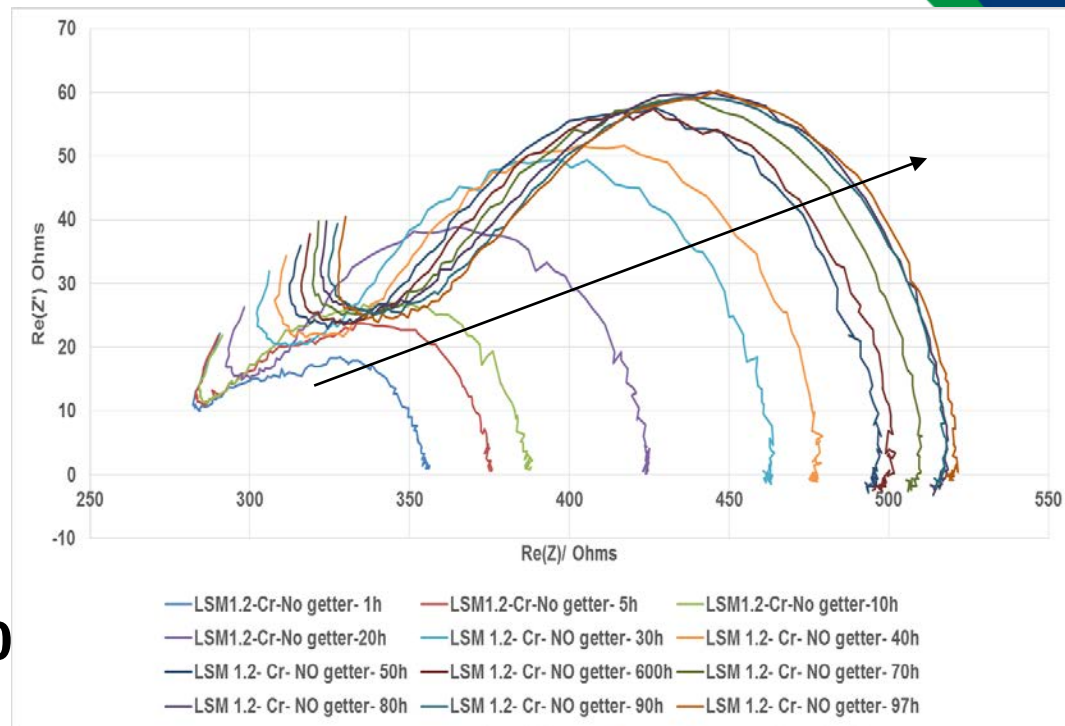
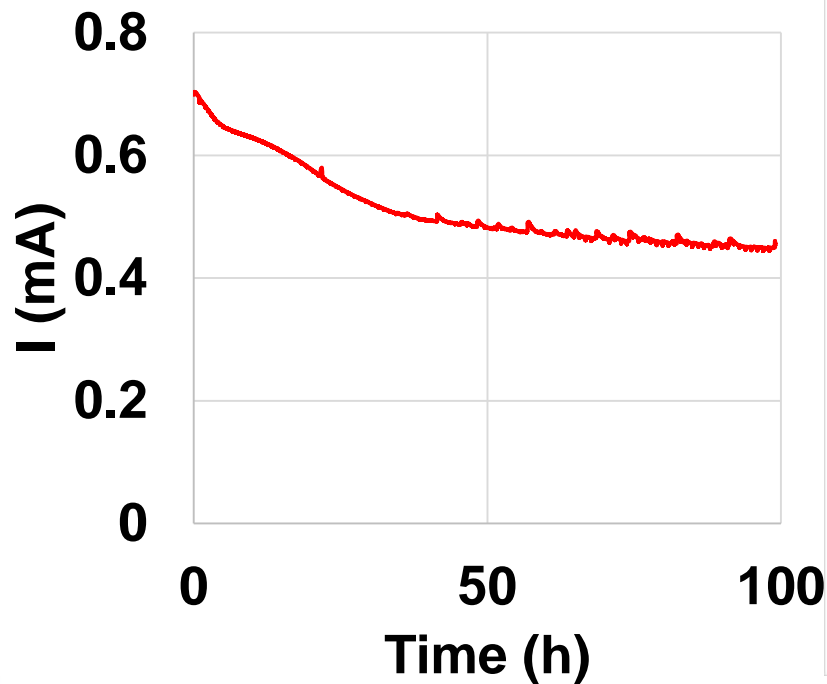

- LSM degrades rapidly after the exposure to Cr vapor
- Nyquist plot indicate continuous increase in the polarization resistance due to Cr degradation

# Acknowledgements

- **Helpful technical feasibility discussions with Dr. Rin Burke**
- **Systems and applications related discussion**
  - **Drs. Goettler, Ghezel-Ayagh, Aligner, Mukherjee**
  - **Provided experimental data to LGFC, FCE, GE, Ceres Power**
  - **Discussed scale-up issues**
  - **Discussed system constraints and experimental parameters**
- **Cell and stack related discussion with Dr. Stevenson**
  - **Provided getter materials and performance data**
  - **Discussed approaches for application in cells**